



改變從現在開始 品質在這裡體現

A thick, 3D-style green ring is positioned diagonally across the page, overlapping the red banner and the white background.

 **選型手冊**



Change from now on
Quality is reflected here

公司簡介

Company Profile

歐博斯是一家密封件專業生產廠家,專業生產用於機械,油壓,氣動,電子密封。

我們經常搭配客戶量身訂做開發所需之密封件產品。

生產品項有:O型圈,X型圈,骨架油封,PU油封,PTFE擋圈,氣彈簧密封圈,APA,PDU,DKB...密封特殊件等。



我們的競爭優勢 Our Advantage

- 我們擁有各國標準的O-RING模具,包括常用的AS568美標,日本P,G,V,S標準,中國C92標準,且非標準O型圈內徑300mm以下不收模具費。O-RING的材質多樣化,還可以根據客戶不同的要求去生產。
- 為了能及時的為中國大陸市場提供產品及服務,歐博斯公司在南京設有分公司,南京歐博斯橡膠製品有限公司。
- 我們目前客戶涵蓋的行業有:氣彈簧,電磁閥,油路閥,氣壓缸,油壓缸,齒輪箱,齒輪泵,真空泵,隔膜泵,減速機,空調,食品機械,醫療機械,機床,汽車,化工...
- 歐博斯絕對是搭配您研發及OEM優良的供應廠家。



目錄索引 Contents

▶ 技術資料

橡膠材質物性報告	02
橡膠材質描述	03

▶ O型圈/星型圈

O型圈/星型圈概述	05
O型圈/星型圈選擇考慮的因素	06
影響密封圈性能的其他因素	07
O型圈安裝設計	08
O型圈的安裝、貯存	10
O型圈/星型圈開槽尺寸	11
美國國家標準 (AS 568) 尺寸表	13
中國國家標準 (GBT 3452.1) 尺寸表	25
日本國家標準 (JISB 2401) 尺寸表	34

▶ 骨架油封

骨架油封技術參數	49
骨架油封尺寸表	50
華司油封尺寸表	57
橡膠擋圈尺寸表	61
管接頭密封尺寸表	63
VA水封尺寸表	64
VS水封尺寸表	67

▶ 油壓密封

油缸示意圖	70
(DHS) 型聚氨酯油封尺寸表	71
(UPI) 型聚氨酯油封尺寸表	72
(USH) 橡膠密封圈尺寸表	87
(LBH) 橡膠密封圈尺寸表	88

▶ 氣彈簧密封

氣彈簧參數	90
-------------	----



技术资料 

橡膠材質物性報告

材料名稱 物性級別 物性要求	丁腈橡膠	氯化丁腈橡膠	三元乙丙橡膠	硅矽橡膠	氯丁橡膠	氟素橡膠	氟矽橡膠	全氟橡膠	聚四氟乙烯	聚氨酯	天然橡膠	丁基橡膠
	NBR (N)	HNBR (N)	EPDM (E)	VMQ (SI)	CR (C)	FKM (V) VITON	FVMQ (F)	FFKM (K)	PTFE (T)	PU (U)	NR (R)	IIR (I)
抗臭氧性	C	A	A	A	A B	A	A	A	A	A	D	B
耐候性	B	A	A	A	B	A	A	A	A	B	D	A
耐熱性	120°C	150°C	150°C	220°C	120°C	200°C	175°C	320°C	280°C	90°C	90°C	120°C
耐化學藥品性	B C	B	A	A B	B C	A B	A	A	A	A	D	B
耐油性	A	A	D	B C	B C	A	A	A	A	A	D	D
密水性	B	B	A	B	B	A	C	A	A	A	A	A
耐寒性	-40°C	-40°C	-50°C	-60°C	-40°C	-20°C	-60°C	-20°C	-100°C	-40°C	-60°C	-50°C
耐磨損性	B	A B	B	D	B	A B	D	A	A	A	A B	B
抗變形性	A B	B	A B	A	C	B	A	A	D	D	A B	B
耐酸性	C	B	A B	C	B C	A	A	A	A	D	B C	B
耐鹼性	B	A B	A	C	A B	A B	C	A	A	D	C	A
張力強度	A B	A B	A B	D	A B	A B	B	A B	C D	A	A	B
耐水蒸汽性	D	B C	A B	B C	C	B C	B C	A	B	D	D	B C
抗燃性	D	D	D	C D	B	A	C D	A	A	C	D	C D
儲存穩定性 (Y=年)	5~10Y	5~10Y	5~10Y	ABT20Y	5~10Y	ABT20Y	ABT20Y	ABT20Y	ABT20Y	ABT20Y	3~5Y	5~10Y

注：A -特佳 B -佳 C -普通 D -差

硬度表

硬度 (SHORE A)	硬度 (IRHD)	适用范围
40+/-5	/	低压情况下需高度 密封条件下使用
50+/-5	/	
60+/-5	63+/-5	
70+/-5	73+/-5	一般情况下之密封
80+/-5	83+/-5	高压情况下之密封
90+/-5	93+/-5	

橡膠材質描述

NBR丁腈橡膠密封圈：適合於石油系液壓油、甘醇系液壓油、二酯系潤滑油、汽油、水、矽潤滑脂、矽油等介質中使用。是目前用途最廣、成本最低的橡膠密封件。不適用於極性溶劑之中，例如酮類、臭氧、硝基烴、MEK 和氯仿。一般使用溫度範圍為 $-40\sim 120\text{ }^{\circ}\text{C}$ 。

HNBR氫化丁腈橡膠密封圈：具有極佳的抗腐蝕、抗撕裂和抗壓縮變形特性，耐臭氧、耐陽光、耐天候性較好。比丁腈橡膠有更佳的抗磨性。適用於洗滌機械、汽車發動機系統及使用新型環保冷媒 R134a的製冷系統中。不建議使用於醇類、酯類或是芳香族的溶液中。一般使用溫度範圍為 $-40\sim 150\text{ }^{\circ}\text{C}$ 。

SIL矽矽橡膠密封圈：具有極佳的耐熱、耐寒、耐臭氧、耐大氣老化性能。有很好的絕緣性能。但抗拉強度較一般橡膠差且不具耐油性。適用於家用電器如電熱水器、電熨斗、微波爐等。還適用於各種與人體有接觸的用品，如水壺、飲水機等。不建議使用於大部份濃縮溶劑、油品、濃酸及氫氧化鈉中。一般使用溫度範圍為 $-60\sim 220\text{ }^{\circ}\text{C}$ 。

VITON氟素橡膠密封圈：耐高溫性優於矽橡膠，有極佳的耐候性、耐臭氧性和耐化學性，耐寒性則不良。對於大部份油品及溶劑都具有抵抗能力，尤其是酸類、脂族烴、芳香烴及動植物油。適用於柴油發動機、燃料系統及化工廠的密封需求。不建議使用於酮類、低分子量的酯類及含硝的混合物。一般使用溫度範圍為 $-20\sim 200\text{ }^{\circ}\text{C}$ 。

FLS氟矽橡膠密封圈：其性能兼有氟素橡膠及矽橡膠的優點，耐油、耐溶劑、耐燃料油及耐高低溫性均佳。能抵抗含氧的化合物、含芳香烴的溶劑及含氯的溶劑的侵蝕。一般用於航空、航太及軍事用途。不建議暴露於酮類及剎車油中。一般使用溫度範圍為 $-60\sim 175\text{ }^{\circ}\text{C}$ 。

EPDM三元乙丙橡膠密封圈：具有很好的耐候性、耐臭氧性、耐水性及耐化學性。可用於醇類及酮類，還可用於高溫水蒸氣環境之密封。適用於衛浴設備、汽車散熱器及汽車剎車系統中。不建議用於食品用途或是暴露於礦物油之中。一般使用溫度範圍為 $-50\sim 150\text{ }^{\circ}\text{C}$ 。

CR氯丁橡膠密封圈：耐陽光、耐天候性能特別好。不怕二氯二氟甲烷和氨等製冷劑，耐稀酸、耐矽脂系潤滑油，但在苯胺點低的礦物油中膨脹量大。在低溫時易結晶、硬化。適用於各種接觸大氣、陽光、臭氧的環境及各種耐燃、耐化學腐蝕的密封環節。不建議使用於強酸、硝基烴、酯類、氯仿及酮類的化學物之中。一般使用溫度範圍為 $-40\sim 120\text{ }^{\circ}\text{C}$ 。

IIR丁基橡膠密封圈：氣密性特別好，耐熱、耐陽光、耐臭氧性佳，絕緣性能好；對極性溶劑如醇、酮、酯等有很好的抵抗能力，可暴露於動植物油或可氧化物中。適合於耐化學藥品或真空設備。不建議與石油溶劑、煤油或芳烴同時使用。一般使用溫度範圍為 $-50\sim 120\text{ }^{\circ}\text{C}$ 。

ACM丙烯酸脂橡膠密封圈：對油品有極佳的抵抗力，耐高溫、耐候性均佳，但機械強度、壓縮變形率及耐水性稍差。一般用於汽車傳動系統及動力轉向系統之中。不適用於熱水、剎車油、磷酸酯之中。一般使用溫度範圍為 $-25\sim 170\text{ }^{\circ}\text{C}$ 。



O型圈/星型圈

一 概 述

特點:

O形密封圈由於它製造費用低及使用方便，因而被廣泛應用在各種動、靜密封場合。

標準:

大部分國家對 O形密封圈都制定係列產品標準，其中美國標準（AS 568）、日本標準（JIS B 2401）、國際標準（ISO 3601/1）較為通用。

■表1 O型圈標準一覽表

標準	O型圈界面直徑 CS
美國標準 AS 568	1.78 2.62 3.53 5.33 6.99
英國標準 BS 1516	
日本標準 JIS B 2401	1.90 2.40 3.10 3.50 5.70 8.40
國際標準 ISO 3601/1	1.80 2.65 3.55 5.30 7.00
德國標準 DIN 3771/1	
中國標準 GB 3452.1	
優先的米製尺寸	1.00 1.50 2.00 2.50 3.00
	3.50 4.00 4.50 5.00 5.50
	6.00 7.00 8.00 10.00 12.00

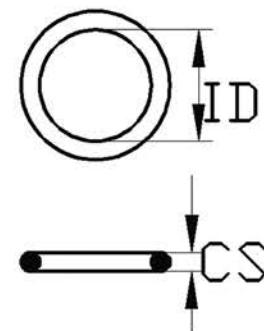

密封機理

O形密封圈是一種自動雙向作用密封元件。安裝時其徑向和軸向方面的預壓縮賦與O形密封圈自身的初始密封能力。它隨系統壓力的提高而增大。

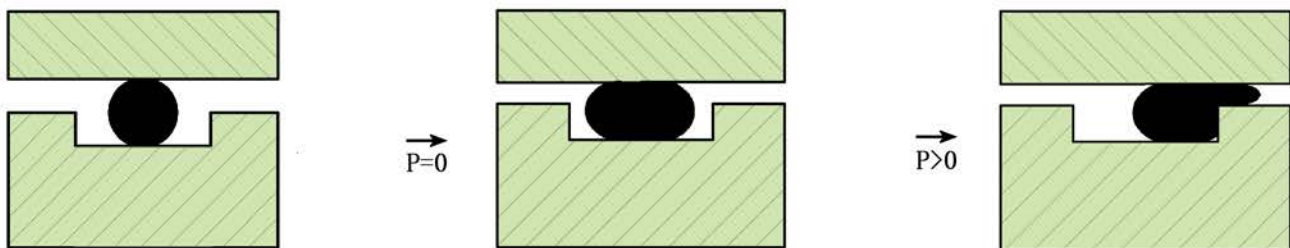

(A) 无压缩状态

(B) 无压力作用下的压缩状态

(C) 无压作用

■性能參數

	靜態密封	動態密封
工作壓力	無擋圈時，最高可達 20MPa； 有擋圈時，最高可達 40MPa； 用特殊擋圈時，最高可 200MPa	無擋圈時，最高可達 5Mpa； 有擋圈時，較高壓力
運動速度	最大往復速度可達 0.5m/s，最大旋轉速度可達 2.0m/s	
溫度	一般場合：-30℃～+110℃；	
	特殊橡膠：-60℃～+250℃；	
	旋轉場合：-30℃～+80℃	
介質	見橡膠密封材料物性	

二. O形密封圈選擇應考慮的因素

1、工作介質和工作條件

在具體選取O形圈材料時，首先要考慮與工作介質的相容性。還須綜合考慮其密封處的壓力、溫度、連續工作時間、運行週期等工作條件。若用在旋轉場合，須考慮由於摩擦熱引起的溫升。不同的密封件材料，其物理性能和化學性能都不一樣。

2、密封形式

按負載類型可分為靜密封和動密封；按密封用途可分為孔用密封、軸用密封和旋轉軸密封；按其安裝形式又可分為徑向安裝和軸向安裝。徑向安裝時，對於軸用密封，應使O形圈內徑和被密封直徑 d_2 間的偏差盡可能地小；對於孔用密封，應使其內徑略小於溝槽的直徑 d_1 。

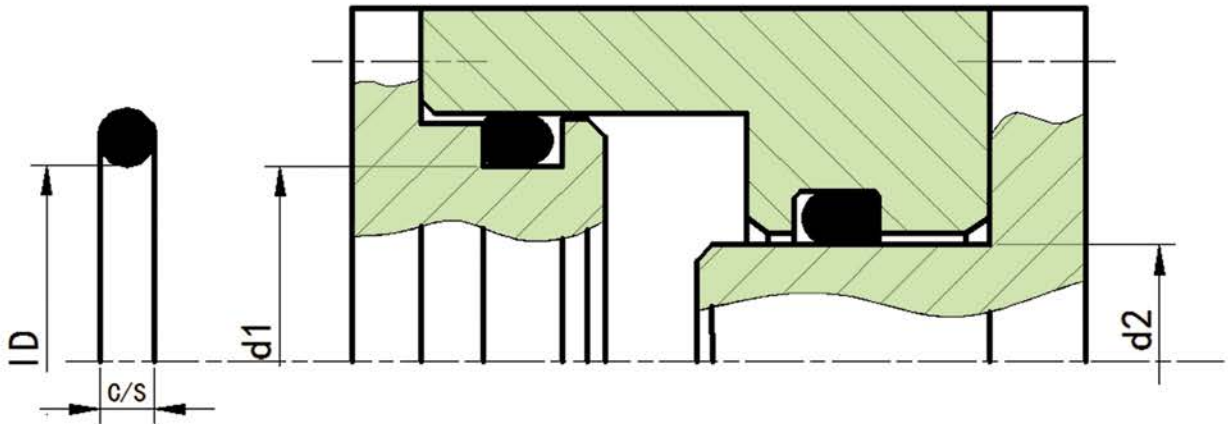

徑向安裝，靜密封和動密封

軸向安裝時，要考慮壓力方向。內部壓力時，O形圈外徑應比溝槽外徑 d_3 約大1~2%；外部壓力時，應使O形圈內徑比溝槽內徑 d_4 約小1~3%。

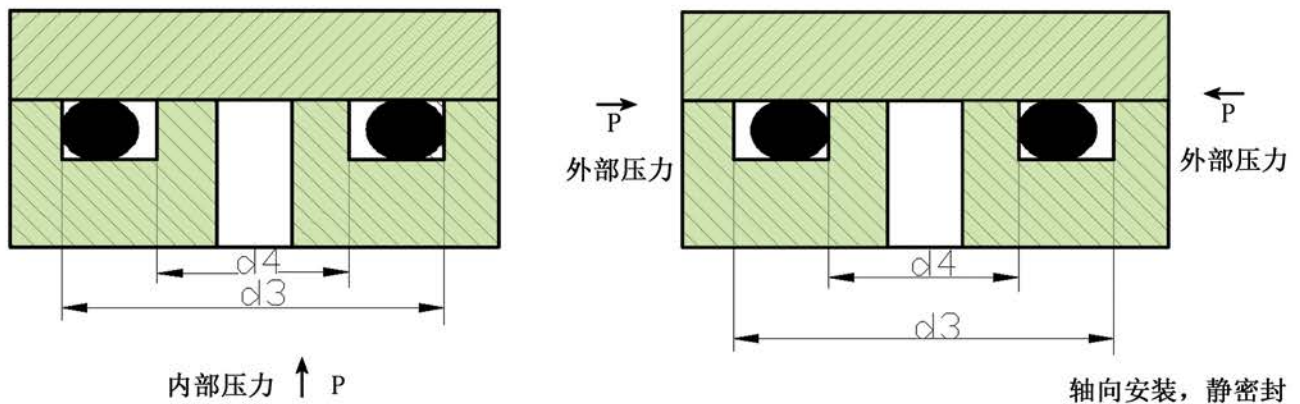

內部壓力 ↑ P

軸向安裝，靜密封

三. 影響密封性能的其他因素

1、O形圈的硬度

O形圈材料硬度是評定密封性能最重要的指標。O形圈的硬度決定了O形圈的壓縮量和溝槽最大允許擠出間隙。

2、擠出間隙

最大允許擠出間隙 g_{max} 和系統壓力，O形圈截面直徑以及材料硬度有關。通常，工作壓力越高，最大允許擠出間隙 g_{max} 取值越小。如果間隙 g 超過允許範圍，就會導致O形圈擠出甚至損壞。

■ 表2最大允許擠出間隙 g_{max}

壓力 Mpa	O型圈界面直徑 W				
	1.78	2.62	3.53	5.33	6.99
邵氏硬度 A70					
≤3.50	0.08	0.09	0.10	0.13	0.15
≤7.00	0.05	0.07	0.08	0.09	0.10
≤10.50	0.03	0.04	0.05	0.07	0.08
邵氏硬度 A80					
≤3.50	0.10	0.13	0.15	0.18	0.20
≤7.00	0.08	0.09	0.10	0.13	0.15
≤10.50	0.05	0.07	0.08	0.09	0.10
≤14.00	0.03	0.04	0.05	0.07	0.08
≤17.50	0.02	0.02	0.03	0.03	0.04
邵氏硬度 A90					
≤3.50	0.13	0.15	0.20	0.23	0.25
≤7.00	0.10	0.13	0.15	0.18	0.20
≤10.50	0.07	0.09	0.10	0.13	0.15
≤14.00	0.05	0.07	0.08	0.09	0.10
≤17.50	0.04	0.05	0.07	0.08	0.09
≤21.00	0.03	0.04	0.05	0.07	0.08
≤35.00	0.02	0.03	0.03	0.04	0.04

※當壓力超過5MPa時，建議使用擋圈。

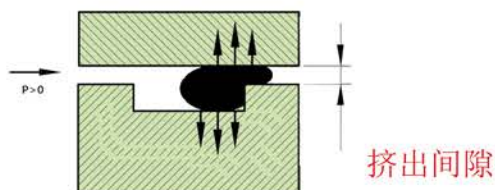

四、O形圈安裝設計

O形圈安裝在溝槽內時，應允許它有一定的膨脹空間。通常，允許的膨脹率在靜密封中約為15%，在動密封中約為8%。對於不同類型的溝槽，其適用範圍也不相同。常用的溝槽形式有三種：

a三角溝槽

常用於法蘭和端蓋上的密封。其缺點是製造較困難，且供O形圈膨脹的空間非常小。

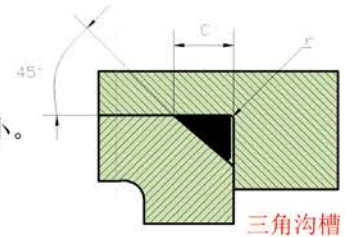

■表I三角溝槽安裝形式（單位：mm）

O 型圈界面直徑 W	邊長 K		半徑 r
1.78 1.80	2.40	+0.10	0.30
2.00	2.70	+0.10	0.40
2.40	3.20	+0.15	0.40
2.50	3.40	+0.15	0.60
2.62 2.60	3.50	+0.15	0.60
3.00	4.00	+0.20	0.60
3.10	4.10	+0.20	0.60
3.53 3.55	4.70	+0.20	0.90
4.00	5.40	+0.20	1.20
5.00	6.70	+0.25	1.20
5.33 5.30	7.10	+0.25	1.50
5.70	7.60	+0.30	1.50
6.00	8.00	+0.30	1.50
6.99 7.00	9.40	+0.30	2.00
8.00	10.80	+0.30	2.00
8.40	11.30	+0.30	2.00

b矩形溝槽

廣泛應用於各種場合。在不需要使用擋圈時，亦可做成傾斜側面（ $<5^\circ$ ）。

b矩形沟槽 (1)

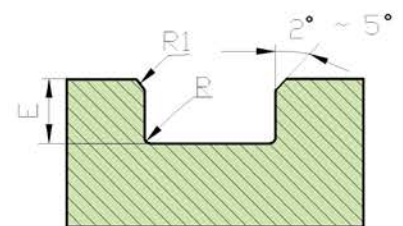

b矩形沟槽 (2)

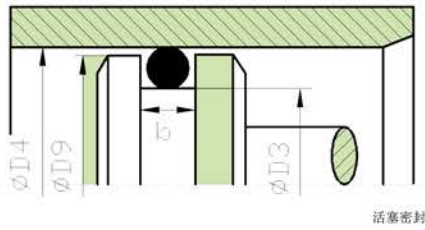

活塞密封

b矩形沟槽 (3)

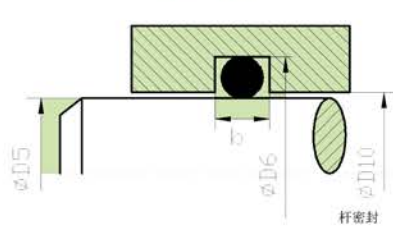

杆密封

b矩形沟槽 (4)

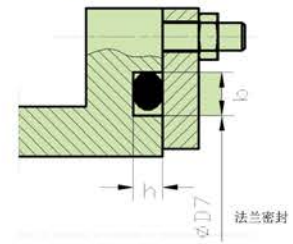

法兰密封

C梯形沟槽

僅推薦用於O形圈截面直徑大於2.5mm的某些特殊場合。例如為保持O形圈的頂部安裝，就可以考慮做成梯形溝槽形式。

C梯形沟槽

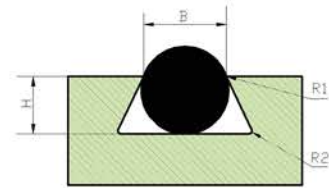

梯形溝槽安裝形式 (單位: mm)

O型圈截面直徑 W	溝槽尺寸			
	溝槽寬度	溝槽深度	半徑	
	B ± 0.05	H ± 0.05	R1	R2
2.50	2.05	2.00	0.25	0.40
2.62 2.65	2.15	2.10	0.25	0.40
3.00 3.10	2.40	2.40	0.25	0.40
3.53 3.55	2.90	2.90	0.25	0.80
4.00	3.10	3.20	0.25	0.80
5.00	3.90	4.20	0.25	0.80
5.33 5.30	4.10	4.60	0.40	0.80
5.70	4.40	4.80	0.40	0.80
6.00	4.60	5.10	0.40	0.80
6.99 7.00	5.60	6.00	0.40	1.60
8.00	6.00	6.90	0.40	1.60
8.40	6.30	7.30	0.40	1.60

五、O形圈的安裝

在進行O形圈安裝時，須注意以下事項

- ◇確保各稜邊或過渡孔處已倒角或倒鈍並去除毛刺。
- ◇檢查被密封表面有無缺陷。
- ◇清除所有的加工殘留物。
- ◇安裝路徑上的螺紋需加防護套，以防螺紋尖角刮傷O形圈。
- ◇為了方便安裝，可對O形圈安裝表面塗潤滑油脂。
- ◇手動安裝時，不可使用尖銳工具，但要盡量有效借助工具，以保證O形圈不扭曲。
- ◇禁止過分拉伸O形圈。
- ◇由密封帶製成的O形圈，禁止在其連接處進行拉伸。

六、貯存

密封件常作為備件方式貯存較長時間。為避免因外界因素而影響O形圈的物理和化學性能，使彈性體損壞，在貯存時應遵守以下一些規則：

- ◇貯存在乾燥處
- ◇溫度在+5℃~+25℃之間，避免和熱源直接接觸。
- ◇避免在陽光或氙光燈下直接照射。
- ◇置於原始裝箱或氣密容器內以防止氧化。
- ◇遠離有害氣源以防止彈性體受損。

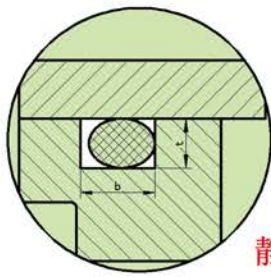

静态

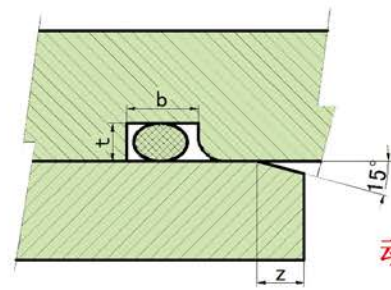

动态

O型圈/星型圈開槽尺寸建議參數 (靜態)

密封圈線徑 C/S	槽深 T	槽寬 B
1.00	0.80	1.30
1.50	1.10	1.90
1.60	1.20	2.10
1.78	1.30	2.30
1.90	1.40	2.40
2.00	1.50	2.60
2.40	1.80	3.10
2.50	1.90	3.20
2.62	2.00	3.40
2.70	2.10	3.50
3.00	2.30	3.90
3.50	2.70	4.50
3.53	2.70	4.50
3.60	2.80	4.70
4.00	3.15	5.20
4.50	3.60	5.80
5.00	4.00	6.50
5.33	4.30	6.90
5.50	4.50	7.10
5.70	4.65	7.40
6.00	4.95	7.80
6.50	5.40	8.40
6.99	5.85	9.10
7.00	5.85	9.10
7.50	6.30	9.70
8.00	6.75	10.40
8.40	7.15	10.90
8.50	7.25	11.00
9.00	7.70	11.70
9.50	8.20	12.30
10.00	8.65	13.00

O型圈/星型圈以液體作為介質時開槽尺寸建議參數 (動態)

密封圈線徑 C/S	槽深 T	槽寬 B	軸杆導角 Z
1.00	0.90	1.30	1.00
1.50	1.30	1.90	1.00
1.60	1.40	2.00	1.10
1.78	1.50	2.30	1.10
1.90	1.60	2.40	1.20
2.00	1.70	2.40	1.20
2.40	2.10	2.90	1.40
2.50	2.20	3.00	1.40
2.62	2.30	3.10	1.50
2.70	2.40	3.20	1.50
3.00	2.60	3.60	1.60
3.50	3.10	4.20	1.80
3.53	3.10	4.20	1.80
3.60	3.20	4.30	1.80
4.00	3.50	4.80	2.00
4.50	4.00	5.40	2.30
5.00	4.45	6.00	2.50
5.33	4.70	6.40	2.70
5.50	4.95	6.60	2.80
5.70	5.10	6.90	3.00
6.00	5.40	7.20	3.10
6.50	5.80	7.80	3.30
6.99	6.30	8.40	3.60
7.00	6.30	8.40	3.60
7.50	6.70	9.00	3.80
8.00	7.20	9.60	4.00
8.40	7.60	10.10	4.20
8.50	7.70	10.20	4.20
9.00	8.20	10.80	4.30
9.50	8.60	11.40	4.40
10.00	9.10	12.00	4.50

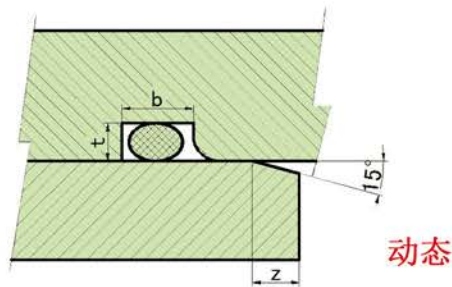

O型圈/星型圈以氣體作為介質時開槽尺寸建議參數（動態2）

密封圈線徑 C/S	槽深 T	槽寬 B	軸杆導角 Z
1.00	0.95	1.30	1.00
1.50	1.35	1.90	1.00
1.60	1.45	2.00	1.10
1.78	1.55	2.30	1.10
1.90	1.75	2.40	1.20
2.00	1.80	2.40	1.20
2.40	2.15	2.90	1.40
2.50	2.25	3.00	1.40
2.62	2.35	3.10	1.50
2.70	2.45	3.20	1.50
3.00	2.75	3.60	1.60
3.50	3.25	4.20	1.80
3.53	3.25	4.20	1.80
3.60	3.35	4.30	1.80
4.00	3.70	4.80	2.00
4.50	4.20	5.40	2.30
5.00	4.65	6.00	2.50
5.33	4.95	6.40	2.70
5.50	5.15	6.60	2.80
5.70	5.35	6.90	3.00
6.00	5.65	7.20	3.10
6.50	6.10	7.80	3.30
6.99	6.60	8.40	3.60
7.00	6.60	8.40	3.60
7.50	7.10	9.00	3.80
8.00	7.60	9.60	4.00
8.40	7.90	10.10	4.20
8.50	8.00	10.20	4.20
9.00	8.50	10.80	4.30
9.50	9.00	11.40	4.40
10.00	9.50	12.00	4.50

廠家：德國歐博斯

生產材料：材料物性表中所有膠種，包含聚氨酯，鐵氟龍材料

生產尺寸：內徑3000mm以下任何規格

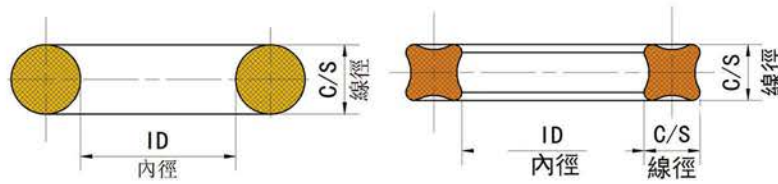

	ID	±	CS	±	ID	±	CS	±
A0001	0.029	0.004	0.04	0.003	0.74	0.1	1.02	0.08
A0002	0.042	0.004	0.05	0.003	1.07	0.1	1.27	0.08
A0003	0.056	0.004	0.06	0.003	1.42	0.1	1.52	0.08
A0004	0.07	0.005	0.07	0.003	1.78	0.13	1.78	0.08
A0005	0.101	0.005	0.07	0.003	2.57	0.13	1.78	0.08
A0006	0.114	0.005	0.07	0.003	2.9	0.13	1.78	0.08
A0007	0.145	0.005	0.07	0.003	3.68	0.13	1.78	0.08
A0008	0.176	0.005	0.07	0.003	4.47	0.13	1.78	0.08
A0009	0.208	0.005	0.07	0.003	5.28	0.13	1.78	0.08
A0010	0.239	0.005	0.07	0.003	6.07	0.13	1.78	0.08
A0011	0.301	0.005	0.07	0.003	7.65	0.13	1.78	0.08
A0012	0.364	0.005	0.07	0.003	9.25	0.13	1.78	0.08
A0013	0.426	0.005	0.07	0.003	10.82	0.13	1.78	0.08
A0014	0.489	0.005	0.07	0.003	12.42	0.13	1.78	0.08
A0015	0.551	0.007	0.07	0.003	14	0.18	1.78	0.08
A0016	0.614	0.009	0.07	0.003	15.6	0.23	1.78	0.08
A0017	0.676	0.009	0.07	0.003	17.17	0.23	1.78	0.08
A0018	0.739	0.009	0.07	0.003	18.77	0.23	1.78	0.08
A0019	0.801	0.009	0.07	0.003	20.35	0.23	1.78	0.08
A0020	0.864	0.009	0.07	0.003	21.95	0.23	1.78	0.08
A0021	0.926	0.009	0.07	0.003	23.52	0.23	1.78	0.08
A0022	0.989	0.01	0.07	0.003	25.12	0.25	1.78	0.08
A0023	1.051	0.01	0.07	0.003	26.7	0.25	1.78	0.08
A0024	1.114	0.01	0.07	0.003	28.3	0.25	1.78	0.08
A0025	1.176	0.011	0.07	0.003	29.87	0.28	1.78	0.08
A0026	1.239	0.011	0.07	0.003	31.47	0.28	1.78	0.08
A0027	1.301	0.011	0.07	0.003	33.05	0.28	1.78	0.08
A0028	1.364	0.013	0.07	0.003	34.65	0.33	1.78	0.08
A0029	1.489	0.013	0.07	0.003	37.82	0.33	1.78	0.08
A0030	1.614	0.013	0.07	0.003	41	0.33	1.78	0.08
A0031	1.739	0.015	0.07	0.003	44.17	0.38	1.78	0.08
A0032	1.864	0.015	0.07	0.003	47.35	0.38	1.78	0.08
A0033	1.989	0.018	0.07	0.003	50.52	0.46	1.78	0.08
A0034	2.114	0.018	0.07	0.003	53.7	0.46	1.78	0.08
A0035	2.239	0.018	0.07	0.003	56.87	0.46	1.78	0.08
A0036	2.364	0.018	0.07	0.003	60.05	0.46	1.78	0.08

廠家：德國歐博斯

生產材料：材料物性表中所有膠種，包含聚氨酯，鐵氟龍材料

生產尺寸：內徑3000mm以下任何規格

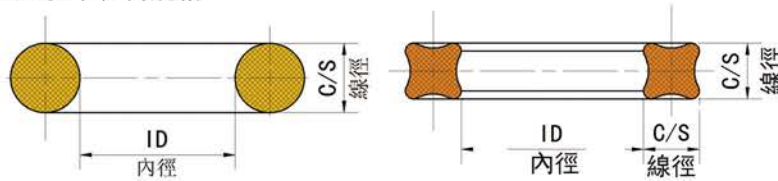

As568	ID	±	CS	±	ID	±	CS	±
A0037	2.489	0.018	0.07	0.003	63.22	0.46	1.78	0.08
A0038	2.614	0.02	0.07	0.003	66.4	0.51	1.78	0.08
A0039	2.739	0.02	0.07	0.003	69.57	0.51	1.78	0.08
A0040	2.864	0.02	0.07	0.003	72.75	0.51	1.78	0.08
A0041	2.989	0.024	0.07	0.003	75.92	0.61	1.78	0.08
A0042	3.239	0.024	0.07	0.003	82.27	0.61	1.78	0.08
A0043	3.489	0.024	0.07	0.003	88.62	0.61	1.78	0.08
A0044	3.739	0.027	0.07	0.003	94.97	0.69	1.78	0.08
A0045	3.989	0.027	0.07	0.003	101.32	0.69	1.78	0.08
A0046	4.239	0.03	0.07	0.003	107.67	0.76	1.78	0.08
A0047	4.489	0.03	0.07	0.003	114.02	0.76	1.78	0.08
A0048	4.739	0.03	0.07	0.003	120.37	0.76	1.78	0.08
A0049	4.989	0.037	0.07	0.003	126.72	0.94	1.78	0.08
A0050	5.239	0.037	0.07	0.003	133.07	0.94	1.78	0.08
A0102	0.049	0.005	0.103	0.003	1.24	0.13	2.62	0.08
A0103	0.081	0.005	0.103	0.003	2.06	0.13	2.62	0.08
A0104	0.112	0.005	0.103	0.003	2.84	0.13	2.62	0.08
A0105	0.143	0.005	0.103	0.003	3.63	0.13	2.62	0.08
A0106	0.174	0.005	0.103	0.003	4.42	0.13	2.62	0.08
A0107	0.206	0.005	0.103	0.003	5.23	0.13	2.62	0.08
A0108	0.237	0.005	0.103	0.003	6.02	0.13	2.62	0.08
A0109	0.299	0.005	0.103	0.003	7.59	0.13	2.62	0.08
A0110	0.362	0.005	0.103	0.003	9.19	0.13	2.62	0.08
A0111	0.424	0.005	0.103	0.003	10.77	0.13	2.62	0.08
A0112	0.487	0.005	0.103	0.003	12.37	0.13	2.62	0.08
A0113	0.549	0.007	0.103	0.003	13.94	0.18	2.62	0.08
A0114	0.612	0.009	0.103	0.003	15.54	0.23	2.62	0.08
A0115	0.674	0.009	0.103	0.003	17.12	0.23	2.62	0.08
A0116	0.737	0.009	0.103	0.003	18.72	0.23	2.62	0.08
A0117	0.799	0.01	0.103	0.003	20.29	0.25	2.62	0.08
A0118	0.862	0.01	0.103	0.003	21.89	0.25	2.62	0.08
A0119	0.924	0.01	0.103	0.003	23.47	0.25	2.62	0.08
A0120	0.987	0.01	0.103	0.003	25.07	0.25	2.62	0.08
A0121	1.049	0.01	0.103	0.003	26.64	0.25	2.62	0.08
A0122	1.112	0.01	0.103	0.003	28.24	0.25	2.62	0.08

廠家：德國歐博斯

生產材料：材料物性表中所有膠種，包含聚氨酯，鐵氟龍材料

生產尺寸：內徑3000mm以下任何規格

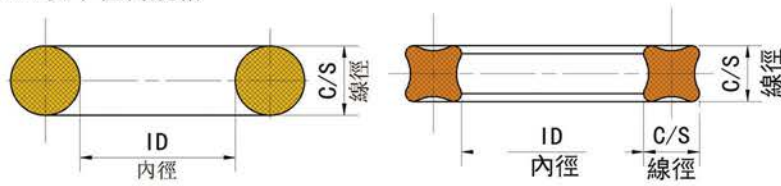

As568	ID	±	CS	±	ID	±	CS	±
A0123	1.174	0.012	0.103	0.003	29.82	0.3	2.62	0.08
A0124	1.237	0.012	0.103	0.003	31.42	0.3	2.62	0.08
A0125	1.299	0.012	0.103	0.003	32.99	0.3	2.62	0.08
A0126	1.362	0.012	0.103	0.003	34.59	0.3	2.62	0.08
A0127	1.424	0.012	0.103	0.003	36.17	0.3	2.62	0.08
A0128	1.487	0.012	0.103	0.003	37.77	0.3	2.62	0.08
A0129	1.549	0.015	0.103	0.003	39.34	0.38	2.62	0.08
A0130	1.612	0.015	0.103	0.003	40.94	0.38	2.62	0.08
A0131	1.674	0.015	0.103	0.003	42.52	0.38	2.62	0.08
A0132	1.737	0.015	0.103	0.003	44.12	0.38	2.62	0.08
A0133	1.799	0.015	0.103	0.003	45.69	0.38	2.62	0.08
A0134	1.862	0.015	0.103	0.003	47.29	0.38	2.62	0.08
A0135	1.925	0.017	0.103	0.003	48.9	0.43	2.62	0.08
A0136	1.987	0.017	0.103	0.003	50.47	0.43	2.62	0.08
A0137	2.05	0.017	0.103	0.003	52.07	0.43	2.62	0.08
A0138	2.112	0.017	0.103	0.003	53.64	0.43	2.62	0.08
A0139	2.175	0.017	0.103	0.003	55.25	0.43	2.62	0.08
A0140	2.237	0.017	0.103	0.003	56.82	0.43	2.62	0.08
A0141	2.3	0.02	0.103	0.003	58.42	0.51	2.62	0.08
A0142	2.362	0.02	0.103	0.003	59.99	0.51	2.62	0.08
A0143	2.425	0.02	0.103	0.003	61.6	0.51	2.62	0.08
A0144	2.487	0.02	0.103	0.003	63.17	0.51	2.62	0.08
A0145	2.55	0.02	0.103	0.003	64.77	0.51	2.62	0.08
A0146	2.612	0.02	0.103	0.003	66.34	0.51	2.62	0.08
A0147	2.675	0.022	0.103	0.003	67.95	0.56	2.62	0.08
A0148	2.737	0.022	0.103	0.003	69.52	0.56	2.62	0.08
A0149	2.8	0.022	0.103	0.003	71.12	0.56	2.62	0.08
A0150	2.862	0.022	0.103	0.003	72.69	0.56	2.62	0.08
A0151	2.987	0.024	0.103	0.003	75.87	0.61	2.62	0.08
A0152	3.237	0.024	0.103	0.003	82.22	0.61	2.62	0.08
A0153	3.487	0.024	0.103	0.003	88.57	0.61	2.62	0.08
A0154	3.737	0.028	0.103	0.003	94.92	0.71	2.62	0.08
A0155	3.987	0.028	0.103	0.003	101.27	0.71	2.62	0.08
A0156	4.237	0.03	0.103	0.003	107.62	0.76	2.62	0.08
A0157	4.487	0.03	0.103	0.003	113.97	0.76	2.62	0.08

廠家：德國歐博斯

生產材料：材料物性表中所有膠種，包含聚氨酯，鐵氟龍材料

生產尺寸：內徑3000mm以下任何規格

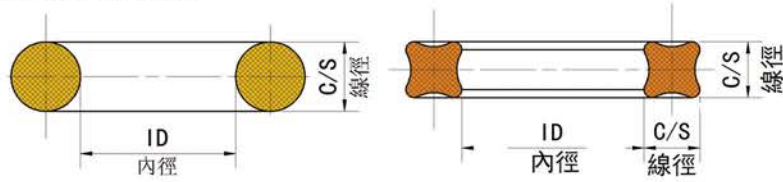

As568	ID	±	CS	±	ID	±	CS	±
A0158	4.737	0.03	0.103	0.003	120.32	0.76	2.62	0.08
A0159	4.987	0.035	0.103	0.003	126.67	0.89	2.62	0.08
A0160	5.237	0.035	0.103	0.003	133.02	0.89	2.62	0.08
A0161	5.487	0.035	0.103	0.003	139.37	0.89	2.62	0.08
A0162	5.737	0.035	0.103	0.003	145.72	0.89	2.62	0.08
A0163	5.987	0.035	0.103	0.003	152.07	0.89	2.62	0.08
A0164	6.237	0.04	0.103	0.003	158.42	1.02	2.62	0.08
A0165	6.487	0.04	0.103	0.003	164.77	1.02	2.62	0.08
A0166	6.737	0.04	0.103	0.003	171.12	1.02	2.62	0.08
A0167	6.987	0.04	0.103	0.003	177.47	1.02	2.62	0.08
A0168	7.237	0.045	0.103	0.003	183.82	1.14	2.62	0.08
A0169	7.487	0.045	0.103	0.003	190.17	1.14	2.62	0.08
A0170	7.737	0.045	0.103	0.003	196.52	1.14	2.62	0.08
A0171	7.987	0.045	0.103	0.003	202.87	1.14	2.62	0.08
A0172	8.237	0.05	0.103	0.003	209.22	1.27	2.62	0.08
A0173	8.487	0.05	0.103	0.003	215.57	1.27	2.62	0.08
A0174	8.737	0.05	0.103	0.003	221.92	1.27	2.62	0.08
A0175	8.987	0.05	0.103	0.003	228.27	1.27	2.62	0.08
A0176	9.237	0.055	0.103	0.003	234.62	1.4	2.62	0.08
A0177	9.487	0.055	0.103	0.003	240.97	1.4	2.62	0.08
A0178	9.737	0.055	0.103	0.003	247.32	1.4	2.62	0.08
A0201	0.171	0.005	0.139	0.004	4.34	0.13	3.53	0.1
A0202	0.234	0.005	0.139	0.004	5.94	0.13	3.53	0.1
A0203	0.296	0.005	0.139	0.004	7.52	0.13	3.53	0.1
A0204	0.359	0.005	0.139	0.004	9.12	0.13	3.53	0.1
A0205	0.421	0.005	0.139	0.004	10.69	0.13	3.53	0.1
A0206	0.484	0.005	0.139	0.004	12.29	0.13	3.53	0.1
A0207	0.546	0.007	0.139	0.004	13.87	0.18	3.53	0.1
A0208	0.609	0.009	0.139	0.004	15.47	0.23	3.53	0.1
A0209	0.671	0.009	0.139	0.004	17.04	0.23	3.53	0.1
A0210	0.734	0.01	0.139	0.004	18.64	0.25	3.53	0.1
A0211	0.796	0.01	0.139	0.004	20.22	0.25	3.53	0.1
A0212	0.859	0.01	0.139	0.004	21.82	0.25	3.53	0.1
A0213	0.921	0.01	0.139	0.004	23.39	0.25	3.53	0.1
A0214	0.984	0.01	0.139	0.004	24.99	0.25	3.53	0.1

廠家：德國歐博斯

生產材料：材料物性表中所有膠種，包含聚氨酯，鐵氟龍材料

生產尺寸：內徑3000mm以下任何規格

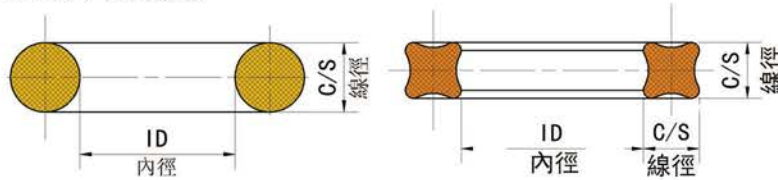

As568	ID	±	CS	±	ID	±	CS	±
A0215	1.046	0.01	0.139	0.004	26.57	0.25	3.53	0.1
A0216	1.109	0.012	0.139	0.004	28.17	0.3	3.53	0.1
A0217	1.171	0.012	0.139	0.004	29.74	0.3	3.53	0.1
A0218	1.234	0.012	0.139	0.004	31.34	0.3	3.53	0.1
A0219	1.296	0.012	0.139	0.004	32.92	0.3	3.53	0.1
A0220	1.359	0.012	0.139	0.004	34.52	0.3	3.53	0.1
A0221	1.421	0.012	0.139	0.004	36.09	0.3	3.53	0.1
A0222	1.484	0.015	0.139	0.004	37.69	0.38	3.53	0.1
A0223	1.609	0.015	0.139	0.004	40.87	0.38	3.53	0.1
A0224	1.734	0.015	0.139	0.004	44.04	0.38	3.53	0.1
A0225	1.859	0.018	0.139	0.004	47.22	0.46	3.53	0.1
A0226	1.984	0.018	0.139	0.004	50.39	0.46	3.53	0.1
A0227	2.109	0.018	0.139	0.004	53.57	0.46	3.53	0.1
A0228	2.234	0.02	0.139	0.004	56.74	0.51	3.53	0.1
A0229	2.359	0.02	0.139	0.004	59.92	0.51	3.53	0.1
A0230	2.484	0.02	0.139	0.004	63.09	0.51	3.53	0.1
A0231	2.609	0.02	0.139	0.004	66.27	0.51	3.53	0.1
A0232	2.734	0.024	0.139	0.004	69.44	0.61	3.53	0.1
A0233	2.859	0.024	0.139	0.004	72.62	0.61	3.53	0.1
A0234	2.984	0.024	0.139	0.004	75.79	0.61	3.53	0.1
A0235	3.109	0.024	0.139	0.004	78.97	0.61	3.53	0.1
A0236	3.234	0.024	0.139	0.004	82.14	0.61	3.53	0.1
A0237	3.359	0.024	0.139	0.004	85.32	0.61	3.53	0.1
A0238	3.484	0.024	0.139	0.004	88.49	0.61	3.53	0.1
A0239	3.609	0.028	0.139	0.004	91.67	0.71	3.53	0.1
A0240	3.734	0.028	0.139	0.004	94.84	0.71	3.53	0.1
A0241	3.859	0.028	0.139	0.004	98.02	0.71	3.53	0.1
A0242	3.984	0.028	0.139	0.004	101.19	0.71	3.53	0.1
A0243	4.109	0.028	0.139	0.004	104.37	0.71	3.53	0.1
A0244	4.234	0.03	0.139	0.004	107.54	0.76	3.53	0.1
A0245	4.359	0.03	0.139	0.004	110.72	0.76	3.53	0.1
A0246	4.484	0.03	0.139	0.004	113.89	0.76	3.53	0.1
A0247	4.609	0.03	0.139	0.004	117.07	0.76	3.53	0.1
A0248	4.734	0.03	0.139	0.004	120.24	0.76	3.53	0.1
A0249	4.859	0.035	0.139	0.004	123.42	0.89	3.53	0.1

廠家：德國歐博斯

生產材料：材料物性表中所有膠種，包含聚氨酯，鐵氟龍材料

生產尺寸：內徑3000mm以下任何規格

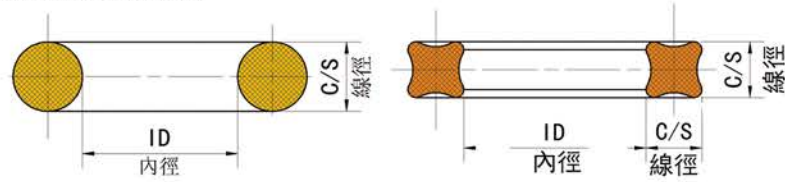

As568	ID	±	CS	±	ID	±	CS	±
A0250	4.984	0.035	0.139	0.004	126.59	0.89	3.53	0.1
A0251	5.109	0.035	0.139	0.004	129.77	0.89	3.53	0.1
A0252	5.234	0.035	0.139	0.004	132.94	0.89	3.53	0.1
A0253	5.359	0.035	0.139	0.004	136.12	0.89	3.53	0.1
A0254	5.484	0.035	0.139	0.004	139.29	0.89	3.53	0.1
A0255	5.609	0.035	0.139	0.004	142.47	0.89	3.53	0.1
A0256	5.734	0.035	0.139	0.004	145.64	0.89	3.53	0.1
A0257	5.859	0.035	0.139	0.004	148.82	0.89	3.53	0.1
A0258	5.984	0.035	0.139	0.004	151.99	0.89	3.53	0.1
A0259	6.234	0.04	0.139	0.004	158.34	1.02	3.53	0.1
A0260	6.484	0.04	0.139	0.004	164.69	1.02	3.53	0.1
A0261	6.734	0.04	0.139	0.004	171.04	1.02	3.53	0.1
A0262	6.984	0.04	0.139	0.004	177.39	1.02	3.53	0.1
A0263	7.234	0.045	0.139	0.004	183.74	1.14	3.53	0.1
A0264	7.484	0.045	0.139	0.004	190.09	1.14	3.53	0.1
A0265	7.734	0.045	0.139	0.004	196.44	1.14	3.53	0.1
A0266	7.984	0.045	0.139	0.004	202.79	1.14	3.53	0.1
A0267	8.234	0.05	0.139	0.004	209.14	1.27	3.53	0.1
A0268	8.484	0.05	0.139	0.004	215.49	1.27	3.53	0.1
A0269	8.734	0.05	0.139	0.004	221.84	1.27	3.53	0.1
A0270	8.984	0.05	0.139	0.004	228.19	1.27	3.53	0.1
A0271	9.234	0.055	0.139	0.004	234.54	1.4	3.53	0.1
A0272	9.484	0.055	0.139	0.004	240.89	1.4	3.53	0.1
A0273	9.734	0.055	0.139	0.004	247.24	1.4	3.53	0.1
A0274	9.984	0.055	0.139	0.004	253.59	1.4	3.53	0.1
A0275	10.484	0.055	0.139	0.004	266.29	1.4	3.53	0.1
A0276	10.984	0.065	0.139	0.004	278.99	1.65	3.53	0.1
A0277	11.484	0.065	0.139	0.004	291.69	1.65	3.53	0.1
A0278	11.984	0.065	0.139	0.004	304.39	1.65	3.53	0.1
A0279	12.984	0.065	0.139	0.004	329.79	1.65	3.53	0.1
A0280	13.984	0.065	0.139	0.004	355.19	1.65	3.53	0.1
A0281	14.984	0.065	0.139	0.004	380.59	1.65	3.53	0.1
A0282	15.955	0.075	0.139	0.004	405.26	1.91	3.53	0.1
A0283	16.955	0.08	0.139	0.004	430.66	2.03	3.53	0.1
A0284	17.955	0.085	0.139	0.004	456.06	2.16	3.53	0.1

廠家：德國歐博斯

生產材料：材料物性表中所有膠種，包含聚氨酯，鐵氟龍材料

生產尺寸：內徑3000mm以下任何規格

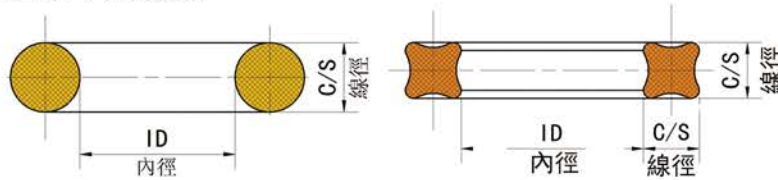

As568	ID	±	CS	±	ID	±	CS	±
A0309	0.412	0.005	0.21	0.005	10.46	0.13	5.33	0.13
A0310	0.475	0.005	0.21	0.005	12.07	0.13	5.33	0.13
A0311	0.537	0.007	0.21	0.005	13.64	0.18	5.33	0.13
A0312	0.6	0.009	0.21	0.005	15.24	0.23	5.33	0.13
A0313	0.662	0.009	0.21	0.005	16.81	0.23	5.33	0.13
A0314	0.725	0.01	0.21	0.005	18.42	0.25	5.33	0.13
A0315	0.787	0.01	0.21	0.005	19.99	0.25	5.33	0.13
A0316	0.85	0.01	0.21	0.005	21.59	0.25	5.33	0.13
A0317	0.912	0.01	0.21	0.005	23.16	0.25	5.33	0.13
A0318	0.975	0.01	0.21	0.005	24.77	0.25	5.33	0.13
A0319	1.037	0.01	0.21	0.005	26.34	0.25	5.33	0.13
A0320	1.1	0.012	0.21	0.005	27.94	0.3	5.33	0.13
A0321	1.162	0.012	0.21	0.005	29.51	0.3	5.33	0.13
A0322	1.225	0.012	0.21	0.005	31.12	0.3	5.33	0.13
A0323	1.287	0.012	0.21	0.005	32.69	0.3	5.33	0.13
A0324	1.35	0.012	0.21	0.005	34.29	0.3	5.33	0.13
A0325	1.475	0.015	0.21	0.005	37.47	0.38	5.33	0.13
A0326	1.6	0.015	0.21	0.005	40.64	0.38	5.33	0.13
A0327	1.725	0.015	0.21	0.005	43.82	0.38	5.33	0.13
A0328	1.85	0.015	0.21	0.005	46.99	0.38	5.33	0.13
A0329	1.975	0.018	0.21	0.005	50.17	0.46	5.33	0.13
A0330	2.1	0.018	0.21	0.005	53.34	0.46	5.33	0.13
A0331	2.225	0.018	0.21	0.005	56.52	0.46	5.33	0.13
A0332	2.35	0.018	0.21	0.005	59.69	0.46	5.33	0.13
A0333	2.475	0.02	0.21	0.005	62.87	0.51	5.33	0.13
A0334	2.6	0.02	0.21	0.005	66.04	0.51	5.33	0.13
A0335	2.725	0.02	0.21	0.005	69.22	0.51	5.33	0.13
A0336	2.85	0.02	0.21	0.005	72.39	0.51	5.33	0.13
A0337	2.975	0.024	0.21	0.005	75.57	0.61	5.33	0.13
A0338	3.1	0.024	0.21	0.005	78.74	0.61	5.33	0.13
A0339	3.225	0.024	0.21	0.005	81.92	0.61	5.33	0.13
A0340	3.35	0.024	0.21	0.005	85.09	0.61	5.33	0.13
A0341	3.475	0.024	0.21	0.005	88.27	0.61	5.33	0.13
A0342	3.6	0.028	0.21	0.005	91.44	0.71	5.33	0.13
A0343	3.725	0.028	0.21	0.005	94.62	0.71	5.33	0.13

廠家：德國歐博斯

生產材料：材料物性表中所有膠種，包含聚氨酯，鐵氟龍材料

生產尺寸：內徑3000mm以下任何規格

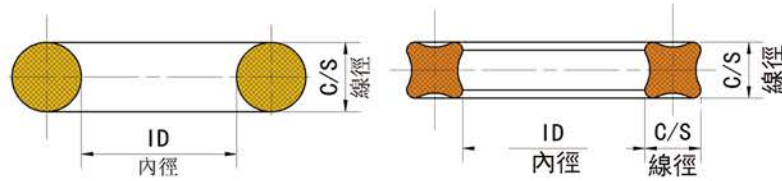

	ID	±	CS	±	ID	±	CS	±
A0344	3.85	0.028	0.21	0.005	97.79	0.71	5.33	0.13
A0345	3.975	0.028	0.21	0.005	100.97	0.71	5.33	0.13
A0346	4.1	0.028	0.21	0.005	104.14	0.71	5.33	0.13
A0347	4.225	0.03	0.21	0.005	107.32	0.76	5.33	0.13
A0348	4.35	0.03	0.21	0.005	110.49	0.76	5.33	0.13
A0349	4.475	0.03	0.21	0.005	113.67	0.76	5.33	0.13
A0350	4.6	0.03	0.21	0.005	116.84	0.76	5.33	0.13
A0351	4.725	0.03	0.21	0.005	120.02	0.76	5.33	0.13
A0352	4.85	0.03	0.21	0.005	123.19	0.76	5.33	0.13
A0353	4.975	0.037	0.21	0.005	126.37	0.94	5.33	0.13
A0354	5.1	0.037	0.21	0.005	129.54	0.94	5.33	0.13
A0355	5.225	0.037	0.21	0.005	132.72	0.94	5.33	0.13
A0356	5.35	0.037	0.21	0.005	135.89	0.94	5.33	0.13
A0357	5.475	0.037	0.21	0.005	139.07	0.94	5.33	0.13
A0358	5.6	0.037	0.21	0.005	142.24	0.94	5.33	0.13
A0359	5.725	0.037	0.21	0.005	145.42	0.94	5.33	0.13
A0360	5.85	0.037	0.21	0.005	148.59	0.94	5.33	0.13
A0361	5.975	0.037	0.21	0.005	151.77	0.94	5.33	0.13
A0362	6.225	0.04	0.21	0.005	158.12	1.02	5.33	0.13
A0363	6.475	0.04	0.21	0.005	164.47	1.02	5.33	0.13
A0364	6.725	0.04	0.21	0.005	170.82	1.02	5.33	0.13
A0365	6.975	0.04	0.21	0.005	177.17	1.02	5.33	0.13
A0366	7.225	0.045	0.21	0.005	183.52	1.14	5.33	0.13
A0367	7.475	0.045	0.21	0.005	189.87	1.14	5.33	0.13
A0368	7.725	0.045	0.21	0.005	196.22	1.14	5.33	0.13
A0369	7.975	0.045	0.21	0.005	202.57	1.14	5.33	0.13
A0370	8.225	0.05	0.21	0.005	208.92	1.27	5.33	0.13
A0371	8.475	0.05	0.21	0.005	215.27	1.27	5.33	0.13
A0372	8.725	0.05	0.21	0.005	221.62	1.27	5.33	0.13
A0373	8.975	0.05	0.21	0.005	227.97	1.27	5.33	0.13
A0374	9.225	0.055	0.21	0.005	234.32	1.4	5.33	0.13
A0375	9.475	0.055	0.21	0.005	240.67	1.4	5.33	0.13
A0376	9.725	0.055	0.21	0.005	247.02	1.4	5.33	0.13
A0377	9.975	0.055	0.21	0.005	253.37	1.4	5.33	0.13
A0378	10.475	0.06	0.21	0.005	266.07	1.52	5.33	0.13

廠家：德國歐博斯

生產材料：材料物性表中所有膠種，包含聚氨酯，鐵氟龍材料

生產尺寸：內徑3000mm以下任何規格

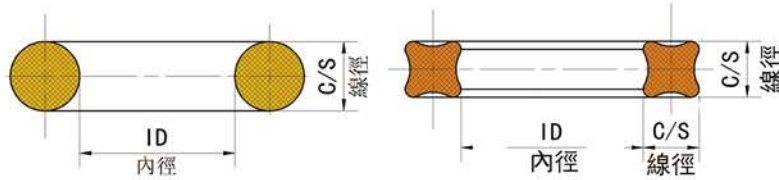

	ID	±	CS	±	ID	±	CS	±
A0379	10.975	0.06	0.21	0.005	278.77	1.52	5.33	0.13
A0380	11.475	0.065	0.21	0.005	291.47	1.65	5.33	0.13
A0381	11.975	0.065	0.21	0.005	304.17	1.65	5.33	0.13
A0382	12.975	0.065	0.21	0.005	329.57	1.65	5.33	0.13
A0383	13.975	0.07	0.21	0.005	354.97	1.78	5.33	0.13
A0384	14.975	0.07	0.21	0.005	380.37	1.78	5.33	0.13
A0385	15.955	0.075	0.21	0.005	405.26	1.91	5.33	0.13
A0386	16.955	0.08	0.21	0.005	430.66	2.03	5.33	0.13
A0387	17.955	0.085	0.21	0.005	456.06	2.16	5.33	0.13
A0388	18.955	0.09	0.21	0.005	481.46	2.29	5.33	0.13
A0389	19.955	0.095	0.21	0.005	506.86	2.41	5.33	0.13
A0390	20.955	0.095	0.21	0.005	532.26	2.41	5.33	0.13
A0391	21.955	0.1	0.21	0.005	557.66	2.54	5.33	0.13
A0392	22.94	0.105	0.21	0.005	582.68	2.67	5.33	0.13
A0393	23.94	0.11	0.21	0.005	608.08	2.79	5.33	0.13
A0394	24.94	0.115	0.21	0.005	633.48	2.92	5.33	0.13
A0395	25.94	0.12	0.21	0.005	658.88	3.05	5.33	0.13
A0400	1.35	0.013	0.275	0.006	34.29	0.33	6.99	0.15
A0401	1.475	0.014	0.275	0.006	37.47	0.36	6.99	0.15
A0402	1.6	0.015	0.275	0.006	40.64	0.39	6.99	0.15
A0403	1.725	0.016	0.275	0.006	43.82	0.41	6.99	0.15
A0404	1.85	0.017	0.275	0.006	46.99	0.44	6.99	0.15
A0405	1.975	0.018	0.275	0.006	50.17	0.46	6.99	0.15
A0406	2.1	0.019	0.275	0.006	53.34	0.48	6.99	0.15
A0407	2.225	0.02	0.275	0.006	56.52	0.51	6.99	0.15
A0408	2.35	0.021	0.275	0.006	59.69	0.54	6.99	0.15
A0409	2.475	0.022	0.275	0.006	62.87	0.56	6.99	0.15
A0410	2.6	0.023	0.275	0.006	66.04	0.59	6.99	0.15
A0411	2.725	0.024	0.275	0.006	69.22	0.61	6.99	0.15
A0412	2.85	0.025	0.275	0.006	72.39	0.64	6.99	0.15
A0413	2.975	0.026	0.275	0.006	75.57	0.66	6.99	0.15
A0414	3.1	0.026	0.275	0.006	78.74	0.67	6.99	0.15
A0415	3.225	0.028	0.275	0.006	81.92	0.71	6.99	0.15
A0416	3.35	0.029	0.275	0.006	85.09	0.73	6.99	0.15
A0417	3.475	0.03	0.275	0.006	88.27	0.75	6.99	0.15

廠家：德國歐博斯

生產材料：材料物性表中所有膠種，包含聚氨酯，鐵氟龍材料

生產尺寸：內徑3000mm以下任何規格

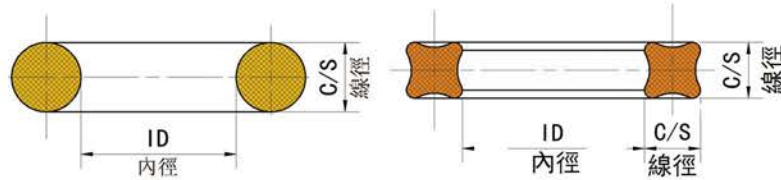

As568	ID	±	CS	±	ID	±	CS	±
A0418	3.6	0.031	0.275	0.006	91.44	0.79	6.99	0.15
A0419	3.725	0.032	0.275	0.006	94.62	0.81	6.99	0.15
A0420	3.85	0.033	0.275	0.006	97.79	0.83	6.99	0.15
A0421	3.975	0.033	0.275	0.006	100.97	0.84	6.99	0.15
A0422	4.1	0.034	0.275	0.006	104.14	0.87	6.99	0.15
A0423	4.225	0.035	0.275	0.006	107.32	0.89	6.99	0.15
A0424	4.35	0.036	0.275	0.006	110.49	0.91	6.99	0.15
A0425	4.475	0.033	0.275	0.006	113.67	0.84	6.99	0.15
A0426	4.6	0.033	0.275	0.006	116.84	0.84	6.99	0.15
A0427	4.725	0.033	0.28	0.006	120.02	0.84	6.99	0.15
A0428	4.85	0.033	0.28	0.006	123.19	0.84	6.99	0.15
A0429	4.975	0.037	0.275	0.006	126.37	0.94	6.99	0.15
A0430	5.1	0.037	0.275	0.006	129.54	0.94	6.99	0.15
A0431	5.225	0.037	0.275	0.006	132.72	0.94	6.99	0.15
A0432	5.35	0.037	0.275	0.006	135.89	0.94	6.99	0.15
A0433	5.475	0.037	0.275	0.006	139.07	0.94	6.99	0.15
A0434	5.6	0.037	0.275	0.006	142.24	0.94	6.99	0.15
A0435	5.725	0.037	0.275	0.006	145.42	0.94	6.99	0.15
A0436	5.85	0.037	0.275	0.006	148.59	0.94	6.99	0.15
A0437	5.975	0.037	0.275	0.006	151.77	0.94	6.99	0.15
A0438	6.225	0.04	0.275	0.006	158.12	1.02	6.99	0.15
A0439	6.475	0.04	0.275	0.006	164.47	1.02	6.99	0.15
A0440	6.725	0.04	0.275	0.006	170.82	1.02	6.99	0.15
A0441	6.975	0.04	0.275	0.006	177.17	1.02	6.99	0.15
A0442	7.225	0.045	0.275	0.006	183.52	1.14	6.99	0.15
A0443	7.475	0.045	0.275	0.006	189.87	1.14	6.99	0.15
A0444	7.725	0.045	0.275	0.006	196.22	1.14	6.99	0.15
A0445	7.975	0.045	0.275	0.006	202.57	1.14	6.99	0.15
A0446	8.475	0.055	0.275	0.006	215.27	1.4	6.99	0.15
A0447	8.975	0.055	0.275	0.006	227.97	1.4	6.99	0.15
A0448	9.475	0.055	0.275	0.006	240.67	1.4	6.99	0.15
A0449	9.975	0.055	0.275	0.006	253.37	1.4	6.99	0.15
A0450	10.475	0.06	0.275	0.006	266.07	1.52	6.99	0.15
A0451	10.975	0.06	0.275	0.006	278.77	1.52	6.99	0.15
A0452	11.475	0.06	0.275	0.006	291.47	1.52	6.99	0.15

廠家：德國歐博斯

生產材料：材料物性表中所有膠種，包含聚氨酯，鐵氟龍材料

生產尺寸：內徑3000mm以下任何規格

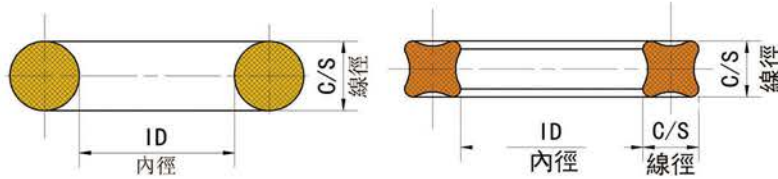

	ID	±	CS	±	ID	±	CS	±
A0453	11.975	0.06	0.275	0.006	304.17	1.52	6.99	0.15
A0454	12.475	0.06	0.275	0.006	316.87	1.52	6.99	0.15
A0455	12.975	0.06	0.275	0.006	329.57	1.52	6.99	0.15
A0456	13.475	0.07	0.275	0.006	342.27	1.78	6.99	0.15
A0457	13.975	0.07	0.275	0.006	354.97	1.78	6.99	0.15
A0458	14.475	0.07	0.275	0.006	367.67	1.78	6.99	0.15
A0459	14.975	0.07	0.275	0.006	380.37	1.78	6.99	0.15
A0460	15.475	0.07	0.275	0.006	393.07	1.78	6.99	0.15
A0461	15.955	0.075	0.275	0.006	405.26	1.91	6.99	0.15
A0462	16.455	0.075	0.275	0.006	417.96	1.91	6.99	0.15
A0463	16.955	0.08	0.275	0.006	430.66	2.03	6.99	0.15
A0464	17.455	0.085	0.275	0.006	443.36	2.16	6.99	0.15
A0465	17.955	0.085	0.275	0.006	456.06	2.16	6.99	0.15
A0466	18.455	0.085	0.275	0.006	468.76	2.16	6.99	0.15
A0467	18.955	0.09	0.275	0.006	481.46	2.29	6.99	0.15
A0468	19.455	0.09	0.275	0.006	494.16	2.29	6.99	0.15
A0469	19.955	0.095	0.275	0.006	506.86	2.41	6.99	0.15
A0470	20.955	0.095	0.275	0.006	532.26	2.41	6.99	0.15
A0471	21.955	0.1	0.275	0.006	557.66	2.54	6.99	0.15
A0472	22.94	0.105	0.275	0.006	582.68	2.67	6.99	0.15
A0473	23.94	0.11	0.275	0.006	608.08	2.79	6.99	0.15
A0474	24.94	0.115	0.275	0.006	633.48	2.92	6.99	0.15
A0475	25.94	0.12	0.275	0.006	658.88	3.05	6.99	0.15
A0901	0.185	0.005	0.056	0.003	4.7	0.13	1.42	0.08
A0902	0.239	0.005	0.064	0.003	6.07	0.13	1.63	0.08
A0903	0.301	0.005	0.064	0.003	7.65	0.13	1.63	0.08
A0904	0.351	0.005	0.072	0.003	8.92	0.13	1.83	0.08
A0905	0.414	0.005	0.072	0.003	10.52	0.13	1.83	0.08
A0906	0.468	0.005	0.078	0.003	11.89	0.13	1.98	0.08
A0907	0.53	0.007	0.082	0.003	13.46	0.18	2.08	0.08
A0908	0.644	0.009	0.087	0.003	16.36	0.23	2.21	0.08
A0909	0.706	0.009	0.097	0.003	17.93	0.23	2.46	0.08
A0910	0.755	0.009	0.097	0.003	19.18	0.23	2.46	0.08
A0911	0.863	0.009	0.116	0.004	21.92	0.23	2.95	0.1
A0912	0.924	0.009	0.116	0.004	23.47	0.23	2.95	0.1

廠家：德國歐博斯

生產材料：材料物性表中所有膠種，包含聚氨酯，鐵氟龍材料

生產尺寸：內徑3000mm以下任何規格

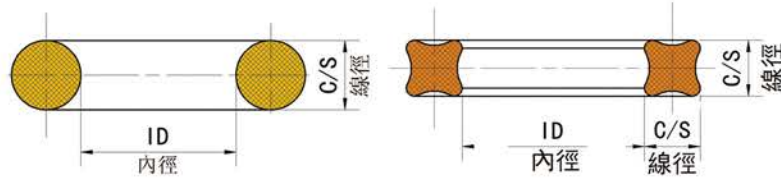

	ID	±	CS	±	ID	±	CS	±
A0913	0.986	0.01	0.116	0.004	25.04	0.25	2.95	0.1
A0914	1.047	0.01	0.116	0.004	26.59	0.25	2.95	0.1
A0916	1.171	0.01	0.116	0.004	29.74	0.25	2.95	0.1
A0918	1.355	0.012	0.116	0.004	34.42	0.3	2.95	0.1
A0920	1.475	0.014	0.118	0.004	37.47	0.36	3	0.1
A0924	1.72	0.014	0.118	0.004	43.69	0.36	3	0.1
A0928	2.09	0.018	0.118	0.004	53.09	0.46	3	0.1
A0932	2.337	0.018	0.118	0.004	59.36	0.46	3	0.1

廠家：德國歐博斯

生產材料：材料物性表中所有膠種，包含聚氨酯，鐵氟龍材料

生產尺寸：內徑3000mm以下任何規格

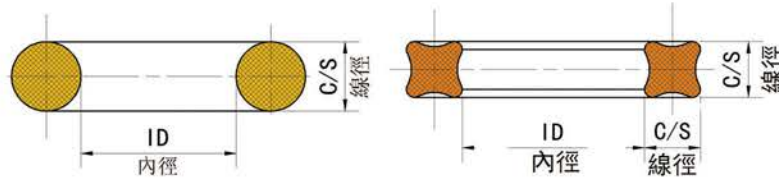

ID	+/-	CS	+/-	ID	+/-	CS	+/-	ID	+/-	CS	+/-
1.8	0.13	1.8	0.08	14.5	0.22	1.8	0.08	4.5	0.15	2.65	0.09
2	0.13	1.8	0.08	15	0.23	1.8	0.08	5.3	0.15	2.65	0.09
2.24	0.13	1.8	0.08	15.5	0.23	1.8	0.08	6	0.16	2.65	0.09
2.5	0.13	1.8	0.08	16	0.24	1.8	0.08	6.9	0.17	2.65	0.09
2.8	0.13	1.8	0.08	17	0.24	1.8	0.08	8	0.17	2.65	0.09
3.15	0.14	1.8	0.08	18	0.25	1.8	0.08	9	0.18	2.65	0.09
3.55	0.14	1.8	0.08	19	0.26	1.8	0.08	9.5	0.19	2.65	0.09
3.75	0.14	1.8	0.08	20	0.26	1.8	0.08	10	0.19	2.65	0.09
4	0.14	1.8	0.08	20.6	0.27	1.8	0.08	10.6	0.19	2.65	0.09
4.5	0.15	1.8	0.08	21.2	0.27	1.8	0.08	11.2	0.2	2.65	0.09
4.75	0.15	1.8	0.08	22.4	0.28	1.8	0.08	11.6	0.2	2.65	0.09
4.87	0.15	1.8	0.08	23	0.29	1.8	0.08	11.8	0.2	2.65	0.09
5	0.15	1.8	0.08	23.6	0.29	1.8	0.08	12.1	0.21	2.65	0.09
5.15	0.15	1.8	0.08	24.3	0.3	1.8	0.08	12.5	0.21	2.65	0.09
5.3	0.15	1.8	0.08	25	0.3	1.8	0.08	12.8	0.21	2.65	0.09
5.6	0.16	1.8	0.08	25.8	0.31	1.8	0.08	13.2	0.21	2.65	0.09
6	0.16	1.8	0.08	26.5	0.31	1.8	0.08	14	0.22	2.65	0.09
6.3	0.16	1.8	0.08	27.3	0.32	1.8	0.08	14.5	0.22	2.65	0.09
6.7	0.16	1.8	0.08	28	0.32	1.8	0.08	15	0.23	2.65	0.09
6.9	0.17	1.8	0.08	29	0.33	1.8	0.08	15.5	0.23	2.65	0.09
7.1	0.17	1.8	0.08	30	0.34	1.8	0.08	16	0.24	2.65	0.09
7.5	0.17	1.8	0.08	31.5	0.35	1.8	0.08	17	0.24	2.65	0.09
8	0.17	1.8	0.08	32.5	0.36	1.8	0.08	18	0.25	2.65	0.09
8.5	0.18	1.8	0.08	33.5	0.36	1.8	0.08	19	0.26	2.65	0.09
8.75	0.18	1.8	0.08	34.5	0.37	1.8	0.08	20	0.26	2.65	0.09
9	0.18	1.8	0.08	35.5	0.38	1.8	0.08	20.6	0.27	2.65	0.09
9.5	0.19	1.8	0.08	36.5	0.38	1.8	0.08	21.2	0.27	2.65	0.09
9.75	0.19	1.8	0.08	37.5	0.39	1.8	0.08	22.4	0.28	2.65	0.09
10	0.19	1.8	0.08	38.7	0.4	1.8	0.08	23	0.29	2.65	0.09
10.6	0.19	1.8	0.08	40	0.41	1.8	0.08	23.6	0.29	2.65	0.09
11.2	0.2	1.8	0.08	41.2	0.42	1.8	0.08	24.3	0.3	2.65	0.09
11.6	0.2	1.8	0.08	42.5	0.43	1.8	0.08	25	0.3	2.65	0.09
11.8	0.2	1.8	0.08	43.7	0.44	1.8	0.08	25.8	0.31	2.65	0.09
12.1	0.21	1.8	0.08	45	0.44	1.8	0.08	26.5	0.31	2.65	0.09
12.5	0.21	1.8	0.08	46.2	0.45	1.8	0.08	27.3	0.32	2.65	0.09
12.8	0.21	1.8	0.08	47.5	0.46	1.8	0.08	28	0.32	2.65	0.09
13.2	0.21	1.8	0.08	48.7	0.47	1.8	0.08	29	0.33	2.65	0.09
14	0.22	1.8	0.08	50	0.48	1.8	0.08	30	0.34	2.65	0.09

廠家：德國歐博斯

生產材料：材料物性表中所有膠種，包含聚氨酯，鐵氟龍材料

生產尺寸：內徑3000mm以下任何規格

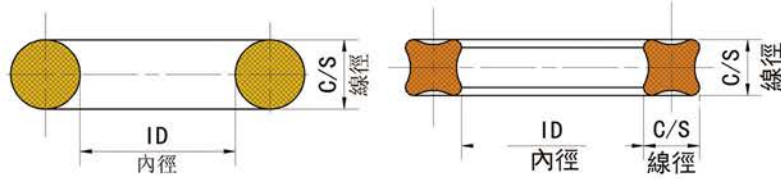

ID	+/-	CS	+/-	ID	+/-	CS	+/-	ID	+/-	CS	+/-
31.5	0.35	2.65	0.09	97.5	0.81	2.65	0.09	34.5	0.37	3.55	0.1
32.5	0.36	2.65	0.09	100	0.82	2.65	0.09	35.5	0.38	3.55	0.1
33.5	0.36	2.65	0.09	103	0.85	2.65	0.09	36.5	0.38	3.55	0.1
34.5	0.37	2.65	0.09	106	0.87	2.65	0.09	37.5	0.39	3.55	0.1
35.5	0.38	2.65	0.09	109	0.89	2.65	0.09	38.7	0.4	3.55	0.1
36.5	0.38	2.65	0.09	112	0.91	2.65	0.09	40	0.41	3.55	0.1
37.5	0.39	2.65	0.09	115	0.93	2.65	0.09	41.2	0.42	3.55	0.1
38.7	0.4	2.65	0.09	118	0.95	2.65	0.09	42.5	0.43	3.55	0.1
40	0.41	2.65	0.09	122	0.97	2.65	0.09	43.7	0.44	3.55	0.1
41.2	0.42	2.65	0.09	125	0.99	2.65	0.09	45	0.44	3.55	0.1
42.5	0.43	2.65	0.09	128	1.01	2.65	0.09	46.2	0.45	3.55	0.1
43.7	0.44	2.65	0.09	132	1.04	2.65	0.09	47.5	0.46	3.55	0.1
45	0.44	2.65	0.09	136	1.07	2.65	0.09	48.7	0.47	3.55	0.1
46.2	0.45	2.65	0.09	140	1.09	2.65	0.09	50	0.48	3.55	0.1
47.5	0.46	2.65	0.09	142.5	1.11	2.65	0.09	51.5	0.49	3.55	0.1
48.7	0.47	2.65	0.09	145	1.13	2.65	0.09	53	0.5	3.55	0.1
50	0.48	2.65	0.09	147.5	1.14	2.65	0.09	54.5	0.51	3.55	0.1
51.5	0.49	2.65	0.09	150	1.16	2.65	0.09	56	0.52	3.55	0.1
53	0.5	2.65	0.09	152.5	1.18	2.65	0.09	58	0.54	3.55	0.1
54.5	0.51	2.65	0.09	18	0.25	3.55	0.1	61.5	0.56	3.55	0.1
56	0.52	2.65	0.09	19	0.26	3.55	0.1	63	0.57	3.55	0.1
58	0.54	2.65	0.09	20	0.26	3.55	0.1	65	0.58	3.55	0.1
60	0.55	2.65	0.09	20.6	0.27	3.55	0.1	67	0.6	3.55	0.1
61.5	0.56	2.65	0.09	21.2	0.27	3.55	0.1	69	0.61	3.55	0.1
63	0.57	2.65	0.09	22.4	0.28	3.55	0.1	71	0.63	3.55	0.1
65	0.58	2.65	0.09	23	0.29	3.55	0.1	73	0.64	3.55	0.1
67	0.6	2.65	0.09	23.6	0.29	3.55	0.1	75	0.65	3.55	0.1
69	0.61	2.65	0.09	24.3	0.3	3.55	0.1	77.5	0.67	3.55	0.1
71	0.63	2.65	0.09	25	0.3	3.55	0.1	80	0.69	3.55	0.1
73	0.64	2.65	0.09	25.8	0.31	3.55	0.1	82.5	0.71	3.55	0.1
75	0.65	2.65	0.09	26.5	0.31	3.55	0.1	85	0.72	3.55	0.1
77.5	0.67	2.65	0.09	27.3	0.32	3.55	0.1	87.5	0.74	3.55	0.1
80	0.69	2.65	0.09	28	0.32	3.55	0.1	90	0.76	3.55	0.1
82.5	0.71	2.65	0.09	29	0.33	3.55	0.1	92.5	0.77	3.55	0.1
85	0.72	2.65	0.09	30	0.34	3.55	0.1	95	0.79	3.55	0.1
87.5	0.74	2.65	0.09	31.5	0.35	3.55	0.1	97.5	0.81	3.55	0.1
90	0.76	2.65	0.09	32.5	0.36	3.55	0.1	100	0.82	3.55	0.1
92.5	0.77	2.65	0.09	33.5	0.36	3.55	0.1	103	0.85	3.55	0.1

廠家：德國歐博斯

生產材料：材料物性表中所有膠種，包含聚氨酯，鐵氟龍材料

生產尺寸：內徑3000mm以下任何規格

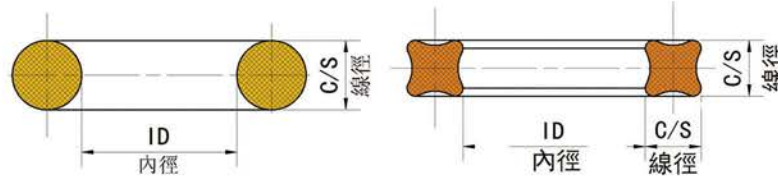

ID	+/-	CS	+/-	ID	+/-	CS	+/-	ID	+/-	CS	+/-
106	0.87	3.55	0.1	46.2	0.45	5.3	0.13	136	1.07	5.3	0.13
109	0.89	3.55	0.1	47.5	0.46	5.3	0.13	140	1.09	5.3	0.13
112	0.91	3.55	0.1	48.7	0.47	5.3	0.13	142.5	1.11	5.3	0.13
115	0.93	3.55	0.1	50	0.48	5.3	0.13	145	1.13	5.3	0.13
118	0.95	3.55	0.1	51.5	0.49	5.3	0.13	147.5	1.14	5.3	0.13
122	0.97	3.55	0.1	53	0.5	5.3	0.13	150	1.16	5.3	0.13
125	0.99	3.55	0.1	54.5	0.51	5.3	0.13	152.5	1.18	5.3	0.13
128	1.01	3.55	0.1	56	0.52	5.3	0.13	155	1.19	5.3	0.13
132	1.04	3.55	0.1	58	0.54	5.3	0.13	157.5	1.21	5.3	0.13
136	1.07	3.55	0.1	60	0.55	5.3	0.13	160	1.23	5.3	0.13
140	1.09	3.55	0.1	61.5	0.56	5.3	0.13	162.5	1.24	5.3	0.13
142.5	1.11	3.55	0.1	63	0.57	5.3	0.13	165	1.26	5.3	0.13
145	1.13	3.55	0.1	65	0.58	5.3	0.13	167.5	1.28	5.3	0.13
147.5	1.14	3.55	0.1	67	0.6	5.3	0.13	170	1.29	5.3	0.13
150	1.16	3.55	0.1	69	0.61	5.3	0.13	172.5	1.31	5.3	0.13
152.5	1.18	3.55	0.1	71	0.63	5.3	0.13	175	1.33	5.3	0.13
155	1.19	3.55	0.1	73	0.64	5.3	0.13	177.5	1.34	5.3	0.13
157.5	1.21	3.55	0.1	75	0.65	5.3	0.13	180	1.36	5.3	0.13
160	1.23	3.55	0.1	77.5	0.67	5.3	0.13	182.5	1.38	5.3	0.13
162.5	1.24	3.55	0.1	80	0.69	5.3	0.13	185	1.39	5.3	0.13
165	1.26	3.55	0.1	82.5	0.71	5.3	0.13	187.5	1.41	5.3	0.13
167.5	1.28	3.55	0.1	85	0.72	5.3	0.13	190	1.43	5.3	0.13
170	1.29	3.55	0.1	87.5	0.74	5.3	0.13	195	1.46	5.3	0.13
172.5	1.31	3.55	0.1	90	0.76	5.3	0.13	200	1.49	5.3	0.13
175	1.33	3.55	0.1	92.5	0.77	5.3	0.13	203	1.51	5.3	0.13
177.5	1.34	3.55	0.1	95	0.79	5.3	0.13	206	1.53	5.3	0.13
180	1.36	3.55	0.1	97.5	0.81	5.3	0.13	212	1.57	5.3	0.13
182.5	1.38	3.55	0.1	100	0.82	5.3	0.13	218	1.61	5.3	0.13
185	1.39	3.55	0.1	103	0.85	5.3	0.13	224	1.65	5.3	0.13
187.5	1.41	3.55	0.1	106	0.87	5.3	0.13	227	1.67	5.3	0.13
190	1.43	3.55	0.1	109	0.89	5.3	0.13	230	1.69	5.3	0.13
195	1.46	3.55	0.1	112	0.91	5.3	0.13	236	1.73	5.3	0.13
200	1.49	3.55	0.1	115	0.93	5.3	0.13	239	1.75	5.3	0.13
40	0.41	5.3	0.13	118	0.95	5.3	0.13	243	1.77	5.3	0.13
41.2	0.42	5.3	0.13	122	0.97	5.3	0.13	250	1.82	5.3	0.13
42.5	0.43	5.3	0.13	125	0.99	5.3	0.13	254	1.84	5.3	0.13
43.7	0.44	5.3	0.13	128	1.01	5.3	0.13	258	1.87	5.3	0.13
45	0.44	5.3	0.13	132	1.04	5.3	0.13	261	1.89	5.3	0.13

廠家：德國歐博斯

生產材料：材料物性表中所有膠種，包含聚氨酯，鐵氟龍材料

生產尺寸：內徑3000mm以下任何規格

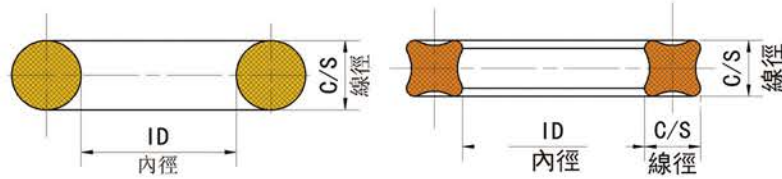

ID	+/-	CS	+/-	ID	+/-	CS	+/-	ID	+/-	CS	+/-
265	1.91	5.3	0.13	128	1.01	7	0.15	258	1.87	7	0.15
268	1.93	5.3	0.13	132	1.04	7	0.15	261	1.89	7	0.15
272	1.96	5.3	0.13	136	1.07	7	0.15	265	1.91	7	0.15
276	1.99	5.3	0.13	140	1.09	7	0.15	268	1.93	7	0.15
280	2.01	5.3	0.13	142.5	1.11	7	0.15	272	1.96	7	0.15
283	2.03	5.3	0.13	145	1.13	7	0.15	276	1.99	7	0.15
286	2.05	5.3	0.13	147.5	1.14	7	0.15	280	2.01	7	0.15
290	2.08	5.3	0.13	150	1.16	7	0.15	283	2.03	7	0.15
295	2.11	5.3	0.13	152.5	1.18	7	0.15	286	2.05	7	0.15
300	2.14	5.3	0.13	155	1.19	7	0.15	290	2.08	7	0.15
303	2.16	5.3	0.13	157.5	1.21	7	0.15	295	2.11	7	0.15
307	2.19	5.3	0.13	160	1.23	7	0.15	300	2.14	7	0.15
311	2.21	5.3	0.13	162.5	1.24	7	0.15	303	2.16	7	0.15
315	2.24	5.3	0.13	165	1.26	7	0.15	307	2.19	7	0.15
320	2.27	5.3	0.13	167.5	1.28	7	0.15	311	2.21	7	0.15
325	2.3	5.3	0.13	170	1.29	7	0.15	315	2.24	7	0.15
330	2.33	5.3	0.13	172.5	1.31	7	0.15	320	2.27	7	0.15
335	2.36	5.3	0.13	175	1.33	7	0.15	325	2.3	7	0.15
340	2.4	5.3	0.13	177.5	1.34	7	0.15	330	2.33	7	0.15
345	2.43	5.3	0.13	180	1.36	7	0.15	335	2.36	7	0.15
350	2.46	5.3	0.13	182.5	1.38	7	0.15	340	2.4	7	0.15
355	2.49	5.3	0.13	185	1.39	7	0.15	345	2.43	7	0.15
360	2.52	5.3	0.13	187.5	1.41	7	0.15	350	2.46	7	0.15
365	2.56	5.3	0.13	190	1.43	7	0.15	355	2.49	7	0.15
370	2.59	5.3	0.13	195	1.46	7	0.15	360	2.52	7	0.15
375	2.62	5.3	0.13	200	1.49	7	0.15	365	2.56	7	0.15
379	2.64	5.3	0.13	203	1.51	7	0.15	370	2.59	7	0.15
383	2.67	5.3	0.13	206	1.53	7	0.15	375	2.62	7	0.15
387	2.7	5.3	0.13	212	1.57	7	0.15	379	2.64	7	0.15
391	2.72	5.3	0.13	218	1.61	7	0.15	383	2.67	7	0.15
395	2.75	5.3	0.13	224	1.65	7	0.15	387	2.7	7	0.15
400	2.78	5.3	0.13	227	1.67	7	0.15	391	2.72	7	0.15
109	0.89	7	0.15	230	1.69	7	0.15	395	2.75	7	0.15
112	0.91	7	0.15	236	1.73	7	0.15	400	2.78	7	0.15
115	0.93	7	0.15	239	1.75	7	0.15	406	2.82	7	0.15
118	0.95	7	0.15	243	1.77	7	0.15	412	2.85	7	0.15
122	0.97	7	0.15	250	1.82	7	0.15	418	2.89	7	0.15
125	0.99	7	0.15	254	1.84	7	0.15	425	2.94	7	0.15

廠家：德國歐博斯

生產材料：材料物性表中所有膠種，包含聚氨酯，鐵氟龍材料

生產尺寸：內徑3000mm以下任何規格

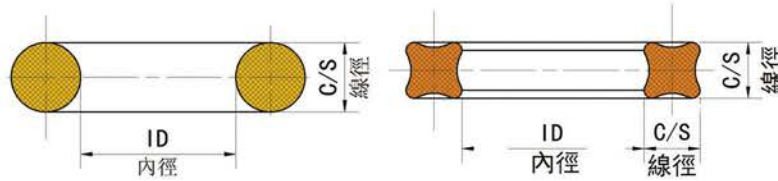

ID	+/-	CS	+/-	ID	+/-	CS	+/-	ID	+/-	CS	+/-
429	2.96	7	0.15	0.11	0.005	0.071	0.003	0.669	0.009	0.071	0.003
433	2.99	7	0.15	0.124	0.006	0.071	0.003	0.709	0.01	0.071	0.003
437	3.01	7	0.15	0.14	0.006	0.071	0.003	0.748	0.01	0.071	0.003
443	3.05	7	0.15	0.148	0.006	0.071	0.003	0.787	0.01	0.071	0.003
450	3.09	7	0.15	0.157	0.006	0.071	0.003	0.811	0.011	0.071	0.003
456	3.13	7	0.15	0.177	0.006	0.071	0.003	0.835	0.011	0.071	0.003
462	3.17	7	0.15	0.187	0.006	0.071	0.003	0.882	0.011	0.071	0.003
466	3.19	7	0.15	0.192	0.006	0.071	0.003	0.906	0.011	0.071	0.003
470	3.22	7	0.15	0.197	0.006	0.071	0.003	0.929	0.011	0.071	0.003
475	3.25	7	0.15	0.203	0.006	0.071	0.003	0.957	0.012	0.071	0.003
479	3.28	7	0.15	0.209	0.006	0.071	0.003	0.984	0.012	0.071	0.003
483	3.3	7	0.15	0.22	0.006	0.071	0.003	1.016	0.012	0.071	0.003
487	3.33	7	0.15	0.236	0.006	0.071	0.003	1.043	0.012	0.071	0.003
493	3.36	7	0.15	0.248	0.006	0.071	0.003	1.075	0.013	0.071	0.003
500	3.41	7	0.15	0.264	0.006	0.071	0.003	1.102	0.013	0.071	0.003
508	3.46	7	0.15	0.272	0.007	0.071	0.003	1.142	0.013	0.071	0.003
515	3.5	7	0.15	0.28	0.007	0.071	0.003	1.181	0.013	0.071	0.003
523	3.55	7	0.15	0.295	0.007	0.071	0.003	1.24	0.014	0.071	0.003
530	3.6	7	0.15	0.315	0.007	0.071	0.003	1.28	0.014	0.071	0.003
538	3.65	7	0.15	0.335	0.007	0.071	0.003	1.319	0.014	0.071	0.003
545	3.69	7	0.15	0.344	0.007	0.071	0.003	1.358	0.015	0.071	0.003
553	3.74	7	0.15	0.354	0.007	0.071	0.003	1.398	0.015	0.071	0.003
560	3.78	7	0.15	0.374	0.007	0.071	0.003	1.437	0.015	0.071	0.003
570	3.85	7	0.15	0.384	0.007	0.071	0.003	1.476	0.015	0.071	0.003
580	3.91	7	0.15	0.394	0.007	0.071	0.003	1.524	0.016	0.071	0.003
590	3.97	7	0.15	0.417	0.007	0.071	0.003	1.575	0.016	0.071	0.003
600	4.03	7	0.15	0.441	0.008	0.071	0.003	1.622	0.017	0.071	0.003
608	4.08	7	0.15	0.457	0.008	0.071	0.003	1.673	0.017	0.071	0.003
615	4.12	7	0.15	0.465	0.008	0.071	0.003	1.72	0.017	0.071	0.003
623	4.17	7	0.15	0.476	0.008	0.071	0.003	1.772	0.017	0.071	0.003
630	4.22	7	0.15	0.492	0.008	0.071	0.003	1.819	0.018	0.071	0.003
640	4.28	7	0.15	0.504	0.008	0.071	0.003	1.87	0.018	0.071	0.003
650	4.34	7	0.15	0.52	0.008	0.071	0.003	1.917	0.019	0.071	0.003
660	4.4	7	0.15	0.551	0.009	0.071	0.003	1.969	0.019	0.071	0.003
670	4.47	7	0.15	0.571	0.009	0.071	0.003	0.177	0.006	0.104	0.004
0.071	0.005	0.071	0.003	0.591	0.009	0.071	0.003	0.209	0.006	0.104	0.004
0.079	0.005	0.071	0.003	0.61	0.009	0.071	0.003	0.236	0.006	0.104	0.004
0.088	0.005	0.071	0.003	0.63	0.009	0.071	0.003	0.272	0.007	0.104	0.004

廠家：德國歐博斯

生產材料：材料物性表中所有膠種，包含聚氨酯，鐵氟龍材料

生產尺寸：內徑3000mm以下任何規格

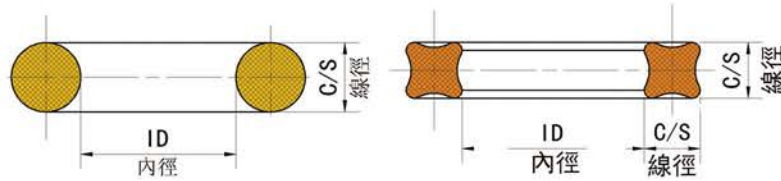

ID	+/-	CS	+/-	ID	+/-	CS	+/-	ID	+/-	CS	+/-
0.354	0.007	0.104	0.004	1.437	0.015	0.104	0.004	4.291	0.035	0.104	0.004
0.374	0.007	0.104	0.004	1.476	0.015	0.104	0.004	4.409	0.036	0.104	0.004
0.394	0.007	0.104	0.004	1.524	0.016	0.104	0.004	4.528	0.037	0.104	0.004
0.417	0.007	0.104	0.004	1.575	0.016	0.104	0.004	4.646	0.037	0.104	0.004
0.441	0.008	0.104	0.004	1.622	0.017	0.104	0.004	4.803	0.038	0.104	0.004
0.457	0.008	0.104	0.004	1.673	0.017	0.104	0.004	4.921	0.039	0.104	0.004
0.465	0.008	0.104	0.004	1.72	0.017	0.104	0.004	5.039	0.04	0.104	0.004
0.476	0.008	0.104	0.004	1.772	0.017	0.104	0.004	5.197	0.041	0.104	0.004
0.492	0.008	0.104	0.004	1.819	0.018	0.104	0.004	5.354	0.042	0.104	0.004
0.504	0.008	0.104	0.004	1.87	0.018	0.104	0.004	5.512	0.043	0.104	0.004
0.52	0.008	0.104	0.004	1.917	0.019	0.104	0.004	5.61	0.044	0.104	0.004
0.551	0.009	0.104	0.004	1.969	0.019	0.104	0.004	5.709	0.044	0.104	0.004
0.571	0.009	0.104	0.004	2.028	0.019	0.104	0.004	5.807	0.045	0.104	0.004
0.591	0.009	0.104	0.004	2.087	0.02	0.104	0.004	5.906	0.046	0.104	0.004
0.61	0.009	0.104	0.004	2.146	0.02	0.104	0.004	6.004	0.046	0.104	0.004
0.63	0.009	0.104	0.004	2.205	0.02	0.104	0.004	0.709	0.01	0.14	0.004
0.669	0.009	0.104	0.004	2.283	0.021	0.104	0.004	0.748	0.01	0.14	0.004
0.709	0.01	0.104	0.004	2.362	0.022	0.104	0.004	0.787	0.01	0.14	0.004
0.748	0.01	0.104	0.004	2.421	0.022	0.104	0.004	0.811	0.011	0.14	0.004
0.787	0.01	0.104	0.004	2.48	0.022	0.104	0.004	0.835	0.011	0.14	0.004
0.811	0.011	0.104	0.004	2.559	0.023	0.104	0.004	0.882	0.011	0.14	0.004
0.835	0.011	0.104	0.004	2.638	0.024	0.104	0.004	0.906	0.011	0.14	0.004
0.882	0.011	0.104	0.004	2.717	0.024	0.104	0.004	0.929	0.011	0.14	0.004
0.906	0.011	0.104	0.004	2.795	0.025	0.104	0.004	0.957	0.012	0.14	0.004
0.929	0.011	0.104	0.004	2.874	0.025	0.104	0.004	0.984	0.012	0.14	0.004
0.957	0.012	0.104	0.004	2.953	0.026	0.104	0.004	1.016	0.012	0.14	0.004
0.984	0.012	0.104	0.004	3.051	0.026	0.104	0.004	1.043	0.012	0.14	0.004
1.016	0.012	0.104	0.004	3.15	0.027	0.104	0.004	1.075	0.013	0.14	0.004
1.043	0.012	0.104	0.004	3.248	0.028	0.104	0.004	1.102	0.013	0.14	0.004
1.075	0.013	0.104	0.004	3.346	0.028	0.104	0.004	1.142	0.013	0.14	0.004
1.102	0.013	0.104	0.004	3.445	0.029	0.104	0.004	1.181	0.013	0.14	0.004
1.142	0.013	0.104	0.004	3.543	0.03	0.104	0.004	1.24	0.014	0.14	0.004
1.181	0.013	0.104	0.004	3.642	0.03	0.104	0.004	1.28	0.014	0.14	0.004
1.24	0.014	0.104	0.004	3.74	0.031	0.104	0.004	1.319	0.014	0.14	0.004
1.28	0.014	0.104	0.004	3.839	0.032	0.104	0.004	1.358	0.015	0.14	0.004
1.319	0.014	0.104	0.004	3.937	0.032	0.104	0.004	1.398	0.015	0.14	0.004
1.358	0.015	0.104	0.004	4.055	0.033	0.104	0.004	1.437	0.015	0.14	0.004
1.398	0.015	0.104	0.004	4.173	0.034	0.104	0.004	1.476	0.015	0.14	0.004

廠家：德國歐博斯

生產材料：材料物性表中所有膠種，包含聚氨酯，鐵氟龍材料

生產尺寸：內徑3000mm以下任何規格

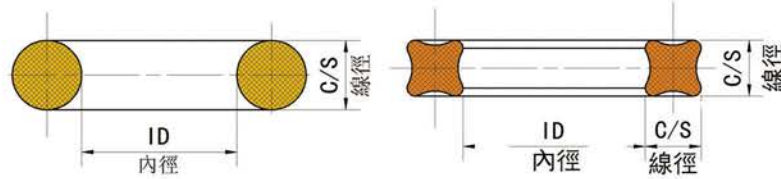

ID	+/-	CS	+/-	ID	+/-	CS	+/-	ID	+/-	CS	+/-
1.524	0.016	0.14	0.004	4.528	0.037	0.14	0.004	1.969	0.019	0.209	0.005
1.575	0.016	0.14	0.004	4.646	0.037	0.14	0.004	2.028	0.019	0.209	0.005
1.622	0.017	0.14	0.004	4.803	0.038	0.14	0.004	2.087	0.02	0.209	0.005
1.673	0.017	0.14	0.004	4.921	0.039	0.14	0.004	2.146	0.02	0.209	0.005
1.72	0.017	0.14	0.004	5.039	0.04	0.14	0.004	2.205	0.02	0.209	0.005
1.772	0.017	0.14	0.004	5.197	0.041	0.14	0.004	2.283	0.021	0.209	0.005
1.819	0.018	0.14	0.004	5.354	0.042	0.14	0.004	2.362	0.022	0.209	0.005
1.87	0.018	0.14	0.004	5.512	0.043	0.14	0.004	2.421	0.022	0.209	0.005
	0.019	0.14	0.004	5.61	0.044	0.14	0.004	2.48	0.022	0.209	0.005
1.969	0.019	0.14	0.004	5.709	0.044	0.14	0.004	2.559	0.023	0.209	0.005
2.028	0.019	0.14	0.004	5.807	0.045	0.14	0.004	2.638	0.024	0.209	0.005
2.087	0.02	0.14	0.004	5.906	0.046	0.14	0.004	2.717	0.024	0.209	0.005
2.146	0.02	0.14	0.004	6.004	0.046	0.14	0.004	2.795	0.025	0.209	0.005
2.205	0.02	0.14	0.004	6.102	0.047	0.14	0.004	2.874	0.025	0.209	0.005
2.283	0.021	0.14	0.004	6.201	0.048	0.14	0.004	2.953	0.026	0.209	0.005
2.362	0.022	0.14	0.004	6.299	0.048	0.14	0.004	3.051	0.026	0.209	0.005
2.421	0.022	0.14	0.004	6.398	0.049	0.14	0.004	3.15	0.027	0.209	0.005
2.48	0.022	0.14	0.004	6.496	0.05	0.14	0.004	3.248	0.028	0.209	0.005
2.559	0.023	0.14	0.004	6.594	0.05	0.14	0.004	3.346	0.028	0.209	0.005
2.638	0.024	0.14	0.004	6.693	0.051	0.14	0.004	3.445	0.029	0.209	0.005
2.717	0.024	0.14	0.004	6.791	0.052	0.14	0.004	3.543	0.03	0.209	0.005
2.795	0.025	0.14	0.004	6.89	0.052	0.14	0.004	3.642	0.03	0.209	0.005
2.874	0.025	0.14	0.004	6.988	0.053	0.14	0.004	3.74	0.031	0.209	0.005
2.953	0.026	0.14	0.004	7.087	0.054	0.14	0.004	3.839	0.032	0.209	0.005
3.051	0.026	0.14	0.004	7.185	0.054	0.14	0.004	3.937	0.032	0.209	0.005
3.15	0.027	0.14	0.004	7.283	0.055	0.14	0.004	4.055	0.033	0.209	0.005
3.248	0.028	0.14	0.004	7.382	0.056	0.14	0.004	4.173	0.034	0.209	0.005
3.346	0.028	0.14	0.004	7.48	0.056	0.14	0.004	4.291	0.035	0.209	0.005
3.445	0.029	0.14	0.004	7.677	0.057	0.14	0.004	4.409	0.036	0.209	0.005
3.543	0.03	0.14	0.004	7.874	0.059	0.14	0.004	4.528	0.037	0.209	0.005
3.642	0.03	0.14	0.004	1.575	0.016	0.209	0.005	4.646	0.037	0.209	0.005
3.74	0.031	0.14	0.004	1.622	0.017	0.209	0.005	4.803	0.038	0.209	0.005
3.839	0.032	0.14	0.004	1.673	0.017	0.209	0.005	4.921	0.039	0.209	0.005
3.937	0.032	0.14	0.004	1.72	0.017	0.209	0.005	5.039	0.04	0.209	0.005
4.055	0.033	0.14	0.004	1.772	0.017	0.209	0.005	5.197	0.041	0.209	0.005
4.173	0.034	0.14	0.004	1.819	0.018	0.209	0.005	5.354	0.042	0.209	0.005
4.291	0.035	0.14	0.004	1.87	0.018	0.209	0.005	5.512	0.043	0.209	0.005
4.409	0.036	0.14	0.004	1.917	0.019	0.209	0.005	5.61	0.044	0.209	0.005

廠家：德國歐博斯

生產材料：材料物性表中所有膠種，包含聚氨酯，鐵氟龍材料

生產尺寸：內徑3000mm以下任何規格

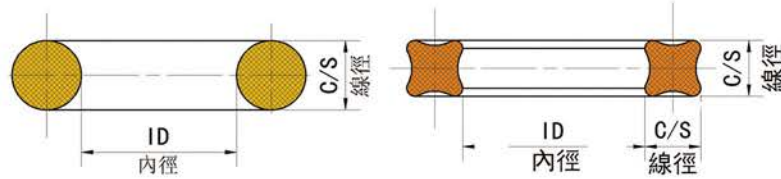

ID	+/-	CS	+/-	ID	+/-	CS	+/-	ID	+/-	CS	+/-
5.709	0.044	0.209	0.005	10.866	0.078	0.209	0.005	5.61	0.044	0.276	0.006
5.807	0.045	0.209	0.005	11.024	0.079	0.209	0.005	5.709	0.044	0.276	0.006
5.906	0.046	0.209	0.005	11.142	0.08	0.209	0.005	5.807	0.045	0.276	0.006
6.004	0.046	0.209	0.005	11.26	0.081	0.209	0.005	5.906	0.046	0.276	0.006
6.102	0.047	0.209	0.005	11.417	0.082	0.209	0.005	6.004	0.046	0.276	0.006
6.201	0.048	0.209	0.005	11.614	0.083	0.209	0.005	6.102	0.047	0.276	0.006
6.299	0.048	0.209	0.005	11.811	0.084	0.209	0.005	6.201	0.048	0.276	0.006
6.398	0.049	0.209	0.005	11.929	0.085	0.209	0.005	6.299	0.048	0.276	0.006
6.496	0.05	0.209	0.005	12.087	0.086	0.209	0.005	6.398	0.049	0.276	0.006
6.594	0.05	0.209	0.005	12.244	0.087	0.209	0.005	6.496	0.05	0.276	0.006
6.693	0.051	0.209	0.005	12.402	0.088	0.209	0.005	6.594	0.05	0.276	0.006
6.791	0.052	0.209	0.005	12.598	0.089	0.209	0.005	6.693	0.051	0.276	0.006
6.89	0.052	0.209	0.005	12.795	0.091	0.209	0.005	6.791	0.052	0.276	0.006
6.988	0.053	0.209	0.005	12.992	0.092	0.209	0.005	6.89	0.052	0.276	0.006
7.087	0.054	0.209	0.005	13.189	0.093	0.209	0.005	6.988	0.053	0.276	0.006
7.185	0.054	0.209	0.005	13.386	0.094	0.209	0.005	7.087	0.054	0.276	0.006
7.283	0.055	0.209	0.005	13.583	0.096	0.209	0.005	7.185	0.054	0.276	0.006
7.382	0.056	0.209	0.005	13.78	0.097	0.209	0.005	7.283	0.055	0.276	0.006
7.48	0.056	0.209	0.005	13.976	0.098	0.209	0.005	7.382	0.056	0.276	0.006
7.677	0.057	0.209	0.005	14.173	0.099	0.209	0.005	7.48	0.056	0.276	0.006
7.874	0.059	0.209	0.005	14.37	0.101	0.209	0.005	7.677	0.057	0.276	0.006
7.992	0.059	0.209	0.005	14.567	0.102	0.209	0.005	7.874	0.059	0.276	0.006
8.11	0.06	0.209	0.005	14.764	0.103	0.209	0.005	7.992	0.059	0.276	0.006
8.346	0.062	0.209	0.005	14.921	0.104	0.209	0.005	8.11	0.06	0.276	0.006
8.583	0.063	0.209	0.005	15.079	0.105	0.209	0.005	8.346	0.062	0.276	0.006
8.819	0.065	0.209	0.005	15.236	0.106	0.209	0.005	8.583	0.063	0.276	0.006
8.937	0.066	0.209	0.005	15.394	0.107	0.209	0.005	8.819	0.065	0.276	0.006
9.055	0.067	0.209	0.005	15.551	0.108	0.209	0.005	8.937	0.066	0.276	0.006
9.291	0.068	0.209	0.005	15.748	0.109	0.209	0.005	9.055	0.067	0.276	0.006
9.409	0.069	0.209	0.005	4.291	0.035	0.276	0.006	9.291	0.068	0.276	0.006
9.567	0.07	0.209	0.005	4.409	0.036	0.276	0.006	9.409	0.069	0.276	0.006
9.843	0.072	0.209	0.005	4.528	0.037	0.276	0.006	9.567	0.07	0.276	0.006
10	0.072	0.209	0.005	4.646	0.037	0.276	0.006	9.843	0.072	0.276	0.006
10.157	0.074	0.209	0.005	4.803	0.038	0.276	0.006	10	0.072	0.276	0.006
10.276	0.074	0.209	0.005	4.921	0.039	0.276	0.006	10.157	0.074	0.276	0.006
10.433	0.075	0.209	0.005	5.039	0.04	0.276	0.006	10.276	0.074	0.276	0.006
10.551	0.076	0.209	0.005	5.197	0.041	0.276	0.006	10.433	0.075	0.276	0.006
10.709	0.077	0.209	0.005	5.354	0.042	0.276	0.006	10.551	0.076	0.276	0.006

廠家：德國歐博斯

生產材料：材料物性表中所有膠種，包含聚氨酯，鐵氟龍材料

生產尺寸：內徑3000mm以下任何規格

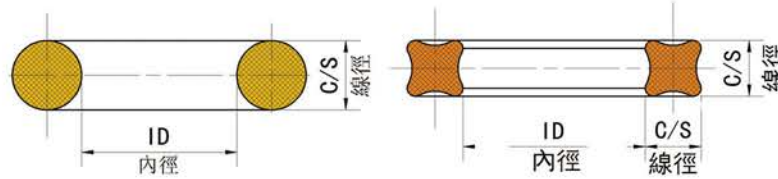

ID	+/-	CS	+/-	ID	+/-	CS	+/-
10.709	0.077	0.276	0.006	17.717	0.122	0.276	0.006
10.866	0.078	0.276	0.006	17.953	0.123	0.276	0.006
11.024	0.079	0.276	0.006	18.189	0.125	0.276	0.006
11.142	0.08	0.276	0.006	18.346	0.126	0.276	0.006
11.26	0.081	0.276	0.006	18.504	0.127	0.276	0.006
11.417	0.082	0.276	0.006	18.701	0.128	0.276	0.006
11.614	0.083	0.276	0.006	18.858	0.129	0.276	0.006
11.811	0.084	0.276	0.006	19.016	0.13	0.276	0.006
11.929	0.085	0.276	0.006	19.173	0.131	0.276	0.006
12.087	0.086	0.276	0.006	19.409	0.132	0.276	0.006
12.244	0.087	0.276	0.006	19.685	0.134	0.276	0.006
12.402	0.088	0.276	0.006	20	0.136	0.276	0.006
12.598	0.089	0.276	0.006	20.276	0.138	0.276	0.006
12.795	0.091	0.276	0.006	20.591	0.14	0.276	0.006
12.992	0.092	0.276	0.006	20.866	0.142	0.276	0.006
13.189	0.093	0.276	0.006	21.181	0.144	0.276	0.006
13.386	0.094	0.276	0.006	21.457	0.145	0.276	0.006
13.583	0.096	0.276	0.006	21.772	0.147	0.276	0.006
13.78	0.097	0.276	0.006	22.047	0.149	0.276	0.006
13.976	0.098	0.276	0.006	22.441	0.152	0.276	0.006
14.173	0.099	0.276	0.006	22.835	0.154	0.276	0.006
14.37	0.101	0.276	0.006	23.228	0.156	0.276	0.006
14.567	0.102	0.276	0.006	23.622	0.159	0.276	0.006
14.764	0.103	0.276	0.006	23.937	0.161	0.276	0.006
14.921	0.104	0.276	0.006	24.213	0.162	0.276	0.006
15.079	0.105	0.276	0.006	24.528	0.164	0.276	0.006
15.236	0.106	0.276	0.006	24.803	0.166	0.276	0.006
15.394	0.107	0.276	0.006	25.197	0.169	0.276	0.006
15.551	0.108	0.276	0.006	25.591	0.171	0.276	0.006
15.748	0.109	0.276	0.006	25.984	0.173	0.276	0.006
15.984	0.111	0.276	0.006	26.378	0.176	0.276	0.006
16.22	0.112	0.276	0.006				
16.457	0.114	0.276	0.006				
16.732	0.116	0.276	0.006				
16.89	0.117	0.276	0.006				
17.047	0.118	0.276	0.006				
17.205	0.119	0.276	0.006				
17.441	0.12	0.276	0.006				

廠家：德國歐博斯

生產材料：材料物性表中所有膠種，包含聚氨酯，鐵氟龍材料

生產尺寸：內徑3000mm以下任何規格

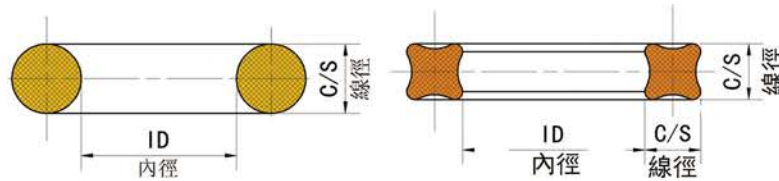

JIS B 2401	ID	+/-	CS	+/-	ID	+/-	CS	+/-
G25	24.4	0.25	3.1	0.1	0.961	0.01	0.122	0.004
G30	29.4	0.29	3.1	0.1	1.157	0.011	0.122	0.004
G35	34.4	0.33	3.1	0.1	1.354	0.013	0.122	0.004
G40	39.4	0.37	3.1	0.1	1.551	0.015	0.122	0.004
G45	44.4	0.41	3.1	0.1	1.748	0.016	0.122	0.004
G50	49.4	0.45	3.1	0.1	1.945	0.018	0.122	0.004
G55	54.4	0.49	3.1	0.1	2.142	0.019	0.122	0.004
G60	59.4	0.53	3.1	0.1	2.339	0.021	0.122	0.004
G65	64.4	0.57	3.1	0.1	2.535	0.022	0.122	0.004
G70	69.4	0.61	3.1	0.1	2.732	0.024	0.122	0.004
G75	74.4	0.65	3.1	0.1	2.929	0.026	0.122	0.004
G80	79.4	0.69	3.1	0.1	3.126	0.027	0.122	0.004
G85	84.4	0.73	3.1	0.1	3.323	0.029	0.122	0.004
G90	89.4	0.77	3.1	0.1	3.52	0.03	0.122	0.004
G95	94.4	0.81	3.1	0.1	3.717	0.032	0.122	0.004
G100	99.4	0.85	3.1	0.1	3.913	0.033	0.122	0.004
G105	104.4	0.87	3.1	0.1	4.11	0.034	0.122	0.004
G110	109.4	0.91	3.1	0.1	4.307	0.036	0.122	0.004
G115	114.4	0.94	3.1	0.1	4.504	0.037	0.122	0.004
G120	119.4	0.98	3.1	0.1	4.701	0.039	0.122	0.004
G125	124.4	1.01	3.1	0.1	4.898	0.04	0.122	0.004
G130	129.4	1.05	3.1	0.1	5.094	0.041	0.122	0.004
G135	134.4	1.08	3.1	0.1	5.291	0.043	0.122	0.004
G140	139.4	1.12	3.1	0.1	5.488	0.044	0.122	0.004
G145	144.4	1.16	3.1	0.1	5.685	0.046	0.122	0.004
G150	149.3	1.19	5.7	0.13	5.878	0.047	0.224	0.005
G155	154.3	1.23	5.7	0.13	6.075	0.048	0.224	0.005
G160	159.3	1.26	5.7	0.13	6.272	0.05	0.224	0.005
G165	164.3	1.3	5.7	0.13	6.468	0.051	0.224	0.005
G170	169.3	1.33	5.7	0.13	6.665	0.052	0.224	0.005

廠家：德國歐博斯

生產材料：材料物性表中所有膠種，包含聚氨酯，鐵氟龍材料

生產尺寸：內徑3000mm以下任何規格

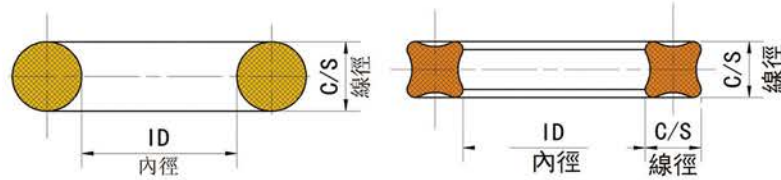

JIS B 2401	ID	+/-	CS	+/-	ID	+/-	CS	+/-
G175	174.3	1.37	5.7	0.13	6.862	0.054	0.224	0.005
G180	179.3	1.4	5.7	0.13	7.059	0.055	0.224	0.005
G185	184.3	1.44	5.7	0.13	7.256	0.057	0.224	0.005
G190	189.3	1.47	5.7	0.13	7.453	0.058	0.224	0.005
G195	194.3	1.51	5.7	0.13	7.65	0.059	0.224	0.005
G200	199.3	1.55	5.7	0.13	7.846	0.061	0.224	0.005
G205	204.3	1.58	5.7	0.13	8.043	0.062	0.224	0.005
G210	209.3	1.61	5.7	0.13	8.24	0.063	0.224	0.005
G215	214.3	1.65	5.7	0.13	8.437	0.065	0.224	0.005
G220	219.3	1.68	5.7	0.13	8.634	0.066	0.224	0.005
G225	224.3	1.71	5.7	0.13	8.831	0.067	0.224	0.005
G230	229.3	1.73	5.7	0.13	9.028	0.068	0.224	0.005
G235	234.3	1.78	5.7	0.13	9.224	0.07	0.224	0.005
G240	239.3	1.81	5.7	0.13	9.421	0.071	0.224	0.005
G245	244.3	1.85	5.7	0.13	9.618	0.073	0.224	0.005
G250	249.3	1.88	5.7	0.13	9.815	0.074	0.224	0.005
G255	254.3	1.91	5.7	0.13	10.012	0.075	0.224	0.005
G260	259.3	1.94	5.7	0.13	10.209	0.076	0.224	0.005
G265	264.3	1.98	5.7	0.13	10.405	0.078	0.224	0.005
G270	269.3	2.01	5.7	0.13	10.602	0.079	0.224	0.005
G275	274.3	2.04	5.7	0.13	10.799	0.08	0.224	0.005
G280	279.3	2.07	5.7	0.13	10.996	0.081	0.224	0.005
G285	284.3	2.11	5.7	0.13	11.193	0.083	0.224	0.005
G290	289.3	2.14	5.7	0.13	11.39	0.084	0.224	0.005
G295	294.3	2.17	5.7	0.13	11.587	0.085	0.224	0.005
G300	299.3	2.2	5.7	0.13	11.783	0.087	0.224	0.005
G305	304.3	2.24	5.7	0.13	11.98	0.088	0.224	0.005
G310	309.3	2.27	5.7	0.13	12.177	0.089	0.224	0.005
G315	314.3	2.3	5.7	0.13	12.374	0.091	0.224	0.005
G320	319.3	2.33	5.7	0.13	12.571	0.092	0.224	0.005

廠家：德國歐博斯

生產材料：材料物性表中所有膠種，包含聚氨酯，鐵氟龍材料

生產尺寸：內徑3000mm以下任何規格

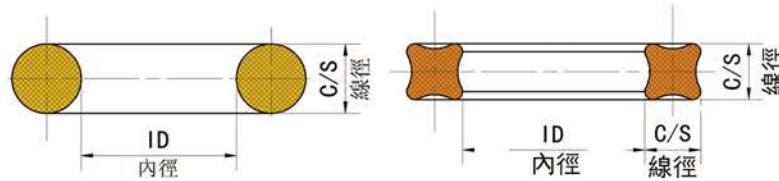

JIS B 2401	ID	+/-	CS	+/-	ID	+/-	CS	+/-
G325	324.3	2.36	5.7	0.13	12.768	0.093	0.224	0.005
G330	329.3	2.39	5.7	0.13	12.965	0.094	0.224	0.005
G335	334.3	2.42	5.7	0.13	13.161	0.095	0.224	0.005
G340	339.3	2.45	5.7	0.13	13.358	0.096	0.224	0.005
G345	344.3	2.48	5.7	0.13	13.555	0.098	0.224	0.005
G350	349.3	2.51	5.7	0.13	13.752	0.099	0.224	0.005
G355	354.3	2.54	5.7	0.13	13.949	0.1	0.224	0.005
G360	359.3	2.57	5.7	0.13	14.146	0.101	0.224	0.005
G365	364.3	2.6	5.7	0.13	14.342	0.102	0.224	0.005
G370	369.3	2.63	5.7	0.13	14.539	0.104	0.224	0.005
G375	374.3	2.67	5.7	0.13	14.736	0.105	0.224	0.005
G380	379.3	2.7	5.7	0.13	14.933	0.106	0.224	0.005
G385	384.3	2.73	5.7	0.13	15.13	0.107	0.224	0.005
G390	389.3	2.77	5.7	0.13	15.327	0.109	0.224	0.005
G395	394.3	2.79	5.7	0.13	15.524	0.11	0.224	0.005
G400	399.3	2.82	5.7	0.13	15.72	0.111	0.224	0.005
G405	404.3	3	5.7	0.13	15.917	0.118	0.224	0.005
G410	409.3	3	5.7	0.13	16.114	0.118	0.224	0.005
G415	414.3	3	5.7	0.13	16.311	0.118	0.224	0.005
G420	419.3	3	5.7	0.13	16.508	0.118	0.224	0.005
G425	424.3	3	5.7	0.13	16.705	0.118	0.224	0.005
G430	429.3	3	5.7	0.13	16.902	0.118	0.224	0.005
G435	434.3	3	5.7	0.13	17.098	0.118	0.224	0.005
G440	439.3	3	5.7	0.13	17.295	0.118	0.224	0.005
G445	444.3	3	5.7	0.13	17.492	0.118	0.224	0.005
G450	449.3	3	5.7	0.13	17.689	0.118	0.224	0.005
G455	454.3	3.3	5.7	0.13	17.886	0.13	0.224	0.005
G460	459.3	3.3	5.7	0.13	18.083	0.13	0.224	0.005
G465	464.3	3.3	5.7	0.13	18.279	0.13	0.224	0.005
G470	469.3	3.3	5.7	0.13	18.476	0.13	0.224	0.005

廠家：德國歐博斯

生產材料：材料物性表中所有膠種，包含聚氨酯，鐵氟龍材料

生產尺寸：內徑3000mm以下任何規格

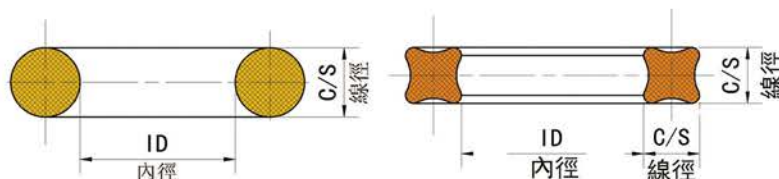

JIS B 2401	ID	+/-	CS	+/-	ID	+/-	CS	+/-
G475	474.3	3.3	5.7	0.13	18.673	0.13	0.224	0.005
G480	479.3	3.3	5.7	0.13	18.87	0.13	0.224	0.005
G485	484.3	3.3	5.7	0.13	19.067	0.13	0.224	0.005
G490	489.3	3.3	5.7	0.13	19.264	0.13	0.224	0.005
G495	494.3	3.3	5.7	0.13	19.461	0.13	0.224	0.005
G500	499.3	3.3	5.7	0.13	19.657	0.13	0.224	0.005
G510	509.3	3.47	5.7	0.13	20.051	0.136	0.224	0.005
G520	519.3	3.53	5.7	0.13	20.445	0.139	0.224	0.005
G530	529.3	3.59	5.7	0.13	20.839	0.141	0.224	0.005
G540	539.3	3.65	5.7	0.13	21.232	0.144	0.224	0.005
G550	549.3	3.72	5.7	0.13	21.626	0.146	0.224	0.005
G560	559.3	3.78	5.7	0.13	22.02	0.149	0.224	0.005
G570	569.3	3.84	5.7	0.13	22.413	0.151	0.224	0.005
G580	579.3	3.9	5.7	0.13	22.807	0.154	0.224	0.005
G590	589.3	3.97	5.7	0.13	23.201	0.156	0.224	0.005
G600	599.3	4.03	5.7	0.13	23.594	0.159	0.224	0.005
G605	604.3	4.06	5.7	0.13	23.791	0.16	0.224	0.005
G860	859.3	5.63	5.7	0.13	33.831	0.222	0.224	0.005
G910	909.3	5.93	5.7	0.13	35.799	0.234	0.224	0.005

JIS B 2401	ID	+/-	CS	+/-	ID	+/-	CS	+/-
P3	2.8	0.14	1.9	0.07	0.11	0.006	0.075	0.003
P4	3.8	0.14	1.9	0.07	0.15	0.006	0.075	0.003
P5	4.8	0.15	1.9	0.07	0.189	0.006	0.075	0.003
P6	5.8	0.15	1.9	0.07	0.228	0.006	0.075	0.003
P7	6.8	0.16	1.9	0.07	0.268	0.006	0.075	0.003
P8	7.8	0.16	1.9	0.07	0.307	0.006	0.075	0.003
P9	8.8	0.17	1.9	0.07	0.346	0.007	0.075	0.003
P10	9.8	0.17	1.9	0.07	0.386	0.007	0.075	0.003
P10A	9.8	0.17	2.4	0.07	0.386	0.007	0.094	0.003

廠家：德國歐博斯

生產材料：材料物性表中所有膠種，包含聚氨酯，鐵氟龍材料

生產尺寸：內徑3000mm以下任何規格

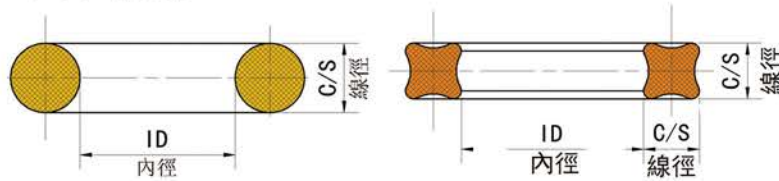

JIS B 2401	ID	+/-	CS	+/-	ID	+/-	CS	+/-
P11	10.8	0.18	2.4	0.07	0.425	0.007	0.094	0.003
P11.2	11	0.18	2.4	0.07	0.433	0.007	0.094	0.003
P12	11.8	0.19	2.4	0.07	0.465	0.007	0.094	0.003
P12.5	12.3	0.19	2.4	0.07	0.484	0.007	0.094	0.003
P14	13.8	0.19	2.4	0.07	0.543	0.007	0.094	0.003
P15	14.8	0.2	2.4	0.07	0.583	0.008	0.094	0.003
P16	15.8	0.2	2.4	0.07	0.622	0.008	0.094	0.003
P18	17.8	0.21	2.4	0.07	0.701	0.008	0.094	0.003
P20	19.8	0.22	2.4	0.07	0.78	0.009	0.094	0.003
P21	20.8	0.23	2.4	0.07	0.819	0.009	0.094	0.003
P22	21.8	0.24	2.4	0.07	0.858	0.009	0.094	0.003
P22A	21.7	0.24	3.5	0.1	0.854	0.009	0.138	0.004
P22.4	22.1	0.24	3.5	0.1	0.87	0.009	0.138	0.004
P24	23.7	0.24	3.5	0.1	0.933	0.009	0.138	0.004
P25	24.7	0.25	3.5	0.1	0.972	0.01	0.138	0.004
P25.5	25.2	0.25	3.5	0.1	0.992	0.01	0.138	0.004
P26	25.7	0.26	3.5	0.1	1.012	0.01	0.138	0.004
P28	27.7	0.28	3.5	0.1	1.091	0.011	0.138	0.004
P29	28.7	0.29	3.5	0.1	1.13	0.011	0.138	0.004
P29.5	29.2	0.29	3.5	0.1	1.15	0.011	0.138	0.004
P30	29.7	0.29	3.5	0.1	1.169	0.011	0.138	0.004
P31	30.7	0.3	3.5	0.1	1.209	0.012	0.138	0.004
P31.5	31.2	0.31	3.5	0.1	1.228	0.012	0.138	0.004
P32	31.7	0.31	3.5	0.1	1.248	0.012	0.138	0.004
P34	33.7	0.33	3.5	0.1	1.327	0.013	0.138	0.004
P35	34.7	0.34	3.5	0.1	1.366	0.013	0.138	0.004
P35.5	35.2	0.34	3.5	0.1	1.386	0.013	0.138	0.004
P36	35.7	0.34	3.5	0.1	1.406	0.013	0.138	0.004
P38	37.7	0.37	3.5	0.1	1.484	0.015	0.138	0.004
P39	38.7	0.37	3.5	0.1	1.524	0.015	0.138	0.004

廠家：德國歐博斯

生產材料：材料物性表中所有膠種，包含聚氨酯，鐵氟龍材料

生產尺寸：內徑3000mm以下任何規格

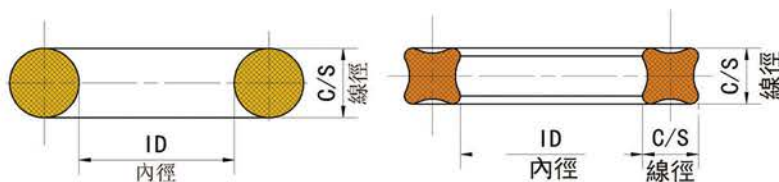

JIS B 2401	ID	+/-	CS	+/-	ID	+/-	CS	+/-
P40	39.7	0.37	3.5	0.1	1.563	0.015	0.138	0.004
P41	40.7	0.38	3.5	0.1	1.602	0.015	0.138	0.004
P42	41.7	0.39	3.5	0.1	1.642	0.015	0.138	0.004
P44	43.7	0.41	3.5	0.1	1.72	0.016	0.138	0.004
P45	44.7	0.41	3.5	0.1	1.76	0.016	0.138	0.004
P46	45.7	0.42	3.5	0.1	1.799	0.017	0.138	0.004
P48	47.7	0.44	3.5	0.1	1.878	0.017	0.138	0.004
P49	48.7	0.45	3.5	0.1	1.917	0.018	0.138	0.004
P50	49.7	0.45	3.5	0.1	1.957	0.018	0.138	0.004
P48A	47.6	0.44	5.7	0.13	1.874	0.017	0.224	0.005
P50A	49.6	0.45	5.7	0.13	1.953	0.018	0.224	0.005
P52	51.6	0.47	5.7	0.13	2.031	0.019	0.224	0.005
P53	52.6	0.48	5.7	0.13	2.071	0.019	0.224	0.005
P55	54.6	0.49	5.7	0.13	2.15	0.019	0.224	0.005
P56	55.6	0.5	5.7	0.13	2.189	0.019	0.224	0.005
P58	57.6	0.52	5.7	0.13	2.268	0.019	0.224	0.005
P60	59.6	0.53	5.7	0.13	2.346	0.021	0.224	0.005
P62	61.6	0.55	5.7	0.13	2.425	0.022	0.224	0.005
P63	62.6	0.56	5.7	0.13	2.465	0.022	0.224	0.005
P65	64.6	0.57	5.7	0.13	2.543	0.022	0.224	0.005
P67	66.6	0.59	5.7	0.13	2.622	0.023	0.224	0.005
P70	69.6	0.61	5.7	0.13	2.74	0.024	0.224	0.005
P71	70.6	0.62	5.7	0.13	2.78	0.024	0.224	0.005
P75	74.6	0.65	5.7	0.13	2.937	0.026	0.224	0.005
P80	79.6	0.69	5.7	0.13	3.134	0.027	0.224	0.005
P85	84.6	0.73	5.7	0.13	3.331	0.029	0.224	0.005
P90	89.6	0.77	5.7	0.13	3.528	0.03	0.224	0.005
P95	94.6	0.81	5.7	0.13	3.724	0.032	0.224	0.005
P100	99.6	0.84	5.7	0.13	3.921	0.033	0.224	0.005
P102	101.6	0.85	5.7	0.13	4	0.033	0.224	0.005

廠家：德國歐博斯

生產材料：材料物性表中所有膠種，包含聚氨酯，鐵氟龍材料

生產尺寸：內徑3000mm以下任何規格

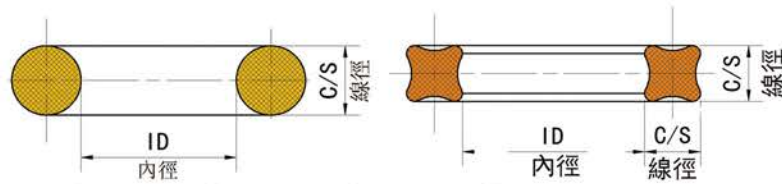

JIS B 2401	ID	+/-	CS	+/-	ID	+/-	CS	+/-
P105	104.6	0.87	5.7	0.13	4.118	0.034	0.224	0.005
P110	109.6	0.91	5.7	0.13	4.315	0.036	0.224	0.005
P112	111.6	0.92	5.7	0.13	4.394	0.036	0.224	0.005
P115	114.6	0.94	5.7	0.13	4.512	0.037	0.224	0.005
P120	119.6	0.98	5.7	0.13	4.709	0.039	0.224	0.005
P125	124.6	1.01	5.7	0.13	4.906	0.04	0.224	0.005
P130	129.6	1.05	5.7	0.13	5.102	0.041	0.224	0.005
P132	131.6	1.06	5.7	0.13	5.181	0.042	0.224	0.005
P135	134.6	1.09	5.7	0.13	5.299	0.043	0.224	0.005
P140	139.6	1.12	5.7	0.13	5.496	0.044	0.224	0.005
P145	144.6	1.16	5.7	0.13	5.693	0.046	0.224	0.005
P150	149.6	1.19	5.7	0.13	5.89	0.047	0.224	0.005
P150A	149.5	1.19	8.4	0.15	5.886	0.047	0.331	0.006
P155	154.5	1.23	8.4	0.15	6.083	0.048	0.331	0.006
P160	159.5	1.26	8.4	0.15	6.28	0.05	0.331	0.006
P165	164.5	1.3	8.4	0.15	6.476	0.051	0.331	0.006
P170	169.5	1.33	8.4	0.15	6.673	0.052	0.331	0.006
P175	174.5	1.37	8.4	0.15	6.87	0.054	0.331	0.006
P180	179.5	1.4	8.4	0.15	7.067	0.055	0.331	0.006
P185	184.5	1.44	8.4	0.15	7.264	0.057	0.331	0.006
P190	189.5	1.48	8.4	0.15	7.461	0.058	0.331	0.006
P195	194.5	1.51	8.4	0.15	7.657	0.059	0.331	0.006
P200	199.5	1.55	8.4	0.15	7.854	0.061	0.331	0.006
P205	204.5	1.58	8.4	0.15	8.051	0.062	0.331	0.006
P209	208.5	1.61	8.4	0.15	8.209	0.063	0.331	0.006
P210	209.5	1.62	8.4	0.15	8.248	0.064	0.331	0.006
P215	214.5	1.65	8.4	0.15	8.445	0.065	0.331	0.006
P220	219.5	1.68	8.4	0.15	8.642	0.066	0.331	0.006
P225	224.5	1.71	8.4	0.15	8.839	0.067	0.331	0.006
P230	229.5	1.75	8.4	0.15	9.035	0.069	0.331	0.006

廠家：德國歐博斯

生產材料：材料物性表中所有膠種，包含聚氨酯，鐵氟龍材料

生產尺寸：內徑3000mm以下任何規格

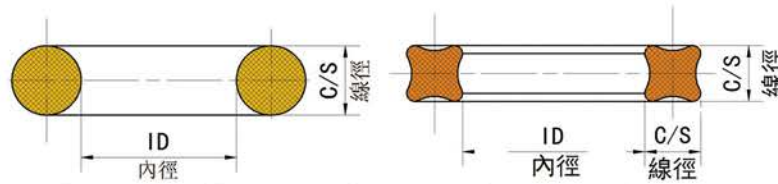

JIS B 2401	ID	+/-	CS	+/-	ID	+/-	CS	+/-
P235	234.5	1.78	8.4	0.15	9.232	0.07	0.331	0.006
P240	239.5	1.81	8.4	0.15	9.429	0.071	0.331	0.006
P245	244.5	1.84	8.4	0.15	9.626	0.072	0.331	0.006
P250	249.5	1.88	8.4	0.15	9.823	0.074	0.331	0.006
P255	254.5	1.91	8.4	0.15	10.02	0.075	0.331	0.006
P260	259.5	1.94	8.4	0.15	10.217	0.076	0.331	0.006
P265	264.5	1.97	8.4	0.15	10.413	0.078	0.331	0.006
P270	269.5	2.01	8.4	0.15	10.61	0.079	0.331	0.006
P275	274.5	2.04	8.4	0.15	10.807	0.08	0.331	0.006
P280	279.5	2.07	8.4	0.15	11.004	0.081	0.331	0.006
P285	284.5	2.1	8.4	0.15	11.201	0.083	0.331	0.006
P290	289.5	2.14	8.4	0.15	11.398	0.084	0.331	0.006
P295	294.5	2.17	8.4	0.15	11.594	0.085	0.331	0.006
P300	299.5	2.2	8.4	0.15	11.791	0.087	0.331	0.006
P305	304.5	2.24	8.4	0.15	11.988	0.088	0.331	0.006
P310	309.5	2.27	8.4	0.15	12.185	0.089	0.331	0.006
P315	314.5	2.3	8.4	0.15	12.382	0.091	0.331	0.006
P320	319.5	2.33	8.4	0.15	12.579	0.092	0.331	0.006
P325	324.5	2.36	8.4	0.15	12.776	0.093	0.331	0.006
P330	329.5	2.39	8.4	0.15	12.972	0.094	0.331	0.006
P335	334.5	2.42	8.4	0.15	13.169	0.095	0.331	0.006
P340	339.5	2.45	8.4	0.15	13.366	0.096	0.331	0.006
P345	344.5	2.48	8.4	0.15	13.563	0.098	0.331	0.006
P350	349.5	2.51	8.4	0.15	13.76	0.099	0.331	0.006
P355	354.5	2.54	8.4	0.15	13.957	0.1	0.331	0.006
P360	359.5	2.57	8.4	0.15	14.154	0.101	0.331	0.006
P365	364.5	2.6	8.4	0.15	14.35	0.102	0.331	0.006
P370	369.5	2.63	8.4	0.15	14.547	0.104	0.331	0.006
P375	374.5	2.67	8.4	0.15	14.744	0.105	0.331	0.006
P380	379.5	2.7	8.4	0.15	14.941	0.106	0.331	0.006

廠家：德國歐博斯

生產材料：材料物性表中所有膠種，包含聚氨酯，鐵氟龍材料

生產尺寸：內徑3000mm以下任何規格

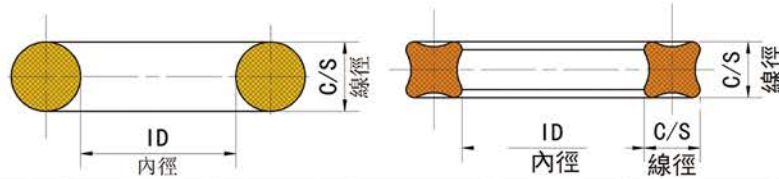

JIS B 2401	ID	+/-	CS	+/-	ID	+/-	CS	+/-
P385	384.5	2.73	8.4	0.15	15.138	0.107	0.331	0.006
P390	389.5	2.77	8.4	0.15	15.335	0.109	0.331	0.006
P395	394.5	2.79	8.4	0.15	15.531	0.11	0.331	0.006
P400	399.5	2.82	8.4	0.15	15.728	0.111	0.331	0.006
P405	404.5	3	8.4	0.15	15.925	0.118	0.331	0.006
P410	409.5	3	8.4	0.15	16.122	0.118	0.331	0.006
P415	414.5	3	8.4	0.15	16.319	0.118	0.331	0.006
P420	419.5	3	8.4	0.15	16.516	0.118	0.331	0.006
P425	424.5	3	8.4	0.15	16.713	0.118	0.331	0.006
P430	429.5	3	8.4	0.15	16.909	0.118	0.331	0.006
P435	434.5	3	8.4	0.15	17.106	0.118	0.331	0.006
P440	439.5	3	8.4	0.15	17.303	0.118	0.331	0.006
P445	444.5	3	8.4	0.15	17.5	0.118	0.331	0.006
P450	449.5	3	8.4	0.15	17.697	0.118	0.331	0.006
P455	454.5	3.3	8.4	0.15	17.894	0.13	0.331	0.006
P460	459.5	3.3	8.4	0.15	18.091	0.13	0.331	0.006
P465	464.5	3.3	8.4	0.15	18.287	0.13	0.331	0.006
P470	469.5	3.3	8.4	0.15	18.484	0.13	0.331	0.006
P475	474.5	3.3	8.4	0.15	18.681	0.13	0.331	0.006
P480	479.5	3.3	8.4	0.15	18.878	0.13	0.331	0.006
P485	484.5	3.3	8.4	0.15	19.075	0.13	0.331	0.006
P490	489.5	3.3	8.4	0.15	19.272	0.13	0.331	0.006
P495	494.5	3.3	8.4	0.15	19.468	0.13	0.331	0.006
P500	499.5	3.3	8.4	0.15	19.665	0.13	0.331	0.006
P590	589.5	3.97	8.4	0.15	23.209	0.156	0.331	0.006
P600	599.5	4.03	8.4	0.15	23.602	0.159	0.331	0.006
P610	609.5	4.09	8.4	0.15	23.996	0.161	0.331	0.006
P620	619.5	4.15	8.4	0.15	24.39	0.163	0.331	0.006
P625	624.5	4.18	8.4	0.15	24.587	0.165	0.331	0.006
P635	634.5	4.25	8.4	0.15	24.98	0.167	0.331	0.006

廠家：德國歐博斯

生產材料：材料物性表中所有膠種，包含聚氨酯，鐵氟龍材料

生產尺寸：內徑3000mm以下任何規格

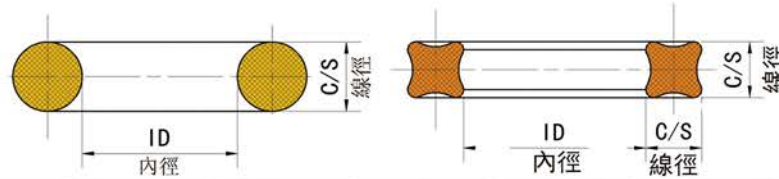

JIS B 2401	ID	+/-	CS	+/-	ID	+/-	CS	+/-
P650	649.5	4.34	8.4	0.15	25.571	0.171	0.331	0.006
P680	679.5	4.52	8.4	0.15	26.752	0.178	0.331	0.006
P690	689.5	4.59	8.4	0.15	27.146	0.181	0.331	0.006
P700	699.5	4.65	8.4	0.15	27.539	0.183	0.331	0.006
P710	709.5	4.71	8.4	0.15	27.933	0.185	0.331	0.006
P720	719.5	4.77	8.4	0.15	28.327	0.188	0.331	0.006
P730	729.5	4.83	8.4	0.15	28.72	0.19	0.331	0.006
P740	739.5	4.89	8.4	0.15	29.114	0.193	0.331	0.006
P750	749.5	4.95	8.4	0.15	29.508	0.195	0.331	0.006
P760	759.5	5.02	8.4	0.15	29.902	0.197	0.331	0.006
P770	769.5	5.08	8.4	0.15	30.295	0.2	0.331	0.006
P780	779.5	5.14	8.4	0.15	30.689	0.202	0.331	0.006
P790	789.5	5.2	8.4	0.15	31.083	0.205	0.331	0.006
P800	799.5	5.26	8.4	0.15	31.476	0.207	0.331	0.006
P810	809.5	5.32	8.4	0.15	31.87	0.21	0.331	0.006
P820	819.5	5.38	8.4	0.15	32.264	0.212	0.331	0.006
P830	829.5	5.44	8.4	0.15	32.657	0.214	0.331	0.006
P840	839.5	5.51	8.4	0.15	33.051	0.217	0.331	0.006
P850	849.5	5.57	8.4	0.15	33.445	0.219	0.331	0.006
P860	859.5	5.63	8.4	0.15	33.839	0.222	0.331	0.006
P870	869.5	5.69	8.4	0.15	34.232	0.224	0.331	0.006
P880	879.5	5.75	8.4	0.15	34.626	0.226	0.331	0.006
P890	889.5	5.81	8.4	0.15	35.02	0.229	0.331	0.006
P900	899.5	5.87	8.4	0.15	35.413	0.231	0.331	0.006
P910	909.5	5.93	8.4	0.15	35.807	0.234	0.331	0.006
P915	914.5	5.96	8.4	0.15	36.004	0.235	0.331	0.006
P920	919.5	5.99	8.4	0.15	36.201	0.236	0.331	0.006
P930	929.5	6.05	8.4	0.15	36.594	0.238	0.331	0.006
P940	939.5	6.11	8.4	0.15	36.988	0.241	0.331	0.006
P950	949.5	6.18	8.4	0.15	37.382	0.243	0.331	0.006

廠家：德國歐博斯

生產材料：材料物性表中所有膠種，包含聚氨酯，鐵氟龍材料

生產尺寸：內徑3000mm以下任何規格

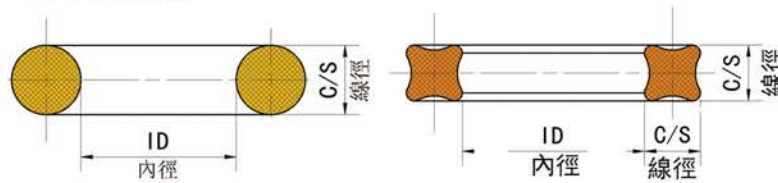

JIS B 2401	ID	+/-	CS	+/-	ID	+/-	CS	+/-
P960	959.5	6.24	8.4	0.15	37.776	0.246	0.331	0.006
P970	969.5	6.3	8.4	0.15	38.169	0.248	0.331	0.006
P980	979.5	6.36	8.4	0.15	38.563	0.25	0.331	0.006
P990	989.5	6.42	8.4	0.15	38.957	0.253	0.331	0.006
P1000	999.5	6.48	8.4	0.15	39.35	0.255	0.331	0.006
JIS B 2401	ID	+/-	CS	+/-	ID	+/-	CS	+/-
S3	2.5	0.13	1.5	0.08	0.098	0.005	0.059	0.003
S4	3.5	0.14	1.5	0.08	0.138	0.006	0.059	0.003
S5	4.5	0.14	1.5	0.08	0.177	0.006	0.059	0.003
S6	5.5	0.15	1.5	0.08	0.217	0.006	0.059	0.003
S7	6.5	0.15	1.5	0.08	0.256	0.006	0.059	0.003
S8	7.5	0.16	1.5	0.08	0.295	0.006	0.059	0.003
S9	8.5	0.16	1.5	0.08	0.335	0.006	0.059	0.003
S10	9.5	0.17	1.5	0.08	0.374	0.007	0.059	0.003
S11.2	10.7	0.18	1.5	0.08	0.421	0.007	0.059	0.003
S12	11.5	0.18	1.5	0.08	0.453	0.007	0.059	0.003
S12.5	12	0.19	1.5	0.08	0.472	0.007	0.059	0.003
S14	13.5	0.19	1.5	0.08	0.531	0.007	0.059	0.003
S15	14.5	0.19	1.5	0.08	0.571	0.007	0.059	0.003
S16	15.5	0.2	1.5	0.08	0.61	0.008	0.059	0.003
S18	17.5	0.21	1.5	0.08	0.689	0.008	0.059	0.003
S20	19.5	0.22	1.5	0.08	0.768	0.009	0.059	0.003
S22	21.5	0.23	1.5	0.08	0.846	0.009	0.059	0.003
S22.4	21.9	0.23	2	0.08	0.862	0.009	0.079	0.003
S24	23.5	0.24	2	0.08	0.925	0.009	0.079	0.003
S25	24.5	0.24	2	0.08	0.965	0.009	0.079	0.003
S26	25.5	0.25	2	0.08	1.004	0.01	0.079	0.003
S28	27.5	0.26	2	0.08	1.083	0.01	0.079	0.003
S29	28.5	0.28	2	0.08	1.122	0.011	0.079	0.003

廠家：德國歐博斯

生產材料：材料物性表中所有膠種，包含聚氨酯，鐵氟龍材料

生產尺寸：內徑3000mm以下任何規格

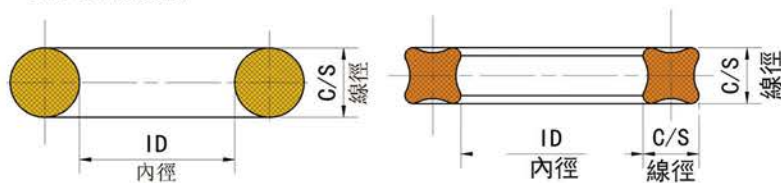

JIS B 2401	ID	+/-	CS	+/-	ID	+/-	CS	+/-
S30	29.5	0.28	2	0.08	1.161	0.011	0.079	0.003
S31.5	31	0.29	2	0.08	1.22	0.011	0.079	0.003
S32	31.5	0.31	2	0.08	1.24	0.012	0.079	0.003
S34	33.5	0.32	2	0.08	1.319	0.013	0.079	0.003
S35	34.5	0.33	2	0.08	1.358	0.013	0.079	0.003
S35.5	35	0.33	2	0.08	1.378	0.013	0.079	0.003
S36	35.5	0.34	2	0.08	1.398	0.013	0.079	0.003
S38	37.5	0.36	2	0.08	1.476	0.014	0.079	0.003
S39	38.5	0.36	2	0.08	1.516	0.014	0.079	0.003
S40	39.5	0.38	2	0.08	1.555	0.015	0.079	0.003
S42	41.5	0.39	2	0.08	1.634	0.015	0.079	0.003
S44	43.5	0.4	2	0.08	1.713	0.016	0.079	0.003
S45	44.5	0.41	2	0.08	1.752	0.016	0.079	0.003
S46	45.5	0.42	2	0.08	1.791	0.017	0.079	0.003
S48	47.5	0.44	2	0.08	1.87	0.017	0.079	0.003
S50	49.5	0.45	2	0.08	1.949	0.018	0.079	0.003
S53	52.5	0.47	2	0.08	2.067	0.019	0.079	0.003
S55	54.5	0.5	2	0.08	2.146	0.02	0.079	0.003
S56	55.5	0.5	2	0.08	2.185	0.02	0.079	0.003
S60	59.5	0.52	2	0.08	2.343	0.02	0.079	0.003
S63	62.5	0.55	2	0.08	2.461	0.022	0.079	0.003
S65	64.5	0.56	2	0.08	2.539	0.022	0.079	0.003
S67	66.5	0.58	2	0.08	2.618	0.023	0.079	0.003
S70	69.5	0.61	2	0.08	2.736	0.024	0.079	0.003
S71	70.5	0.61	2	0.08	2.776	0.024	0.079	0.003
S75	74.5	0.64	2	0.08	2.933	0.025	0.079	0.003
S80	79.5	0.67	2	0.08	3.13	0.026	0.079	0.003
S85	84.5	0.71	2	0.08	3.327	0.028	0.079	0.003
S90	89.5	0.75	2	0.08	3.524	0.03	0.079	0.003
S95	94.5	0.79	2	0.08	3.72	0.031	0.079	0.003

廠家：德國歐博斯

生產材料：材料物性表中所有膠種，包含聚氨酯，鐵氟龍材料

生產尺寸：內徑3000mm以下任何規格

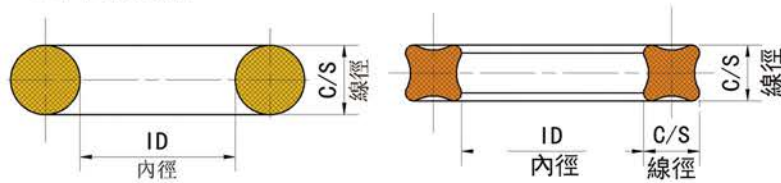

JIS B 2401	ID	+/-	CS	+/-	ID	+/-	CS	+/-
S100	99.5	0.83	2	0.08	3.917	0.033	0.079	0.003
S105	104.5	0.87	2	0.08	4.114	0.034	0.079	0.003
S110	109.5	0.91	2	0.08	4.311	0.036	0.079	0.003
S112	111.5	0.91	2	0.08	4.39	0.036	0.079	0.003
S115	114.5	0.93	2	0.08	4.508	0.037	0.079	0.003
S120	119.5	0.97	2	0.08	4.705	0.038	0.079	0.003
S125	124.5	1	2	0.08	4.902	0.039	0.079	0.003
S130	129.5	1.05	2	0.08	5.098	0.041	0.079	0.003
S132	131.5	1.05	2	0.08	5.177	0.041	0.079	0.003
S135	134.5	1.08	2	0.08	5.295	0.043	0.079	0.003
S140	139.5	1.1	2	0.08	5.492	0.043	0.079	0.003
S145	144.5	1.13	2	0.08	5.689	0.044	0.079	0.003
S150	149.5	1.17	2	0.08	5.886	0.046	0.079	0.003
JIS B 2401	ID	+/-	CS	+/-	ID	+/-	CS	+/-
V10	9.5	0.17	4	0.1	0.374	0.007	0.157	0.004
V15	14.5	0.2	4	0.1	0.571	0.008	0.157	0.004
V24	23.5	0.24	4	0.1	0.925	0.009	0.157	0.004
V34	33.5	0.33	4	0.1	1.319	0.013	0.157	0.004
V40	39.5	0.37	4	0.1	1.555	0.015	0.157	0.004
V55	54.5	0.49	4	0.1	2.146	0.019	0.157	0.004
V58	57.5	0.52	4	0.1	2.264	0.02	0.157	0.004
V70	69	0.61	4	0.1	2.717	0.024	0.157	0.004
V85	84	0.72	4	0.1	3.307	0.028	0.157	0.004
V100	99	0.83	4	0.1	3.898	0.033	0.157	0.004
V120	119	0.97	4	0.1	4.685	0.038	0.157	0.004
V140	138.5	1.08	4	0.1	5.453	0.043	0.157	0.004
V150	148.5	1.18	4	0.1	5.846	0.046	0.157	0.004
V175	173	1.36	4	0.1	6.811	0.054	0.157	0.004
V225	222.5	1.7	6	0.15	8.76	0.067	0.236	0.006

廠家：德國歐博斯

生產材料：材料物性表中所有膠種，包含聚氨酯，鐵氟龍材料

生產尺寸：內徑3000mm以下任何規格

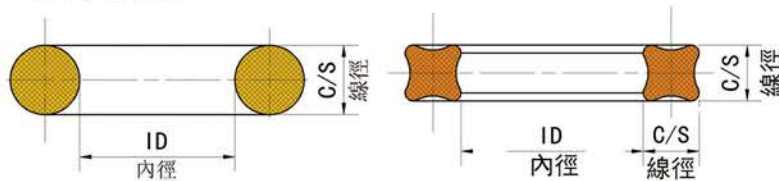

JIS B 2401	ID	+/-	CS	+/-	ID	+/-	CS	+/-
V275	272	2.02	6	0.15	10.709	0.08	0.236	0.006
V315	312	2.22	6	0.15	12.283	0.087	0.236	0.006
V325	321.5	2.34	6	0.15	12.657	0.092	0.236	0.006
V380	376	2.68	6	0.15	14.803	0.106	0.236	0.006
V430	425.5	2.99	6	0.15	16.752	0.118	0.236	0.006
V475	470.5	3.22	6	0.15	18.524	0.127	0.236	0.006
V480	475	3.3	10	0.3	18.701	0.13	0.394	0.012
V490	485	3.31	10	0.3	19.094	0.13	0.394	0.012
V510	504.5	3.44	10	0.3	19.862	0.135	0.394	0.012
V530	524.5	3.6	10	0.3	20.65	0.142	0.394	0.012
V585	579	3.92	10	0.3	22.795	0.154	0.394	0.012
V640	633.5	4.24	10	0.3	24.941	0.167	0.394	0.012
V690	683	4.54	10	0.3	26.89	0.179	0.394	0.012
V740	732.5	4.83	10	0.3	28.839	0.19	0.394	0.012
V790	782	5.12	10	0.3	30.787	0.202	0.394	0.012
V950	940.5	6.06	10	0.3	37.027	0.239	0.394	0.012
V1055	1044	6.67	10	0.3	41.102	0.263	0.394	0.012



骨架油封

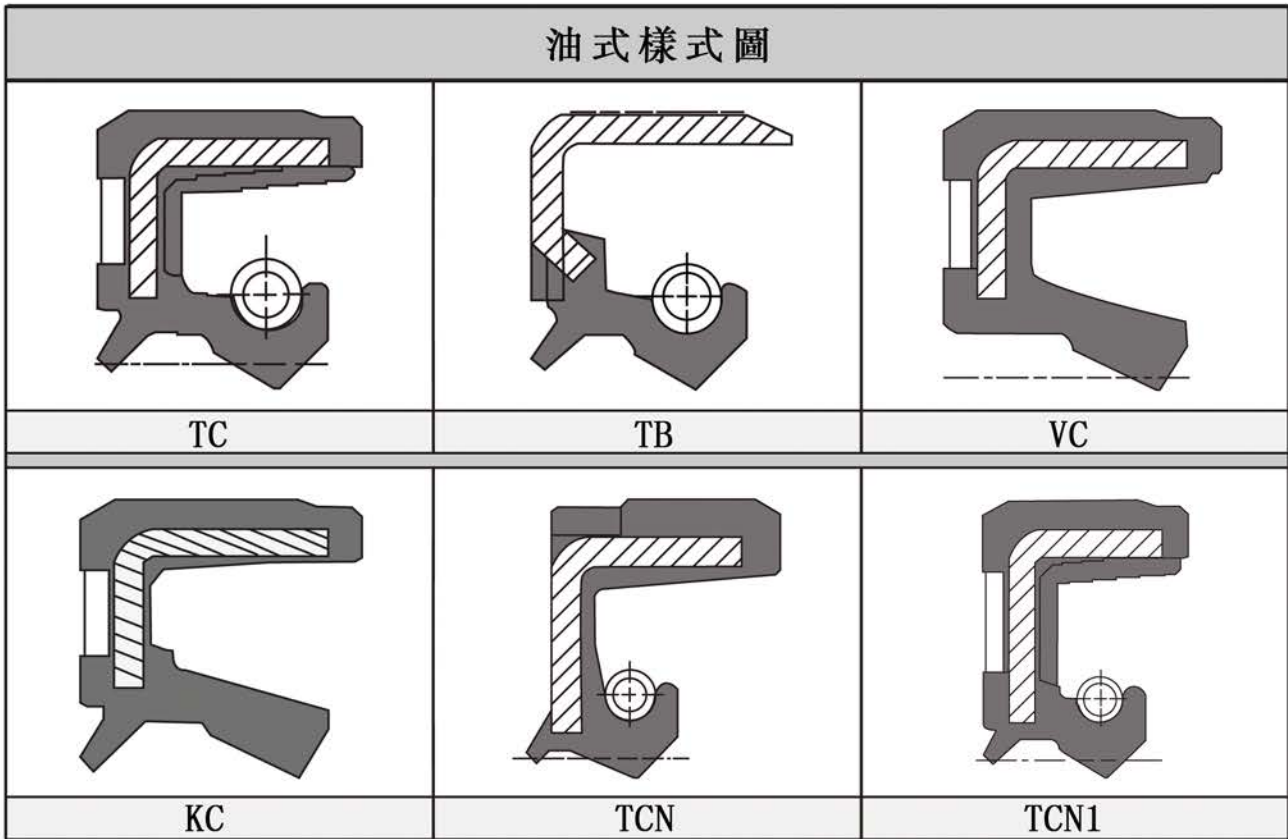

轴径及孔径之 名义尺寸	油封配套孔径之公差 (ISO/R286 H8)	油封配套轴径之公差 (ISO/R286 R11)	油封外径之公差	
			金属外壳	包胶外壳
6.00/10.00	-0.000/+0.020	+0.000/-0.090	+0.07/+0.18	+0.12/+0.27
10.01/18.00	-0.000/+0.027	+0.000/-0.110	+0.07/+0.18	+0.12/+0.27
18.01/30.00	-0.000/+0.033	+0.000/-0.130	+0.08/+0.20	+0.15/+0.30
30.01/50.00	-0.000/+0.039	+0.000/-0.160	+0.08/+0.20	+0.15/+0.30
50.01/80.00	-0.000/+0.046	+0.000/-0.190	+0.09/+0.23	+0.17/+0.32
80.01/120.00	-0.000/+0.054	+0.000/-0.220	+0.10/+0.25	+0.20/+0.35
120.01/180.00	-0.000/+0.063	+0.000/-0.250	+0.11/+0.28	+0.22/+0.40
180.01/250.00	-0.000/+0.072	+0.000/-0.290	+0.13/+0.31	+0.25/+0.45
250.01/315.00	-0.000/+0.081	+0.000/-0.320	+0.15/+0.35	+0.28/+0.50
315.01/400.00	-0.000/+0.089	+0.000/-0.360	+0.18/+0.40	+0.30/+0.55
400.01/500.00	-0.000/+0.097	+0.000/-0.400	+0.20/+0.45	+0.33/+0.60

廠 家：德國歐博斯

生產材料：材料物性表中所有膠種，但不包含聚氨酯（PU）及聚四氟乙烯（PTFE）材料

產品樣式：TC、SC、VC、KC、TB、SB、VB、KB...，亦可依客戶圖面開模生產

生產尺寸：外徑900mm以下之任何規格

ID	OD	H	ID	OD	H	ID	OD	H	ID	OD	H
0.250	0.750	0.250	1.248	1.753	0.248	1.938	2.625	0.375	102	130	13
0.313	0.875	0.250	1.250	1.687	0.250	10	16	4	105	120	7
0.375	0.750	0.250	1.250	1.750	0.250	10	18	4	105	125	12
0.437	0.883	0.250	1.250	1.830	0.375	10	18	6	105	125	13
0.625	1.000	0.250	1.250	1.979	0.406	10	19	4	105	130	12
0.625	1.005	0.250	1.250	2.000	0.250	10	19	7	105	130	13
0.625	1.125	0.250	1.250	2.000	0.500	10	20	4	105	130	14
0.625	1.250	0.250	1.250	2.835	0.375	10	20	5	105	135	12
0.750	1.000	0.250	1.375	1.750	0.250	10	20	6	105	135	14
0.750	1.250	0.250	1.375	1.875	0.313	10	20	7	105	140	12
0.750	1.500	0.276	1.375	2.125	0.375	10	21	5	105	140	14
0.750	1.500	0.313	1.375	2.250	0.375	10	22	5	105	160	12
0.750	1.750	0.313	1.375	2.500	0.375	10	22	6	107	140	13
0.781	1.750	0.250	1.438	2.063	0.313	10	22	7	11	17	4
0.810	1.250	0.250	1.500	1.810	0.118	10	23	7	11	19	6
1.000	1.375	0.250	1.500	1.983	0.250	10	24	7	11	22	7
1.000	1500	0.250	1.500	2.125	0.312	10	25	7	11	23	7
1.000	1.500	0.375	1.500	2.500	0.500	10	26	7	11	24	7
1.000	1.625	0.375	1.531	2.094	0.315	10	28	7	11	26	7
1.000	1.750	0.250	1.535	2.094	0.315	100	120	10	11.6	24	10
1.000	2.000	0.250	1.563	2.500	0.375	100	120	12	11.750	13.250	0.750
1.000	2.000	0.375	1.578	2.125	0.250	100	120	13	110	130	12
1.125	1.500	0.234	1.625	2.250	0.313	100	125	10	110	130	13
1.125	1.500	0.250	1.625	2.375	0.375	100	125	12	110	130	15
1.125	1.562	0.250	1.625	2.500	0.313	100	125	13	110	130	8
1.125	1.563	0.250	1.687	2.561	0.500	100	130	10	110	135	12
1.125	1.563	0.313	1.688	2.625	0.375	100	130	12	110	135	13
1.125	1.625	0.250	1.719	2.561	0.500	100	130	13	110	140	12
1.125	1.625	0.312	1.750	2.313	0.250	100	130	15	110	140	13
1.125	1.625	0.313	1.750	2.375	0.375	100	135	10	110	140	14
1.125	2.000	0.250	1.750	2.438	0.313	100	135	13	110	145	12
1.125	2.000	0.375	1.750	2.500	0.375	100	135	14	110	145	15
1.125	2.441	0.375	1.750	2.500	0.500	100	135	15	110	150	12
1.125	2.835	0.375	1.750	2.718	0.375	100	140	12	110	150	13
1.156	1.498	0.187	1.750	2.906	0.500	100	140	13	110	150	14
1.181	1.654	0.276	1.750	3.000	0.500	100	145	12	110	150	15
1.188	1.750	0.375	1.859	2.500	0.250	100	150	13	110	170	12

廠 家：德國歐博斯

生產材料：材料物性表中所有膠種，但不包含聚氨酯（PU）及聚四氟乙烯（PTFE）材料

產品樣式：TC、SC、VC、KC、TB、SB、VB、KB...，亦可依客戶圖面開模生產

生產尺寸：外徑900mm以下之任何規格

ID	OD	H	ID	OD	H	ID	OD	H	ID	OD	H
110	200	13	12	26	7	13	20	7	14	25	5
110	200	15	12	28	4	13	22	4	14	25	7
115	135	13	12	28	7	13	22	6	14	26	7
115	140	12	12	29	7	13	24	7	14	28	5
115	140	14	12	30	7	13	26	7	14	28	6
115	140	15	12	30	8	13	28	7	14	28	7
115	145	14	12	32	5	13.7	24	5	14	30	10
115	150	12	12	32	7	130	150	12	14	30	7
115	150	13	12	35	7	130	150	13	14	32	7
118	140	12	12	38	7	130	150	14	14	35	7
118	150	12	12	42	8	130	150	15	14	40	7
12	18	4	12.375	13.875	0.750	130	155	14	14.9	24	5
12	18	5	12.9	25	4.5	130	160	12	140	160	12
12	19	5	120	135	10	130	160	13	140	160	13
12	20	4	120	140	12	130	160	14	140	160	14
12	20	5	120	140	13	130	160	15	140	165	13
12	20	6	120	140	14	130	165	14	140	165	15
12	20	7	120	145	12	130	170	12	140	170	12
12	21	4	120	145	14	130	170	13	140	170	13
12	22	4	120	145	15	130	230	14	140	170	14
12	22	5	120	150	12	135	150	15	140	170	15
12	22	6	120	150	13	135	160	15	140	175	13
12	22	7	120	150	14	135	165	12	140	175	15
12	22	9	120	150	15	135	165	13	140	180	12
12	24	10	120	155	15	135	165	14	140	180	14
12	24	5	120	160	12	135	165	15	140	180	16
12	24	6	120	160	13	135	170	12	145	170	12
12	24	7	120	160	15	135	170	15	145	170	13
12	24	8	120	170	16	136	158	12	145	170	15
12	25	10	120	180	15	14	21	7	145	175	14
12	25	4	125	145	12	14	22	4	145	175	15
12	25	5	125	150	12	14	22	5	145	180	12
12	25	6	125	150	13	14	22	7	148	170	15
12	25	7	125	150	14	14	23	6	15	21	4
12	25.5	7	125	150	15	14	24	5	15	22	5
12	26	4.5	125	155	14	14	24	6	15	22	7
12	26	5.5	125	160	12	14	24	7	15	23	7

廠 家：德國歐博斯

生產材料：材料物性表中所有膠種，但不包含聚氨酯（PU）及聚四氟乙烯（PTFE）材料

產品樣式：TC、SC、VC、KC、TB、SB、VB、KB...，亦可依客戶圖面開模生產

生產尺寸：外徑900mm以下之任何規格

ID	OD	H	ID	OD	H	ID	OD	H	ID	OD	H
15	24	7	150	185	15	160	195	15	170	200	18
15	25	4	150	185	16	160	200	15	170	210	15
15	25	5	150	190	13	160	200	16	170	210	16
15	25	6	150	190	15	165	190	13	175	200	15
15	25	7	150	225	12	165	200	15	175	205	15
15	25.5	4.6	155	175	13	17	24	5	18	24	4
15	26	6	155	180	12	17	24	7	18	25	7
15	26	7	155	180	15	17	25	4	18	26	6
15	27	7	155	185	15	17	27	5	18	27	5
15	28	4.5	155	190	15	17	28	5	18	28	6
15	28	6	16	22	4	17	28	6	18	28	7
15	28	7	16	22	7	17	28	7	18	28	8
15	29	7	16	24	4	17	29	7	18	30	10
15	30	10	16	24	5	17	30	10	18	30	6
15	30	5	16	24	6	17	30	5	18	30	7
15	30	6	16	25	5	17	30	6	18	30	8
15	30	7	16	26	7	17	30	7	18	32	7
15	30	8	16	27	7	17	30	8	18	34	7
15	32	7	16	28	7	17	32	5	18	35	10
15	33	7	16	29	7	17	32	7	18	35	5
15	35	10	16	30	10	17	32	8	18	35	7
15	35	4.5	16	30	5	17	34	4	18	35	8
15	35	5	16	30	7	17	34	7	18	38	7
15	35	6	16	32	5	17	35	10	18	40	7
15	35	7	16	32	7	17	35	5	18	40	8
15	35	8	16	35	10	17	35	7	18.9	28	5
15	36	7	16	35	7	17	35	8	18.9	30	5
15	42	8	16	35	9	17	36	7	180	200	13
150	170	12	16	40	7	17	40	10	180	200	15
150	170	14	16	47	8	17	40	5	180	210	10
150	170	15	160	180	10	17	40	7	180	210	15
150	172	12	160	180	13	17	47	10	180	210	16
150	178	12	160	180	15	17	47	7	180	215	15
150	180	12	160	185	15	170	190	13	180	215	16
150	180	13	160	190	13	170	190	8.5	180	220	15
150	180	14	160	190	14	170	200	12	180	220	16
150	180	15	160	190	15	170	200	15	180	220	18

廠 家：德國歐博斯

生產材料：材料物性表中所有膠種，但不包含聚氨酯（PU）及聚四氟乙烯（PTFE）材料

產品樣式：TC、SC、VC、KC、TB、SB、VB、KB...，亦可依客戶圖面開模生產

生產尺寸：外徑900mm以下之任何規格

185	215	16	2.250	3.000	0.375	20	32	6	200	235	16
19	30	5	2.250	3.000	0.500	20	32	7	200	235	18
19	30	6	2.250	3.250	0.500	20	32	8	200	240	18
19	30	7	2.250	3.371	0.375	20	33	6	200	240	20
19	31	5	2.250	3.500	0.500	20	34	7	200	250	15
19	31	6	2.250	3.875	0.375	20	35	10	205	235	16
19	32	7	2.328	2.875	0.313	20	35	4	21	33	7
19	32	8	2.359	3.000	0.438	20	35	5	21	35	7
19	35	5	2.375	3.250	0.375	20	35	6	21	40	7
19	35	7	2.438	3.375	0.500	20	35	7	21	45	7
19	35	8	2.500	3.000	0.375	20	35	8	21	60	10
19	36	7	2.500	3.500	0.370	20	36	7	21.5	35	8
19	38	7	2.500	3.500	0.500	20	37	7	210	240	15
19	40	7	2.500	3.750	0.500	20	37	7.5	210	250	15
19	40	8	2.593	3.250	0.500	20	38	5	210	250	16
19	47	7	2.620	3.750	0.620	20	38	7	210	250	20
19	47	10	2.625	3.250	0.375	20	40	10	215	245	15
19.2	35	6.5	2.625	3.625	0.500	20	40	11	22	30	4
19.8	30	6	2.625	3.750	0.625	20	40	6	22	30	7
190	220	12	2.750	3.750	0.500	20	40	7	22	32	10
190	220	15	2.750	4.000	0.500	20	40	8	22	32	5
190	225	16	2.750	4.000	0.750	20	41	7	22	32	7
190	230	16	2.875	3.750	0.500	20	42	10	22	34	7
195	230	16	2.875	4.000	0.500	20	42	5	22	35	5
2.000	2.625	0.375	2.937	3.875	0.500	20	42	6	22	35	6
2.000	2.750	0.250	20	26	4	20	42	7	22	35	7
2.000	2.750	0.315	20	27	5	20	42	8	22	35	8
2.000	2.750	0.500	20	28	4	20	45	10	22	36	7
2.000	3.000	0.375	20	28	5	20	47	10	22	36	8
2.000	3.000	0.500	20	28	6	20	47	7	22	38	7
2.100	3.000	0.500	20	28	7	20	47	8	22	38	8
2.125	3.000	0.500	20	30	4	20	50	8	22	40	10
2.125	3.250	0.375	20	30	5	20	52	7	22	40	11
2.125	3.372	0.438	20	30	6	20	52	8	22	40	4
2.129	3.370	0.438	20	30	7	20	55	6	22	40	6
2.162	3.544	0.375	20	30	8	20.9	35	7	22	40	7
2.188	3.000	0.375	20	30	9	200	225	15	22	40	8

廠 家：德國歐博斯

生產材料：材料物性表中所有膠種，但不包含聚氨酯（PU）及聚四氟乙烯（PTFE）材料

產品樣式：TC、SC、VC、KC、TB、SB、VB、KB...，亦可依客戶圖面開模生產

生產尺寸：外徑900mm以下之任何規格

ID	OD	H	ID	OD	H	ID	OD	H	ID	OD	H
22	42	11	240	270	15	54	72	8	6	16	7
22	42	7	240	280	15	54	73	8	6	20	6
22	47	7	240	280	16	55	100	10	6	22	7
22	47	8	25	32	5	55	100	12	6.000	6.500	0.250
22	48	7	25	32	6	55	100	13	6.5	14.5	7
22.5	37	7	25	32	7	55	65	7	6.750	7.750	0.500
220	245	16	25	32	8	55	68	8	60	100	10
220	250	15	25	33	4	55	70	10	60	110	10
220	260	14	25	35	10	55	70	7	60	110	7
220	260	16	50	75	8	55	70	8	60	70	10
220	260	22	50	76	12	55	70	9	60	72	8
225	250	16	50	80	10	55	72	10	60	75	10
23	32	7	50	80	12	55	72	12	60	75	8
23	34	6	50	80	13	55	72	8	60	75	9
23	35	6	50	80	8	55	72	9	60	78	10
23	35	7	50	82	12	55	73	10	60	78	9
23	40	6	50	85	10	55	75	10	60	80	10
23	47	10	50	90	10	55	75	12	60	80	12
23	47	7	50	90	12	55	75	8	60	80	13
230	260	15	50	90	8	55	75	9	60	80	7
230	270	16	50.5	62	9	55	76	12	60	80	8
230	270	20	52	100	10	55	78	12	60	82	12
24	32	4	52	62	8	55	80	12	60	82	9
24	35	6	52	63	8	55	85	10	60	85	10
24	35	7	52	65	9	55	88	10	60	85	12
24	35	8	52	68	7	55	90	13	60	85	6
24	36	7	52	68	8	56	70	8	60	85	8
24	37	7	52	72	10	56	72	9	60	88	12
24	40	10	52	72	12	56	85	13	60	90	10
24	40	7	52	72	8	58	100	10	60	90	11
24	40	8	52	75	12	58	72	8	60	90	12
24	42	8	52	75	9	58	75	9	60	90	13
24	47	7	52	85	10	58	80	12	60	90	8
24	48	7	52	90	13	58	80	13	60	95	10
24	49	12	52	90	8	58	80	8	62	100	13
24	50	8	53	65	5	58	82	10	62	120	12
24	52	7	54	68	9	58	85	10	62	75	9

廠 家：德國歐博斯

生產材料：材料物性表中所有膠種，但不包含聚氨酯（PU）及聚四氟乙烯（PTFE）材料

產品樣式：TC、SC、VC、KC、TB、SB、VB、KB...，亦可依客戶圖面開模生產

生產尺寸：外徑900mm以下之任何規格

62	80	9	65	95	10	70	90	7	8	18	5
62	81	10	65	95	12	70	90	8	8	18	7
62	85	10	65	95	13	70	92	10	8	19	7
62	85	12	67	86	9.5	70	92	12	8	20	5
62	90	10	68	110	12	70	95	10	8	21	6
62	90	13	68	80	10	70	95	12	8	22	4
63	100	10	68	82	7	70	95	13	8	22	6
63	75	8	68	90	10	72	100	10	8	22	6.4
63	80	9	68	90	12	72	100	12	8	22	7
63	85	10	7	14	4	72	85	8	8	23	7
63	85	12	7	15	5	72	86	7	8	24	7
63	88	10	7	16	4	72	90	10	8	25	7
63	90	10	7	22	7	75	100	10	80	100	10
63.9	85	12	7.000	8.000	0.500	75	100	12	80	100	12
64	82	8	7.385	8.375	0.500	75	100	13	80	100	13
64	85	12	70	100	10	75	100	7	80	100	7
65	100	10	70	100	12	75	105	10	80	105	10
65	100	8	70	100	13	75	105	12	80	105	12
65	110	10	70	110	10	75	105	13	80	105	13
65	115	10	70	110	12	75	110	12	80	110	10
65	120	12	70	110	13	75	120	12	80	110	12
65	120	13	70	110	8	75	130	13	80	110	13
65	75	8	70	115	12	75	75*85	10	80	115	13
65	80	10	70	120	10	75	90	10	80	115	15
65	80	12	70	120	12	75	90	8	80	120	10
65	80	8	70	125	12	75	92	12	80	120	13
65	80	9	70	130	10	75	95	10	80	125	10
65	82	12	70	130	12	75	95	12	80	125	12
65	85	10	70	80	10	75	95	13	80	125	13
65	85	12	70	85	10	75	95	9	80	125	14
65	85	13	70	85	12	78	100	12	80	130	12
65	85	8	70	85	8	78	100	13	80	135	10
65	88	10	70	85	9	79	110	10	80	140	10
65	88	12	70	88	12	79.3	99	10	80	140	12
65	90	10	70	88	8	79.8	98.4	9.5	80	145	12
65	90	12	70	90	10	8	14	5	80	150	12
65	90	13	70	90	12	8	15	5	80	95	10

廠 家：德國歐博斯

生產材料：材料物性表中所有膠種，但不包含聚氨酯（PU）及聚四氟乙烯（PTFE）材料

產品樣式：TC、SC、VC、KC、TB、SB、VB、KB...，亦可依客戶圖面開模生產

生產尺寸：外徑900mm以下之任何規格

ID	OD	H	ID	OD	H
80	95	9	90	110	12
80	96	9	90	110	13
82	100	10	90	110	8
82	105	12	90	115	10
82	130	10	90	115	11
83	140	13	90	115	12
83	141	13	90	115	13
83	142	13	90	115	9
85	100	10	90	118	12
85	100	12	90	120	10
85	100	13	90	120	12
85	105	10	90	120	13
85	105	12	90	125	12
85	105	13	90	125	13
85	105	8	90	130	12
85	110	10	90	130	13
85	110	12	90	135	12
85	110	13	90	135	13
85	111	10	90	140	12
85	115	12	92	110	8.5
85	120	12	95	110	10
85	120	13	95	110	12
85	125	10	95	115	12
85	125	14	95	115	13
85	130	12	95	120	10
85	135	12.5	95	120	12
85	140	12	95	120	13
85	150	12	95	125	12
85	160	13	95	125	13
86	106	8	95	130	12
9	16	7	95	135	13
9	18	7	95	140	8
9	20	7	95	145	10
9	22	7	95	145	13
90	105	10	95	153	12
90	105	12	95	170	13
90	105	13	98	120	12
			98	130	12

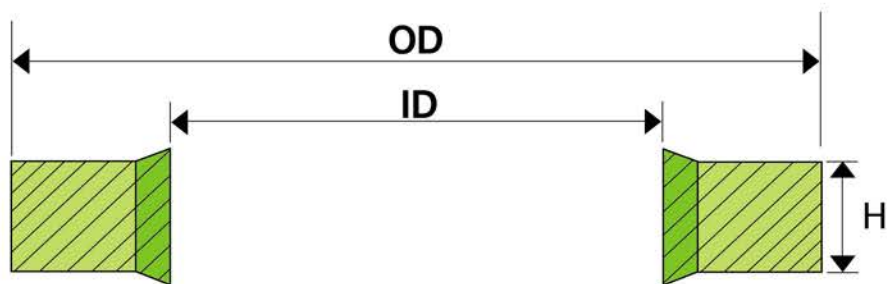

THREAD	DIA'M'	ID	OD	H
INCH	B.S.P	±0.10	+0.13/-0	±0.10
6BA		3.05	6.35	1.2
4BA		4.12	7.26	1.2
2BA		5.21	8.38	1.2
1/4		6.86	13.21	1.2
1/4		6.99	13.34	1.2
5/16		8.31	13.34	1.2
5/16		8.64	14.22	1.2
40		11.26	18.36	2.0
7/16		11.69	19.05	2.0
9/16		14.86	22.23	2.0
		14.86	22.23	2.0
5/8		16.51	25.40	2.0
		16.51	25.40	2.0
11/16		18.16	25.40	2.5
15/16		24.26	33.27	2.5
1+1/8		29.33	36.58	2.5
1+1/4		32.64	41.40	3.2
1+3/8		35.94	44.45	3.2
1+1/2		38.96	47.75	3.2
1+3/4		45.34	57.15	3.2
2		51.69	63.50	3.2
3/8	1/8	10.37	15.88	2.0
1/2	1/4	13.74	20.57	2.0
60		15.83	22.23	2.0
	3/8	17.28	23.80	2.0

THREAD	DIA'M'	ID	OD	H
INCH	B.S.P	±0.10	+0.13/-0	±0.10
3/4		19.69	26.92	2.5
		19.69	26.92	2.5
13/16	1/2	21.54	28.58	2.5
7/8	5/8	23.49	31.75	2.5
1	3/4	27.05	34.93	2.5
1+1/16		27.82	38.61	2.5
1+3/16	7/8	30.81	38.10	2.5
		33.89	42.80	2.5
1+5/16	1	33.89	42.80	3.2
1+5/16	1	33.89	42.80	2.5
		42.93	52.38	2.5
1+5/8	1+1/4	42.93	52.38	3.2
		48.44	58.60	2.5
1+7/8	1+1/2	48.44	58.60	3.2
2+1/8		54.89	69.85	3.2
2+1/4		58.04	70.36	3.2
		60.58	73.03	2.5
	2	60.58	73.03	3.2
2+1/2		64.39	77.72	3.2
	2+1/4	66.68	79.50	3.2
		76.08	90.17	3.2

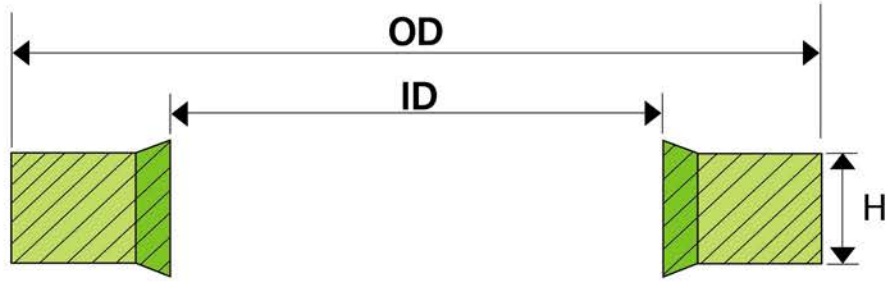

THREAD DIA. 'M'	產品 編號	ID	OD	H	THREAD DIA. 'M'	產品 編號	ID	OD	H
		±0.10	+0.13/-0	±0.10			±0.10	±0.10	±0.10
M3.5	#201	4.1	7.20	1.0	M15	#228	16	22.70	1.5
M4	#202	4.5	7.00	1.0	M16	#229	16.7	24.00	1.5
M5	#203	5.7	9.00	1.0	M17	#230	17.4	24.00	1.5
M5	#204	5.7	10.00	1.0	M17.5	#231	18	24.70	1.5
M5.5	#205	6.2	9.20	1.0	M18	#232	18.7	26.00	1.5
M6	#206	6.7	10.00	1.0	M20	#233	20.7	28.00	1.5
	#206+0.35	6.7	10.00	1.0	M21	#234	21.5	28.70	2.5
M6.5	#209	7.1	12.00	1.0	M22	#235	22.5	28.00	1.5
M6.7	#210	7.3	10.20	1.0	M22	#236	22.7	30.00	2.0
M8	#211	8.5	13.40	1.0	M22	#237	22.7	30.00	3.0
M8	#212	8.7	13.00	1.0	M24	#238	24.7	32.00	2.0
	#212+0.35	8.7	13.00	1.0	M26	#239	26.7	35.00	2.0
M8	#213	8.7	14.00	1.0	M27	#240	27.2	36.00	2.0
M8	#214	8.7	16.00	1.0	M27	#240+0.35	27.2	36.00	2.0
M8.5	#215	9.3	13.30	1.0	M28	#241	28.7	37.00	2.0
M10	#216	10.35	16.00	2.0	M30	#242	31	39.00	2.0
M10	#217	10.7	16.00	1.5	M33	#243	33.7	42.00	2.0
M10	#218	10.7	18.00	1.5	M33	#244	34.3	43.00	2.0
M11	#219	11.4	16.30	1.5	M36	#245	36.7	46.00	2.0
M11	#220	11.8	18.50	1.5	M39	#246	40	51.00	2.5
M11	#221	11.8	19.10	1.5	M42	#247	42.7	53.00	3.0
M12	#222	12.7	18.00	1.5	M48	#248	48.7	59.00	3.0
M12	#222+0.35	12.7	18.00	1.5	M51	#249	52	60.00	3.0
M12	#223	12.7	20.00	1.5	M52	#250	53.3	64.50	3.0
M13	#224	13.7	20.00	1.5	M60	#251	60.7	73.00	3.0
M13	#225	13.7	22.00	1.5					
M13.5	#226	14	18.70	1.5					

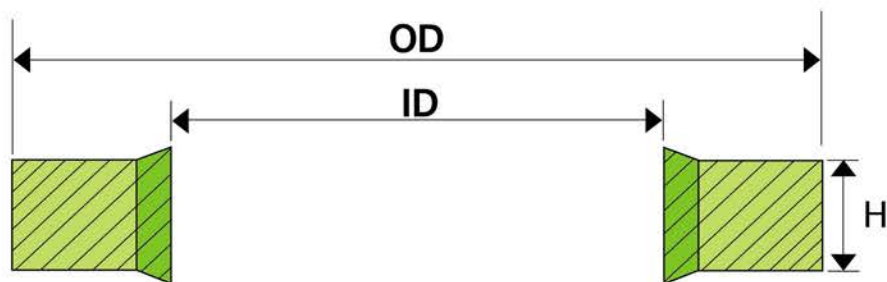

THREAD DIA. 'M'	產品 編號	ID	OD	H
		±0.10	+0.13/-0	±0.10
M3	#301	3.6	7.50	1.0
M4	#302	4.6	9.00	1.0
M5	#303	5.6	10.00	1.0
M6	#304	6.6	11.00	1.0
M6	#305	6.85	13.27	1.3
M6	#306	7	11.40	1.0
M8	#307	8.6	13.00	1.0
M10	#310	10.7	17.00	1.5
M11	#312	11.8	18.10	1.5
M12	#313	12.7	19.00	1.5
M13	#315	13.8	20.10	1.5
M14	#316	14.7	21.00	1.5
M16	#317	16.7	23.00	1.5
M18	#320	18.7	27.00	2.0
M20	#321	20.7	29.00	2.0
M21	#323	21.7	30.00	2.0
M22	#324	22.7	31.00	2.0
M23	#325	23.7	32.00	2.0
M24	#326	24.7	33.00	2.0
M26	#327	27	35.30	2.0
M27	#328	27.7	36.00	2.0
M28	#329	28.6	36.00	2.0
M28.5	#330	29.2	37.50	2.0
M30	#331	30.7	39.00	2.0
M33	#332	33.7	42.00	2.0
M36	#333	37	48.00	2.5
M39	#334	40	51.00	2.5

THREAD DIA. 'M'	產品 編號	ID	OD	H
		±0.10	+0.13/-0	±0.10
M42	#335	43	54.00	2.5
M45	#336	46	57.00	2.5
M48	#337	49	60.00	2.5
THREAD DIA. BSP	產品 編號	ID +0.2	OD -0.2	H ±0.1
1/8	#510	10.4	14.70	1.2
1/4	#511	13.85	18.70	1.2
3/8	#512	17.35	22.70	1.2
1/2	#513	21.65	26.70	1.2
3/4	#514	27.3	32.50	1.2
1	#515	34.2	39.50	2.0
1 1/4	#516	42.8	49.50	2.0
1 1/2	#517	48.7	55.50	2.0
2	#518	60.5	68.50	2.0
1/16	#519	8.3	12.70	1.2

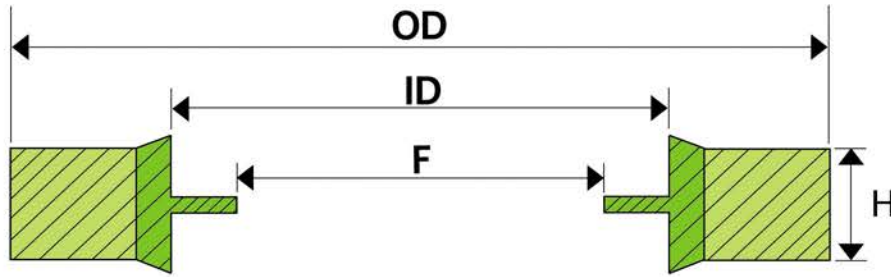

THREAD DIA. 'M'	產品編號	ID ±0.10	OD +0.13/-0	H ±0.10	F ±0.20
M10	#708	10.7	16.08	1.5	8.05
1/8 BSP	#820-A	10.37	15.88	2.0	8.56
	#820-B	10.37	15.88	2.0	8.26
1/4 BSP	#821-A	13.74	20.57	2.0	11.45
	#821-B	13.74	20.57	2.0	11.18
3/8 BSP	#823-A	17.28	23.80	2.0	14.96
	#823-B	17.28	23.80	2.0	14.76
1/2 BSP	#825-A	21.54	28.58	2.5	18.64
	#825-B	21.54	28.58	2.5	18.24
5/8 BSP	#826	23.49	31.75	2.5	20.7
3/4 BSP	#827-A	27.05	34.93	2.5	24.13
	#827-B	27.05	34.93	2.5	23.83
7/8 BSP	#829	30.81	38.10	2.5	27.51
1 BSP	#830-2.5	33.89	42.80	2.5	29.92
	#830-3.2	33.89	42.80	3.2	29.92
1 1/4 BSP	#832-2.5	42.93	52.38	2.5	38.45
	#832-3.2	42.93	52.38	3.2	38.45
1 1/2 BSP	#833-2.5	48.44	58.60	2.5	44.45
	#833-3.2	48.44	58.60	3.2	44.45
1 3/4 BSP	#834	54.89	69.85	3.2	50.42
2 BSP	#836-2.5	60.58	73.03	2.5	56.26
	#836-3.2	60.58	73.03	3.2	56.26
2 1/4 BSP	#838	66.68	79.50	3.2	62.36
2 1/2 BSP	#839	76.08	90.17	3.2	71.5
M6	#865	6.7	11.00	1.0	4.70
M8	#866	8.7	14.00	1.0	6.4
M12	#867	12.7	19.00	1.5	9.73
M14	#868	14.7	22.00	1.5	11.38
5/8	#869	16.51	25.40	2.0	12.9
M16	#870	16.7	24.00	1.5	13.41

THREAD DIA. 'M'	產品編號	ID ±0.10	OD +0.13/-0	H ±0.10	F ±0.20
11/16	#871	18.16	25.40	2.5	14.5
M18	#872	18.7	26.00	1.5	14.76
M20	#873	20.7	28.00	1.5	16.76
M22	#874	22.7	30.00	2.0	18.74
M24	#875	24.7	32.00	2.0	20.11
Thread DIA. "MM"	產品編號	ID ±0.10	OD +0.13/-0	H ±0.10	F ±0.20
M5	203+0.35	5.7	9.0	1.0	4.5
M5	204+0.35	5.7	10.0	1.0	4.5
M6	206+0.35	6.7	10.0	1.0	4.7
M6	207+0.35	6.7	11.0	1.0	4.7
M8	212+0.35	8.7	13.0	1.0	6.4
M8	213+0.35	8.7	14.0	1.0	6.4
M10	216+0.35	10.35	15.88	2.0	8.56
M10	217+0.35	10.7	16.0	1.5	8.05
M10	218+0.35	10.7	18.0	1.5	8.05
M12	222+0.35	12.7	18.0	1.5	9.73
M12	223+0.35	12.7	20.0	1.5	9.73
M14	227+0.35	14.7	22.0	1.5	11.38
M16	229+0.35	16.7	24.0	1.5	13.41
M18	232+0.35	18.7	26.0	1.5	14.76
M20	233+0.35	20.7	28.0	1.5	16.76
M22	236+0.35	22.7	30.0	2.0	18.74
M24	238+0.35	24.7	32.0	2.0	20.11
M26	239+0.35	26.7	35.0	2.0	22.3
M27	240+0.35	27.2	36.0	2.0	23.3
M30	242+0.35	31.0	39.0	2.0	25.7
M32		32.7	40.0	2.0	31.8
M33	243+0.35	33.7	42.0	2.0	28.7
M36	245+0.35	36.7	46.0	2.0	31.1
M42	247+0.35	42.7	53.0	2.0	36.5

NO.	T	A	W
R0004-R0050	1.24	1.14	1.35
R0102-R0178	1.35	1.14	2.18
R0201-R0284	1.27	1.02	3
R0309-R0395	1.93	1.52	4.65
R0425-R0475	2.97	2.44	5.99

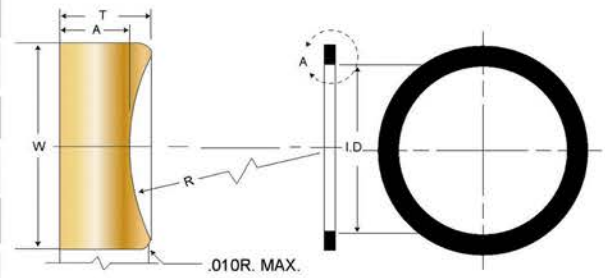

Back-Up Ring SIZE	ID
R0004	2.44
R0005	3.23
R0006	3.56
R0007	4.34
R0008	5.13
R0009	5.94
R0010	6.73
R0011	8.31
R0012	9.91
R0013	11.56
R0014	13.16
R0015	14.73
R0016	16.33
R0017	17.91
R0018	19.51
R0019	21.08
R0020	22.68
R0021	24.26
R0022	25.86
R0023	27.43
R0024	29.03
R0025	30.61
R0026	32.21
R0027	33.78
R0028	35.38
R0029	38.56
R0030	41.73
R0031	44.91
R0032	48.09
R0033	51.26
R0034	54.43
R0035	57.61
R0036	60.78
R0037	63.96
R0038	67.13
R0039	70.31
R0040	73.48

Back-Up RingSIZE	ID
R0042	83.01
R0043	89.36
R0044	95.71
R0045	102.06
R0046	108.41
R0047	114.76
R0048	121.11
R0049	127.46
R0050	133.81
R0102	1.96
R0103	2.77
R0104	3.56
R0105	4.34
R0106	5.13
R0107	5.94
R0108	6.73
R0109	8.31
R0110	9.91
R0111	11.48
R0112	13.08
R0113	14.66
R0114	16.26
R0115	17.83
R0116	19.43
R0117	21.11
R0118	22.68
R0119	24.28
R0120	25.86
R0121	27.46
R0122	29.03
R0123	30.63
R0124	32.21
R0125	33.81
R0126	35.38
R0127	36.98
R0128	38.56
R0129	40.16

Back-Up RingSIZE	ID
R0131	43.33
R0132	44.91
R0133	46.51
R0134	48.08
R0135	49.68
R0136	51.26
R0137	52.86
R0138	54.43
R0139	56.03
R0140	57.61
R0141	59.21
R0142	60.78
R0143	62.38
R0144	63.96
R0145	65.56
R0146	67.13
R0147	68.73
R0148	70.31
R0149	71.91
R0150	73.48
R0151	76.66
R0152	83.01
R0153	89.36
R0154	95.71
R0155	102.06
R0156	108.41
R0157	114.76
R0158	121.11
R0159	127.46
R0160	133.81
R0161	140.16
R0162	146.51
R0163	152.86
R0164	159.21
R0165	165.56
R0166	171.91
R0167	178.26

Back-Up RingSIZE	ID
R0169	190.96
R0170	197.31
R0171	203.66
R0172	210.01
R0173	216.36
R0174	222.71
R0175	229.06
R0176	235.41
R0177	241.76
R0178	248.11
R0201	5.13
R0202	6.73
R0203	8.31
R0204	9.91
R0205	11.56
R0206	13.16
R0207	14.73
R0208	16.33
R0209	17.91
R0210	19.46
R0211	21.03
R0212	22.63
R0213	24.21
R0214	25.81
R0215	27.38
R0216	28.98
R0217	30.56
R0218	32.16
R0219	33.88
R0220	35.48
R0221	37.06
R0222	38.66
R0223	41.83
R0224	45.01
R0225	48.18
R0226	51.36
R0227	54.53

Back-Up RingSIZE	ID
R0229	60.88
R0230	64.06
R0231	66.83
R0232	70
R0233	73.18
R0234	76.35
R0235	79.53
R0236	82.7
R0237	85.88
R0238	89.05
R0239	92.23
R0240	95.4
R0241	98.58
R0242	101.75
R0243	104.93
R0244	108.1
R0245	111.28
R0246	114.45
R0247	117.63
R0248	121.11
R0249	124.28
R0250	127.46
R0251	130.63
R0252	133.81
R0253	136.98
R0254	140.16
R0255	143.33
R0256	146.51
R0257	149.68
R0258	152.86
R0259	159.21
R0260	165.56
R0261	171.91
R0262	178.26
R0263	184.61
R0264	190.96
R0265	197.31

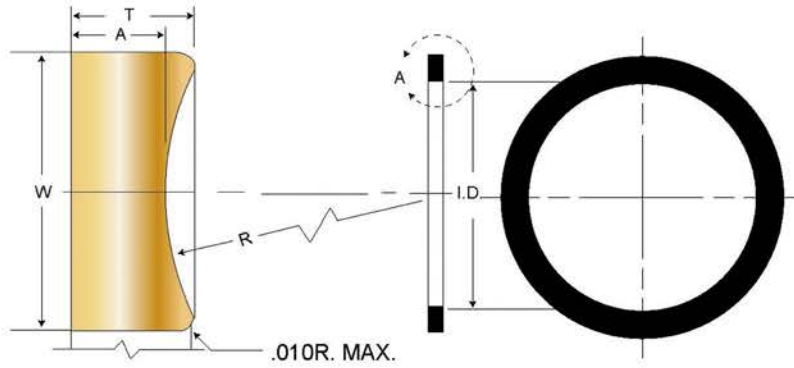

Back-Up RingSIZE	ID	Back-Up RingSIZE	ID	Back-Up RingSIZE	ID	Back-Up RingSIZE	ID	Back-Up RingSIZE	ID
R0266	203.66	R0327	44.78	R0365	178.51	R0431	134.65	R0468	495.4
R0267	210.01	R0328	47.96	R0366	184.86	R0432	137.82	R0469	508.1
R0268	216.36	R0329	51.13	R0367	191.21	R0433	141	R0470	533.5
R0269	222.71	R0330	54.31	R0368	197.56	R0434	144.17	R0471	558.9
R0270	229.06	R0331	57.61	R0369	203.91	R0435	147.35	R0472	584.3
R0271	235.41	R0332	60.78	R0370	210.26	R0436	150.52	R0473	609.7
R0272	241.76	R0333	63.96	R0371	216.61	R0437	153.7	R0474	635.1
R0273	248.11	R0334	67.13	R0372	222.96	R0438	159.36	R0475	660.5
R0274	254.46	R0335	70.31	R0373	229.31	R0439	165.71		
R0275	267.16	R0336	73.48	R0374	235.66	R0440	172.06		
R0276	279.86	R0337	76.66	R0375	242.01	R0441	178.41		
R0277	292.56	R0338	79.83	R0376	248.36	R0442	184.76		
R0278	305.26	R0339	83.13	R0377	254.71	R0443	191.11		
R0279	330.66	R0340	86.31	R0378	267.41	R0444	197.46		
R0280	356.06	R0341	89.48	R0379	280.11	R0445	203.81		
R0281	381.46	R0342	92.66	R0380	292.81	R0446	216.51		
R0282	406.12	R0343	95.83	R0381	305.51	R0447	229.21		
R0283	431.52	R0344	99.01	R0382	330.91	R0448	241.91		
R0284	456.92	R0345	102.31	R0383	356.31	R0449	254.61		
R0309	11.43	R0346	105.49	R0384	381.71	R0450	267.31		
R0310	13.03	R0347	108.66	R0385	406.6	R0451	280.01		
R0311	14.61	R0348	111.84	R0386	432	R0452	292.71		
R0312	16.21	R0349	115.01	R0387	457.4	R0453	305.41		
R0313	17.78	R0350	118.19	R0388	482.75	R0454	318.11		
R0314	19.38	R0351	121.36	R0389	508.15	R0455	330.81		
R0315	20.96	R0352	124.54	R0390	533.55	R0456	343.51		
R0316	22.56	R0353	127.71	R0391	558.95	R0457	356.21		
R0317	24.13	R0354	130.89	R0392	584.02	R0458	368.91		
R0318	25.73	R0355	134.06	R0393	609.42	R0459	381.61		
R0319	27.31	R0356	137.24	R0394	634.82	R0460	394.31		
R0320	28.91	R0357	140.41	R0395	660.22	R0461	406.5		
R0321	30.48	R0358	143.59	R0425	115.6	R0462	419.2		
R0322	32.08	R0359	146.76	R0426	118.77	R0463	431.9		
R0323	33.43	R0360	149.94	R0427	121.95	R0464	444.6		
R0324	35.26	R0361	153.11	R0428	125.12	R0465	457.3		
R0325	38.43	R0362	159.46	R0429	128.3	R0466	470		
R0326	41.61	R0363	165.81	R0430	131.47	R0467	482.7		

管接頭密封圈是符合德國DIN3869標準，專門供端直通液壓管接頭的橡膠密封。管接頭密封圈一次成型，尺寸精確，和端直通液壓管接頭的密封槽配合，密封效果良好。

生產材料：NBR, FKM, EPDM...

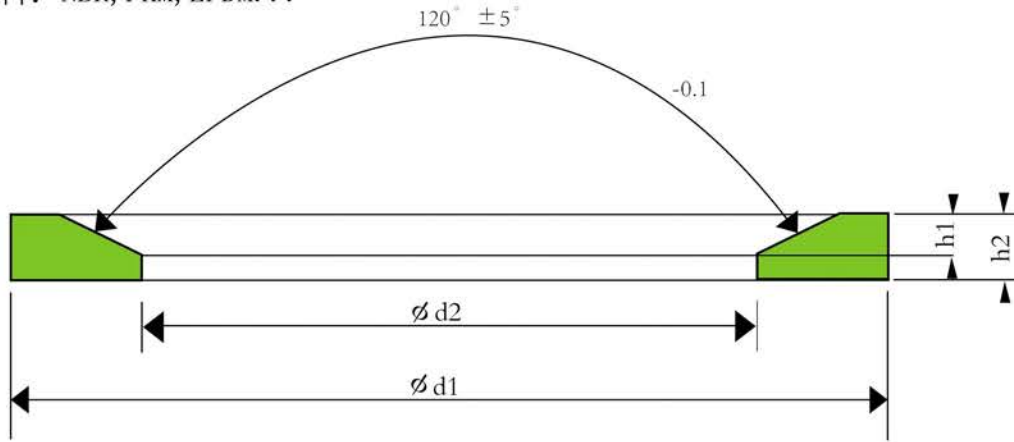

管接頭密封圈規格表

Size	Thread	Thread	d1	d2	h1	h2
8	M8X1	-	6.5	9.9	1.0	0.5
10	M10X1	G1/8A	8.4	11.9	1.0	0.5
12	M12X1.5	-	9.8	14.4	1.5	0.8
14	M14X1.5	G1/4A	11.6	16.5	1.5	0.8
16	M16X1.5	-	13.8	18.9	1.5	0.8
17	-	G3/8A	14.7	18.9	1.5	0.8
18	M18X1.5	-	15.7	20.9	1.5	0.8
20	M20X1.5	-	17.8	22.9	1.5	0.8
21	-	G1/2A	18.5	23.9	1.5	0.8
22	M22X1.5	-	19.6	24.3	1.5	0.8
24	M24X1.5	-	21.6	26.3	1.5	0.8
26	M26X1.5	G3/4A	23.9	29.2	1.5	0.8
27	M27X2.0	G3/4A	23.9	29.2	1.5	0.8
33	M33X2.0	G1A	29.7	35.7	2.0	1.0
42	M42X2.0	G1 1/4A	38.8	45.8	2.0	1.0
48	M48X2.0	G1 1/2A	44.7	50.7	2.0	1.0
60	-	G2A	56.5	66.5	4.0	2.0
75	-	G2 1/2A	72.0	86.0	5.0	2.5

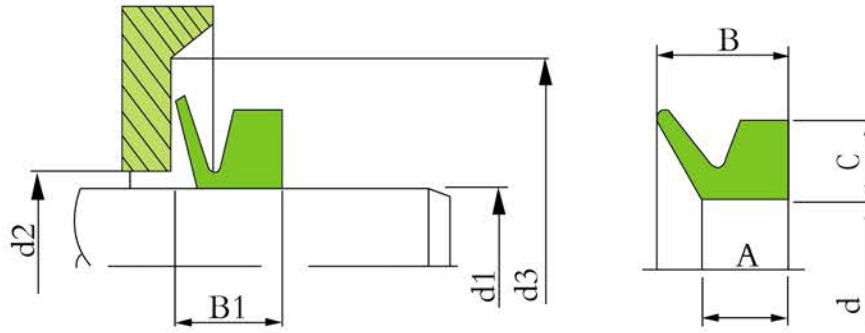

注：當軸徑d1的尺寸在2個V型環的邊界處，請選擇大尺寸的V型環。所有尺寸單位為mm

訂貨號	軸徑尺寸	內徑	截面高度	截面尺寸	截面尺寸	尺寸	尺寸	安裝尺寸
	d1	d	C	A	B	d2	d3	B1
VA-0030	2.7-3.5	2.5	1.5	2.1	3	d1+1	d1+4	2.5±0.3
VA-0040	3.5-4.5	3.2	2	2.4	3.7	d1+1	d1+6	3.0±0.4
VA-0050	4.5-5.5	4	2	2.4	3.7	d1+1	d1+6	3.0±0.4
VA-0060	5.5-6.5	5	2	2.4	3.7	d1+1	d1+6	3.0±0.4
VA-0070	6.5-8.0	6	2	2.4	3.7	d1+1	d1+6	3.0±0.4
VA-0080	8.0-9.5	7	2	2.4	3.7	d1+1	d1+6	3.0±0.4
VA-0100	9.5-11.5	9	3	3.4	5.5	d1+1	d1+9	4.5±0.6
VA-0120	11.5-12.5	10.5	3	3.4	5.5	d1+1	d1+9	4.5±0.6
VA-0130	12.5-13.5	11.7	3	3.4	5.5	d1+1	d1+9	4.5±0.6
VA-0140	13.5-15.5	12.5	3	3.4	5.5	d1+1	d1+9	4.5±0.6
VA-0160	15.5-17	14	3	3.4	5.5	d1+1	d1+9	4.5±0.6
VA-0180	17.5-19	16	3	3.4	5.5	d1+1	d1+9	4.5±0.6
VA-0200	19-21	18	4	4.7	7.5	d1+2	d1+12	6.0±0.8
VA-0220	21-24	20	4	4.7	7.5	d1+2	d1+12	6.0±0.8
VA-0250	24-27	22	4	4.7	7.5	d1+2	d1+12	6.0±0.8
VA-0280	27-29	25	4	4.7	7.5	d1+2	d1+12	6.0±0.8
VA-0300	29-31	27	4	4.7	7.5	d1+2	d1+12	6.0±0.8
VA-0320	31-33	29	4	4.7	7.5	d1+2	d1+12	6.0±0.8
VA-0350	33-36	31	4	4.7	7.5	d1+2	d1+12	6.0±0.8
VA-0380	36-38	34	4	4.7	7.5	d1+2	d1+12	6.0±0.8
VA-0400	38-43	36	5	5.5	9	d1+2	d1+15	7.0±1.0
VA-0450	43-48	40	5	5.5	9	d1+2	d1+15	7.0±1.0
VA-0500	48-53	45	5	5.5	9	d1+2	d1+15	7.0±1.0
VA-0550	53-58	49	5	5.5	9	d1+2	d1+15	7.0±1.0
VA-0600	58-63	54	5	5.5	9	d1+2	d1+15	7.0±1.0
VA-0650	63-68	58	5	5.5	9	d1+2	d1+15	7.0±1.0
VA-0700	68-73	63	6	6.8	11	d1+3	d1+18	9.0±1.2
VA-0750	73-78	67	6	6.8	11	d1+3	d1+18	9.0±1.2

注：大於900mm內徑的VA形水封需要特別定制

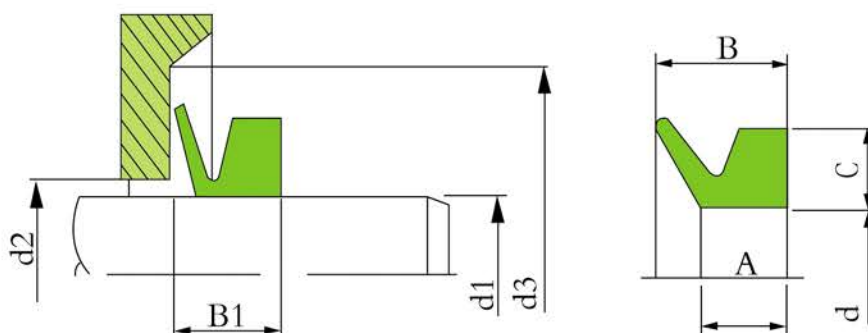

注：當軸徑d1的尺寸在2個V型環的邊界處，請選擇大尺寸的V型環。所有尺寸單位為mm

訂貨號	軸徑尺寸	內徑	截面高度	截面尺寸	截面尺寸	尺寸	尺寸	安裝尺寸
	d1	d	C	A	B	d2	d3	B1
VA-0800	78-83	72	6	6.8	11	d1+3	d1+18	9.0±1.2
VA-0850	83-88	76	6	6.8	11	d1+3	d1+18	9.0±1.2
VA-0900	88-93	81	6	6.8	11	d1+3	d1+18	9.0±1.2
VA-0950	93-98	85	6	6.8	11	d1+3	d1+18	9.0±1.2
VA-1000	98-105	90	6	6.8	11	d1+3	d1+18	9.0±1.2
VA-1100	105-115	99	7	7.9	12.8	d1+4	d1+21	10.5±1.5
VA-1200	115-125	108	7	7.9	12.8	d1+4	d1+21	10.5±1.5
VA-1300	125-135	117	7	7.9	12.8	d1+4	d1+21	10.5±1.5
VA-1400	135-145	126	7	7.9	12.8	d1+4	d1+21	10.5±1.5
VA-1500	145-155	135	7	7.9	12.8	d1+4	d1+21	10.5±1.5
VA-1600	155-165	144	8	9	14.5	d1+4	d1+24	12.0±1.8
VA-1700	165-175	153	8	9	14.5	d1+4	d1+24	12.0±1.8
VA-1800	175-185	162	8	9	14.5	d1+4	d1+24	12.0±1.8
VA-1900	185-195	171	8	9	14.5	d1+4	d1+24	12.0±1.8
VA-1990	195-210	180	8	9	14.5	d1+4	d1+24	12.0±1.8
VA-2000	190-210	180	15	14.3	25	d1+10	d1+45	20.0±4.0
VA-2200	210-235	198	15	14.3	25	d1+10	d1+45	20.0±4.0
VA-2500	235-265	225	15	14.3	25	d1+10	d1+45	20.0±4.0
VA-2750	265-290	247	15	14.3	25	d1+10	d1+45	20.0±4.0
VA-3000	290-310	270	15	14.3	25	d1+10	d1+45	20.0±4.0
VA-3250	310-335	292	15	14.3	25	d1+10	d1+45	20.0±4.0
VA-3500	335-365	315	15	14.3	25	d1+10	d1+45	20.0±4.0
VA-3750	365-390	337	15	14.3	25	d1+10	d1+45	20.0±4.0
VA-4000	390-430	360	15	14.3	25	d1+10	d1+45	20.0±4.0
VA-4500	430-480	405	15	14.3	25	d1+10	d1+45	20.0±4.0
VA-5000	480-530	450	15	14.3	25	d1+10	d1+45	20.0±4.0
VA-5500	530-580	495	15	14.3	25	d1+10	d1+45	20.0±4.0
VA-6000	580-630	540	15	14.3	25	d1+10	d1+45	20.0±4.0

注：大於900mm內徑的VA形水封需要特別定制

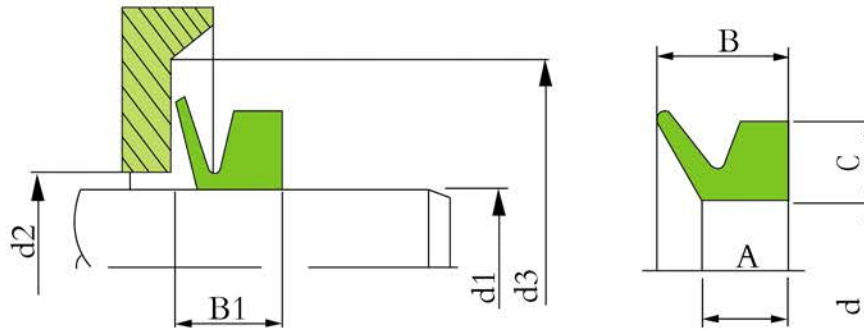

注：當軸徑d1的尺寸在2個V型環的邊界處，請選擇大尺寸的V型環。所有尺寸單位為mm

訂貨號	軸徑尺寸	內徑	截面高度	截面尺寸	截面尺寸	尺寸	尺寸	安裝尺寸
	d1	d	C	A	B	d2	d3	B1
VA-6500	630-665	600	15	14.3	25	d1+10	d1+45	20.0±4.0
VA-7000	665-705	630	15	14.3	25	d1+10	d1+45	20.0±4.0
VA-7250	705-745	670	15	14.3	25	d1+10	d1+45	20.0±4.0
VA-7500	745-785	705	15	14.3	25	d1+10	d1+45	20.0±4.0
VA-8000	785-830	745	15	14.3	25	d1+10	d1+45	20.0±4.0
VA-8500	830-875	785	15	14.3	25	d1+10	d1+45	20.0±4.0
VA-9000	872-920	825	15	14.3	25	d1+10	d1+45	20.0±4.0
VA-9500	920-965	865	15	14.3	25	d1+10	d1+45	20.0±4.0
VA-10000	965-1015	910	15	14.3	25	d1+10	d1+45	20.0±4.0
VA-10500	1015-1065	955	15	14.3	25	d1+10	d1+45	20.0±4.0
VA-11000	1065-1115	1000	15	14.3	25	d1+10	d1+45	20.0±4.0
VA-11500	1115-1165	1045	15	14.3	25	d1+10	d1+45	20.0±4.0
VA-12000	1165-1215	1090	15	14.3	25	d1+10	d1+45	20.0±4.0
VA-12500	1215-1270	1135	15	14.3	25	d1+10	d1+45	20.0±4.0
VA-13000	1270-1320	1180	15	14.3	25	d1+10	d1+45	20.0±4.0
VA-13500	1320-1370	1225	15	14.3	25	d1+10	d1+45	20.0±4.0
VA-14000	1370-1420	1270	15	14.3	25	d1+10	d1+45	20.0±4.0
VA-14500	1420-1470	1315	15	14.3	25	d1+10	d1+45	20.0±4.0
VA-15000	1470-1520	1360	15	14.3	25	d1+10	d1+45	20.0±4.0
VA-15500	1520-1570	1405	15	14.3	25	d1+10	d1+45	20.0±4.0
VA-16000	1570-1620	1450	15	14.3	25	d1+10	d1+45	20.0±4.0
VA-16500	1620-1670	1495	15	14.3	25	d1+10	d1+45	20.0±4.0
VA-17000	1670-1720	1540	15	14.3	25	d1+10	d1+45	20.0±4.0
VA-17500	1720-1770	1585	15	14.3	25	d1+10	d1+45	20.0±4.0
VA-18000	1770-1820	1630	15	14.3	25	d1+10	d1+45	20.0±4.0
VA-18500	1820-1870	1675	15	14.3	25	d1+10	d1+45	20.0±4.0
VA-19000	1870-1920	1720	15	14.3	25	d1+10	d1+45	20.0±4.0
VA-19500	1920-1970	1765	15	14.3	25	d1+10	d1+45	20.0±4.0
VA-20000	1970-2020	1810	15	14.3	25	d1+10	d1+45	20.0±4.0

注：大於900mm內徑的VA形水封需要特別定制

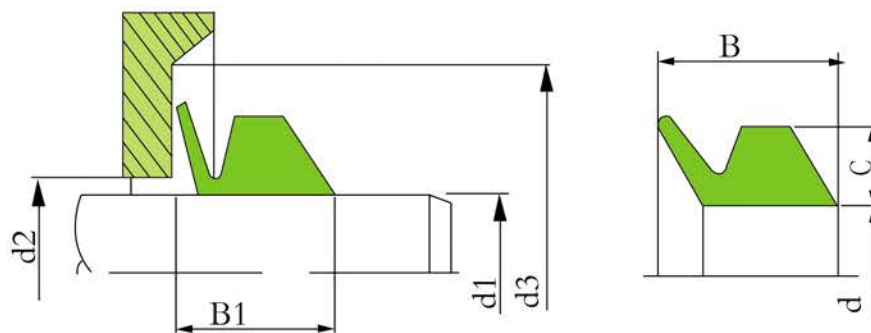

注：當軸徑d1的尺寸在2個V型環的邊界處，請選擇大尺寸的V型環。所有尺寸單位為mm

尺寸表

訂貨號	軸徑尺寸	內徑	截面高度	截面尺寸	截面尺寸	尺寸	尺寸	安裝尺寸
	d1	d	C	A	B	d2	d3	B1
VS-0050	4.5-5.5	4	2	3.9	5.2	d1+1	d1+6	4.5±0.4
VS-0060	5.5-6.5	5						
VS-0070	6.5-8.0	6						
VS-0080	8.0-9.5	7						
VS-0100	9.5-11.5	9	3	5.6	7.7	d1+1	d1+9	6.7±0.6
VS-0120	11.5-13.5	10.5						
VS-0140	13.5-15.5	12.5						
VS-0160	15.5-17.5	14						
VS-0180	17.5-19	16	4	7.9	10.5	d1+2	d1+12	9.0±0.8
VS-0200	19-21	18						
VS-0220	21-24	20						
VS-0250	24-27	22						
VS-0280	27-29	25	5	9.5	13	d1+2	d1+15	11.0±1.0
VS-0300	29-31	27						
VS-0320	31-33	29						
VS-0350	33-36	31						
VS-0380	36-38	34						
VS-0400	38-43	36						
VS-0450	43-48	40						
VS-0500	48-53	45						
VS-0550	53-58	49						
VS-0600	58-63	54						
VS-0650	63-68	58						

注：大於900mm內徑的VS形水封需要特別定制

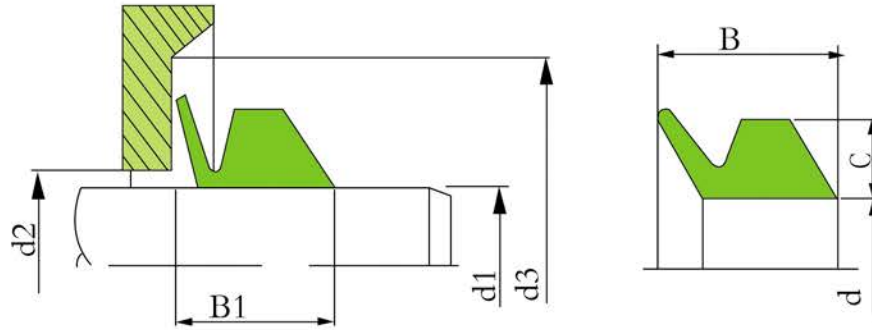

注：當軸徑d1的尺寸在2個V型環的邊界處，請選擇大尺寸的V型環。所有尺寸單位為mm

尺寸表								
訂貨號	軸徑尺寸	內徑	截面高度	截面尺寸	截面尺寸	尺寸	尺寸	安裝尺寸
	d1	d	C	A	B	d2	d3	B1
VS-0700	68-73	63	6	11.3	15.5	d1+3	d1+18	13.5±1.2
VS-0750	73-78	67						
VS-0800	78-83	72						
VS-0850	88-93	76						
VS-0900	93-98	81						
VS-0950	93-98	85						
VS-1000	98-105	90	7	13.1	18	d1+4	d1+21	15.5±1.5
VS-1100	105-115	99						
VS-1200	115-125	108						
VS-1300	125-135	117						
VS-1400	135-145	126						
VS-1500	145-155	135						
VS-1600	155-165	144	8	15	20.5	d1+4	d1+24	18.0±1.8
VS-1700	165-175	153						
VS-1800	175-185	162						
VS-1900	185-195	171						
VS-1990	195-210	180						

注：大於900mm內徑的VS形水封需要特別定制



油 壓

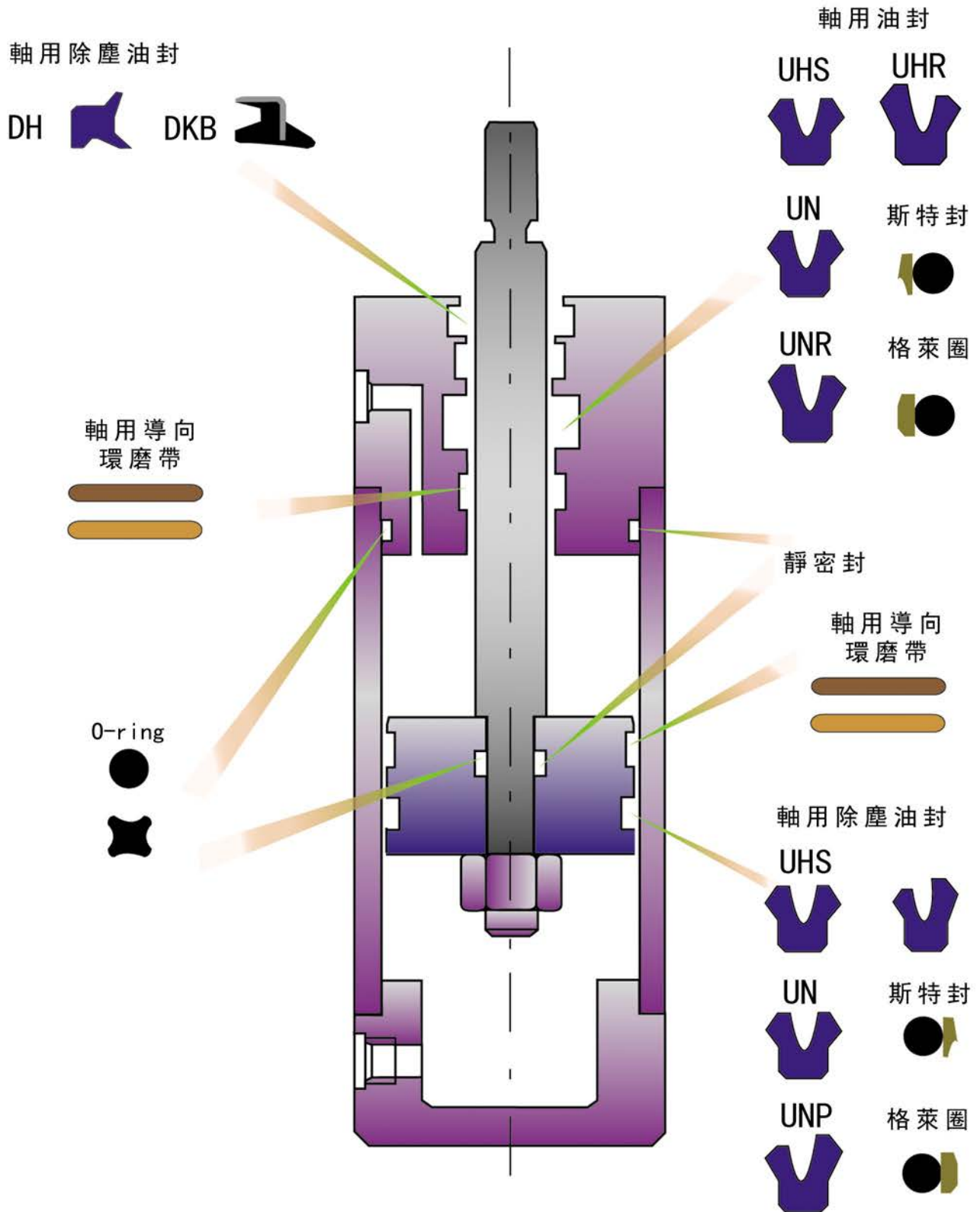

廠 家：德國歐博斯

生產材料：除目錄內規格外，亦可依客戶圖面生產

工作溫度：建議常態工作溫度在80°C以下

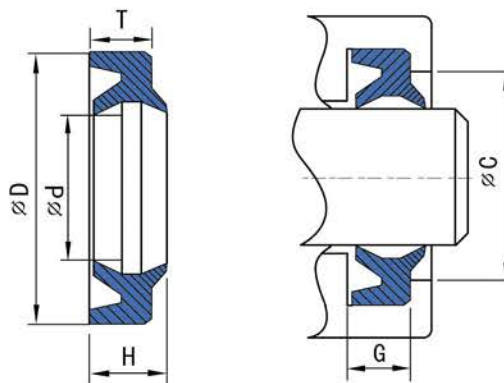

型号 PART No	尺寸 Size(mm)					型号 PART No	尺寸 Size(mm)				
	内径(d) mm	外径(D) mm	高度(T) mm	总高度 (H)mm	G		内径(d) mm	外径(D) mm	高度(T) mm	总高度 (H)mm	G
DHS-11.2	11.2	19.2	4.5	6	5	DHS-95	95	105	6	8	7
DHS-12	12	20	4.5	6	5	DHS-98	98	108	6	8	7
DHS-14	14	22	4.5	6	5	DHS-100	100	110	6	8	7
DHS-16	16	24	4.5	6	5	DHS-110	110	120	6	8	7
DHS-18	18	26	4.5	6	5	DHS-112	112	122	6	8	7
DHS-20	20	28	4.5	6	5	DHS-115	115	125	6	8	7
DHS-22.4	22.4	30.4	4.5	6	5	DHS-118	118	128	6	8	7
DHS22	22	31.3	3.7	7.8	4.2	DHS-120	120	130	7	10	8
DHS22	22	30	4.5	6	5	DHS-125	125	138	7	9.5	8
DHS-23.5	23.5	31.5	4.5	6	5	DHS-130	130	143	7	9.5	8
DHS-25	25	33	4.5	6	5	DHS-136	136	149	7	9.5	8
DHS-28	28	36	4.5	6	5	DHS-140	140	153	7	9.5	8
DHS-30	30	38	5	6.5	6	DHS-145	145	158	7	9.5	8
DHS-31.5	31.5	39.5	5	6.5	6	DHS-150	150	163	7	9.5	8
DHS-32	32	40	5	6.5	6	DHS-160	160	174	7	9.5	8
DHS-35	35	43	5	6.5	6	DHS-165	165	179	7	9.5	8
DHS-35.5	35.5	43.5	5	6.5	6	DHS-180	180	194	7	9.5	8
DHS-38	38	46	5	6.5	6	DHS-190	190	203	7	9.5	8
DHS-40	40	48	5	6.5	6	DHS-200	200	214	7	9.5	8
DHS-45	45	53	5	6.5	6	DHS-204	204	218	7	9.5	8
DHS-50	50	58	5	6.5	6	DHS-205	205	215	7	9.5	8
DHS-52	52	59	5	6.5	6	DHS-230	230	244	7	9.5	8
DHS-53	53	61	5	6.5	6						
DHS-55	55	63	5	6.5	6						
DHS-56	56	64	5	6.5	6						
DHS-60	60	68	5	6.5	6						
DHS-63	63	71	5	6.5	6						
DHS-65	65	73	5	6.5	6						
DHS-67	67	75	5	6.5	6						
DHS-70	70	80	6	8	7						
DHS-71	71	81	6	8	7						
DHS-75	75	85	6	8	7						
DHS-80	80	90	6	8	7						
DHS-85	85	95	6	8	7						
DHS-90	90	100	6	8	7						

廠 家：德國歐博斯

生產材料：除目錄內規格外，亦可依客戶圖面生產

工作溫度：建議常態工作溫度在80°C以下

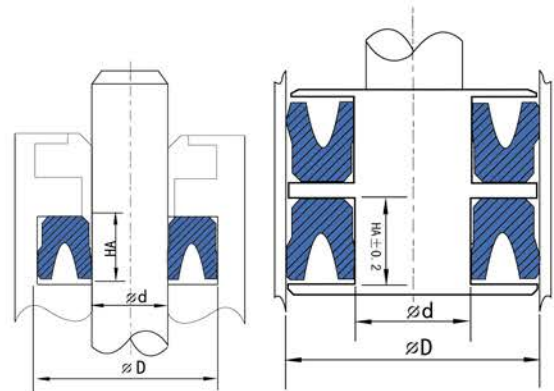
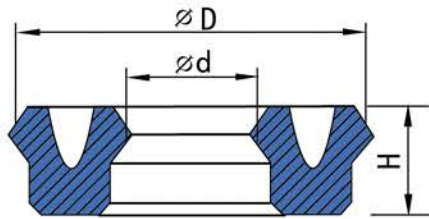

型号 PART No	尺寸 Size(mm)			
	Φd	ΦD	H	G
UPI	4	10	4	4.5
UPI	4	11	5	6
UPI	4	12	4	4.5
UPI	4.5	9.5	4	4.5
UPI	4.5	11	4.5	5
UPI	4.5	11	5	5.5
UPI	5	11	8	9
UPI	5	12	5	6
UPI	5	12	5.5	6.5
UPI	5	12	6	7
UPI	5	12	8	9
UPI	5	14	4.5	5.5
UPI	5	14	6	7
UPI	5	14	8	9
UPI	5	16	6	7
UPI	5	16	8	9
UPI	6	10	4.2	4.5
UPI	6	12	4	4.5
UPI	6	12	5	6
UPI	6	12	5.5	6.5
UPI	6	12	6	7
UPI	6	12	8	9
UPI	6	13	5	6
UPI	6	13	8	9
UPI	6	13.5	5	6
UPI	6	14	5	8
UPI	6	14	6	7
UPI	6	14	8	9
UPI	6	15	6	7
UPI	6	16	6	7
UPI	6	16	8	9
UPI	6.3	16.3	8	9
UPI	7.1	17.1	8	9
UPI	7.93	14.28	3.17	3.5
UPI	8	14	4	5
UPI	8	14	6	7

型号 PART No	尺寸 Size(mm)			
	Φd	ΦD	H	G
UPI	8	14	8	9
UPI	8	15	6	7
UPI	8	15	8	9
UPI	8	16	4	5
UPI	8	16	5.7	6.3
UPI	8	16	6	7
UPI	8	16	8	9
UPI	8	18	8	9
UPI	8	19	8	9
UPI	8	22	10	11
UPI	9	16	6	7
UPI	9	19	6	7
UPI	9	19	8	9
UPI	10	14	2.5	3
UPI	10	14	4	5
UPI	10	15	3	4
UPI	10	16	4	5
UPI	10	16	4.5	5.5
UPI	10	16	6	7
UPI	10	16	8	9
UPI	10	18	5	6
UPI	10	18	5.5	6.5
UPI	10	18	6	7
UPI	10	18	8	9
UPI	10	20	5	6
UPI	10	20	6	7
UPI	10	20	7	8
UPI	10	20	8	9
UPI	10	22	6	7
UPI	10	22	8	9
UPI	11	17	4	5
UPI	11	17	4.5	5.5
UPI	11.11	19.05	4.76	5.25
UPI	11.2	19.2	5	6
UPI	11.2	21.2	8	9
UPI	12	18	4	5

廠 家：德國歐博斯

生產材料：除目錄內規格外，亦可依客戶圖面生產

工作溫度：建議常態工作溫度在80°C以下

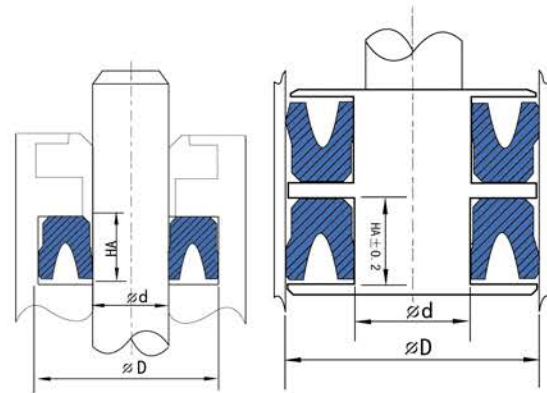
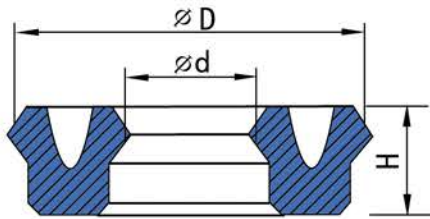

型号 PART No	尺寸 Size(mm)			
	Φd	ΦD	H	G
UPI	12	18	4.5	5.5
UPI	12	18	5	6
UPI	12	18	6	7
UPI	12	18	6	7
UPI	12	18	8	9
UPI	12	19	5	6
UPI	12	20	4	5
UPI	12	20	5	6
UPI	12	20	6	7
UPI	12	20	7	8
UPI	12	20	8	9
UPI	12	22	5	6
UPI	12	22	6	7
UPI	12	22	7	8
UPI	12	22	8	9
UPI	12	24	6	7
UPI	12	24	8	9
UPI	12	25	8	9
UPI	12	25	10	11
UPI	12	26	10	11
UPI	12.5	22.5	8	8
UPI	13	21	5	6
UPI	14	20	5	6
UPI	14	20	6	7
UPI	14	20	8	9
UPI	14	21	5	6
UPI	14	22	4	5
UPI	14	22	5	6
UPI	14	22	6	7
UPI	14	22	8	9
UPI	14	24	5	6
UPI	14	24	8	9
UPI	14	25	5.5	6.5
UPI	14	25	8	9
UPI	14	26	5	6
UPI	14	28	10	11

型号 PART No	尺寸 Size(mm)			
	Φd	ΦD	H	G
UPI	15	22	5	6
UPI	15	22	6	7
UPI	15	22	8	9
UPI	15	23	5	6
UPI	15	25	5	6
UPI	15	25	6	7
UPI	15	25	7	8
UPI	15	25	8	9
UPI	15	25	10	11
UPI	15	27	7	8
UPI	15	30	8	9
UPI	15	30	10	11
UPI	15.8	20	3	4
UPI	16	22	4	4.5
UPI	16	22	5	6
UPI	16	22	6	7
UPI	16	22	7	8
UPI	16	22	8	9
UPI	16	24	4	5
UPI	16	24	5	6
UPI	16	24	6	7
UPI	16	24	8	9
UPI	16	24	9	10
UPI	16	26	5	6
UPI	16	26	7	8
UPI	16	26	8	9
UPI	16	28	6	7
UPI	16	30	5	6
UPI	16	30	6	7
UPI	16	32	8	9
UPI	16	36	5	6
UPI	17	25	5	6
UPI	17	25	5.5	6.5
UPI	17	25	6	7
UPI	17	30	6	7
UPI	17	30	7	8

廠 家：德國歐博斯

生產材料：除目錄內規格外，亦可依客戶圖面生產

工作溫度：建議常態工作溫度在80°C以下

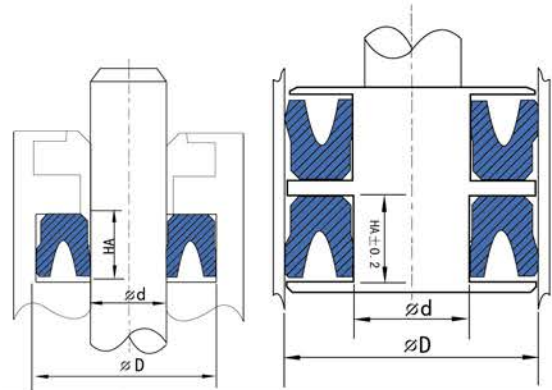
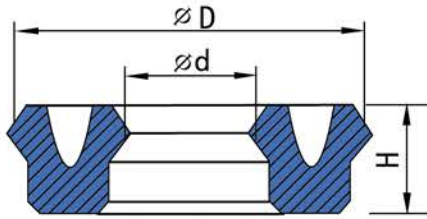

型号 PART No	尺寸 Size(mm)			
	Φd	ΦD	H	G
UPI	18	24	8	9
UPI	18	25	5	6
UPI	18	26	5	6
UPI	18	26	6	7
UPI	18	26	6	8
UPI	18	26	7	9
UPI	18	28	8	6
UPI	18	28	5	9
UPI	18	28	8	7
UPI	18	30	6	9
UPI	18	30	8	9
UPI	18	30	10	11
UPI	18	31	8	9
UPI	18	32	7	8
UPI	18	34	8	9
UPI	18	38	6	7
UPI	18	24	6	7
UPI	18.5	31.74	6.35	7
UPI	19	25	5	6
UPI	19	25	7	8
UPI	19	34	8	9
UPI	19.05	30.16	6.35	7
UPI	19.05	33.34	7.93	8.74
UPI	19.2	26	3.2	4
UPI	20	26	3	4
UPI	20	26	5	6
UPI	20	26	6	7
UPI	20	27	6	7
UPI	20	28	4	5
UPI	20	28	5	6
UPI	20	28	5.5	6.5
UPI	20	28	6	7
UPI	20	28	7	8
UPI	20	28	8	9
UPI	20	30	5	6
UPI	20	30	6	7

型号 PART No	尺寸 Size(mm)			
	Φd	ΦD	H	G
UPI	20	30	7	8
UPI	20	30	8	9
UPI	20	30	10	11
UPI	20	30	8	9
UPI	20	30	6	7
UPI	20	31	8	9
UPI	20	32	8	9
UPI	20	32	10	11
UPI	20	33	12	13
UPI	20	33	7	8
UPI	20	34.5	8	9
UPI	20	35	10	11
UPI	20	35	8	9
UPI	20	35	12	13
UPI	20	36	10	10
UPI	20	37	8	9
UPI	20	38	10	11
UPI	20	40	12	13
UPI	20	40	2.8	3.5
UPI	22	40	4	5
UPI	22	26	4.5	5.5
UPI	19	26	5	6
UPI	18.5	28	8	9
UPI	19	29	5	6
UPI	19	30	4	5
UPI	19	30	5	6
UPI	19.05	30	6	7
UPI	19.05	30	7	8
UPI	20	32	5	6
UPI	20	32	6	7
UPI	20	32	7.2	8
UPI	20	32	8	9
UPI	20	32	10	11
UPI	20	34	7	8
UPI	20	34	10	11
UPI	20	35	6	7

廠 家：德國歐博斯

生產材料：除目錄內規格外，亦可依客戶圖面生產

工作溫度：建議常態工作溫度在80°C以下

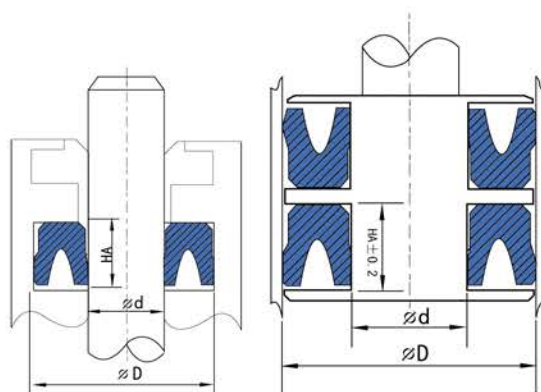
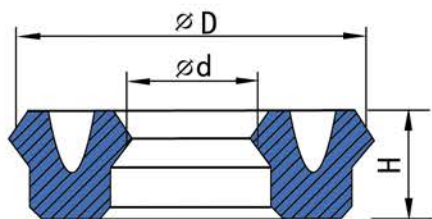

型号 PART No	尺寸 Size(mm)			
	Φd	ΦD	H	G
UPI	20	35	10	11
UPI	20	36	9	10
UPI	20	38	8	9
UPI	20	40	10	11
UPI	20	40	12	13
UPI	20	30	5	6
UPI	20	32.4	8	9
UPI	20	31.5	5	6
UPI	20	33	5.3	6
UPI	20	35	6	7
UPI	20	31.5	5	6
UPI	20	39.69	7.93	8.74
UPI	20	41.28	9.52	10.49
UPI	20	30	6	7
UPI	20	32	4	5
UPI	20	32	5	6
UPI	20	32	6	7
UPI	20	32	7	8
UPI	20	34	5	6
UPI	20	34	6	7
UPI	20	34	7	8
UPI	20	36	6	7
UPI	22	36	8	9
UPI	22	30	6	7
UPI	22	31	6	7
UPI	25	32	4	5
UPI	25	32	5	6
UPI	25	32	7	8
UPI	25	32	8	9
UPI	25	33	5	6
UPI	25	33	5.5	6.5
UPI	25	33	6	7
UPI	25	33	7	8
UPI	25	33	8	9
UPI	25	33	10	11
UPI	25	35	5	6

型号 PART No	尺寸 Size(mm)			
	Φd	ΦD	H	G
UPI	25	35	7.3	8
UPI	25	35	8	9
UPI	25	35	10	11
UPI	25	36	6	7
UPI	25	37	7	8
UPI	25	38	8	9
UPI	25	38	10	11
UPI	25	40	6	7
UPI	25	40	6.5	7.5
UPI	25	40	8	9
UPI	25	40	10	11
UPI	25	42	8	9
UPI	25	43	8	9
UPI	25	45	8	9
UPI	25	45	10	11
UPI	25	50	10	11
UPI	25.4	30.2	6	7
UPI	26	32	4.7	5.5
UPI	26	36	8	9
UPI	26	36	10	11
UPI	26	38	8	9
UPI	26	47	12	13
UPI	27	35	5	6
UPI	27	36	6	7
UPI	28	35	5	6
UPI	28	35	6	7
UPI	28	35.5	5	6
UPI	25	38	7	8
UPI	43	43	6	7
UPI	28	35.5	5	6
UPI	28	36	4	5
UPI	28	36	5	6
UPI	28	36	6	7
UPI	28	36	7	8
UPI	28	38	8	9
UPI	28	38	6	7

廠 家：德國歐博斯

生產材料：除目錄內規格外，亦可依客戶圖面生產

工作溫度：建議常態工作溫度在80°C以下

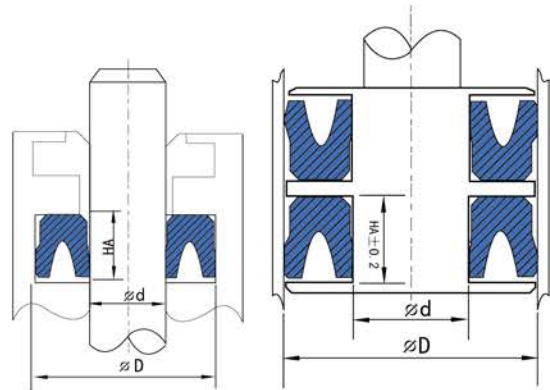
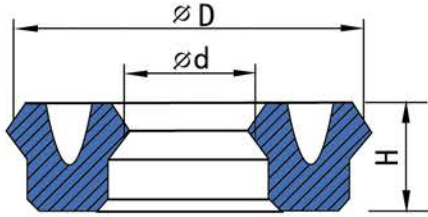

型号 PART No	尺寸 Size(mm)			
	Φd	ΦD	H	G
UPI	28	38	7	8
UPI	28	38	8	9
UPI	28	38	10	11
UPI	28	40	8	9
UPI	28	40	10	11
UPI	28	43	10	11
UPI	28	44	8	9
UPI	28	50	13	14
UPI	30	36	8	9
UPI	30	37	6	7
UPI	30	38	5	6
UPI	30	38	5.7	6.3
UPI	30	38	6	7
UPI	30	38	7	8
UPI	30	38	8	9
UPI	30	40	5	6
UPI	30	40	5.5	6.5
UPI	30	40	6	7
UPI	30	40	6	7
UPI	30	40	6.5	7.5
UPI	30	40	7	8
UPI	30	40	7.3	8
UPI	30	40	8	9
UPI	30	40	10	11
UPI	30	42	6	7
UPI	30	42	8	9
UPI	30	42	9	10
UPI	30	42	10	11
UPI	30	43	6.5	7.5
UPI	30	43.6	9.5	10.5
UPI	30	44	5.5	6.5
UPI	30	45	8	9
UPI	30	45	10	11
UPI	30	46	10	11
UPI	30	43	10	11
UPI	30	42	7	8

型号 PART No	尺寸 Size(mm)			
	Φd	ΦD	H	G
UPI	30	48	10	11
UPI	30	50	8	10
UPI	30	50	10	11
UPI	30	50	11	12
UPI	30	50	12	13
UPI	30	52	10	11
UPI	31	47	10	11
UPI	31.5	41.5	6	7
UPI	31.5	44.3	9.5	10.5
UPI	31.5	46.5	10	11
UPI	31.8	41.3	6.3	7
UPI	32	39	8	9
UPI	32	40	4	5
UPI	32	40	5	6
UPI	32	40	5.5	6.5
UPI	32	40	6	7
UPI	32	40	6.3	7
UPI	32	40	8	9
UPI	32	40	10	11
UPI	32	42	6	7
UPI	32	42	7	8
UPI	32	42	8	9
UPI	32	42	10	11
UPI	32	44	6.3	7.3
UPI	32	45	6	7
UPI	32	45	8	9
UPI	32	45	10	11
UPI	32	46	10	11
UPI	32	47	10	11
UPI	32	48	8	9
UPI	32	48	10	11
UPI	32	50	10	11
UPI	32.5	38	8	9
UPI	33	39	8	9
UPI	33	40	8	9
UPI	33	42	8	9

廠 家：德國歐博斯

生產材料：除目錄內規格外，亦可依客戶圖面生產

工作溫度：建議常態工作溫度在80°C以下

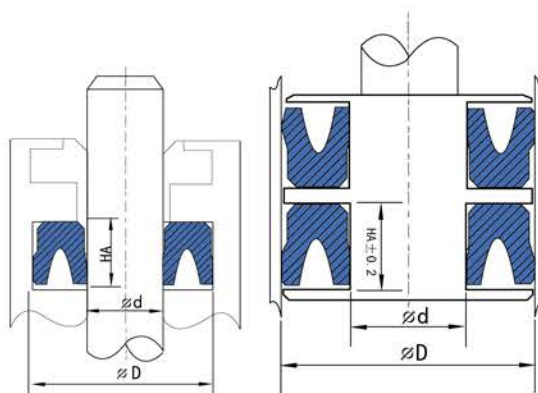
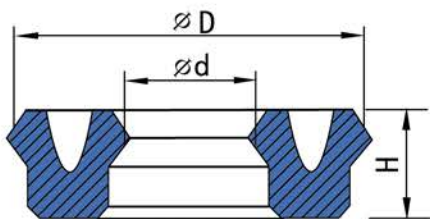

型号 PART No	尺寸 Size(mm)			
	Φd	ΦD	H	G
UPI	34.93	42.93	5.69	6.3
UPI	35	41	5	6
UPI	32	43	6	7
UPI	32	47	8	9
UPI	35	42	10	11
UPI	35	43	5	6
UPI	35	43	6	7
UPI	35	43	7	8
UPI	35	44	7	8
UPI	35	45	5	6
UPI	35	45	6	7
UPI	35	45	7	8
UPI	35	45	8	9
UPI	35	45	10	11
UPI	35	45	6	7
UPI	35	45	8	9
UPI	35	46	10	11
UPI	35	46	6	7
UPI	35	46	8	9
UPI	35	47	10	11
UPI	35	48	8	9
UPI	35	48	9	10
UPI	35	50	10	11
UPI	35	50	10	11
UPI	35	50	6	7
UPI	35	55	10	11
UPI	35.5	45	4	5
UPI	35.5	50.5	5.3	6
UPI	36	44	8	9
UPI	36	44	6.5	7.5
UPI	36	44	6	7
UPI	36	45	7	8
UPI	36	46	10	11
UPI	36	46	4	5
UPI	36	46	8	9
UPI	36	48	10	11

型号 PART No	尺寸 Size(mm)			
	Φd	ΦD	H	G
UPI	37	47	5	6
UPI	37	47	6.5	7.5
UPI	38	45	6	7
UPI	38	45	6	7
UPI	38	45.5	10	11
UPI	38	48	6	7
UPI	38	45	7	8
UPI	38	52	8	9
UPI	38	50	8	9
UPI	38	50	9	10
UPI	38	50	10	11
UPI	38	52	10	11
UPI	38	55	10	11
UPI	38	58	9.7	10.7
UPI	38	58	10	11
UPI	38	60	10	11
UPI	38	62	12	13
UPI	39	48	6.5	7.5
UPI	39	54	10	11
UPI	39	58	13	14
UPI	40	48	5	6
UPI	40	48	6	7
UPI	40	48	8	9
UPI	40	48	10	11
UPI	40	48	11	12
UPI	40	50	5	6
UPI	40	50	6	7
UPI	40	50	6.5	7.5
UPI	40	50	7	8
UPI	40	50	8	9
UPI	40	50	9	10
UPI	40	50	10	11
UPI	40	52	7	8
UPI	40	52	8	9
UPI	40	52	10	11

廠 家：德國歐博斯

生產材料：除目錄內規格外，亦可依客戶圖面生產

工作溫度：建議常態工作溫度在80°C以下

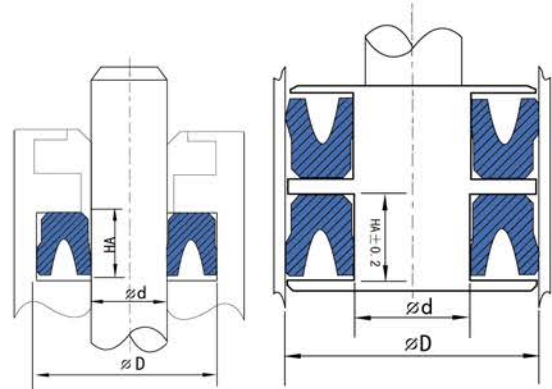
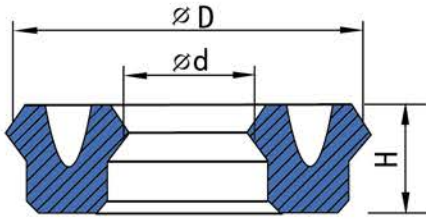

型号 PART No	尺寸 Size(mm)			
	Φd	ΦD	H	G
UPI	40	55	8	9
UPI	40	55	10	11
UPI	40	56	6	7
UPI	40	57	7.5	8.5
UPI	40	60	10	11
UPI	40	60	12	13
UPI	40	63	13	14
UPI	40	65	10	11
UPI	40	65	12	13
UPI	41	57	10	11
UPI	41	61	10	11
UPI	40	55	9	10
UPI	42	50	6	7
UPI	42	50	8	9
UPI	42	52	6	7
UPI	42	52	8	9
UPI	42	52	10	11
UPI	42	53	9	10
UPI	42	55	7	8
UPI	42	55	8	9
UPI	42	62	12	13
UPI	43	53	7.5	8
UPI	43	55	6	7
UPI	44	50	8.5	9
UPI	44.5	54.5	6	7
UPI	45	52	8	9
UPI	45	52	10	11
UPI	45	53	5.3	6
UPI	45	53	6	7
UPI	45	53	8	9
UPI	45	53	10	11
UPI	45	55	5	6
UPI	45	55	6	7
UPI	45	55	6.5	7
UPI	45	55	7	8
UPI	45	55	7.5	8

型号 PART No	尺寸 Size(mm)			
	Φd	ΦD	H	G
UPI	45	56	7	8
UPI	45	56	10	11
UPI	45	58	10	11
UPI	45	58	12	13
UPI	45	60	9	10
UPI	45	60	10	11
UPI	45	60	12	13
UPI	45	61	10	11
UPI	45	63	8	9
UPI	45	63	10	11
UPI	45	63	12	13
UPI	45	65	10	11
UPI	45	65	12	13
UPI	45	66	10	11
UPI	45	70	12	13
UPI	45	55	8	9
UPI	42	55	10	11
UPI	45	70	15.5	17.5
UPI	45	70	16	18
UPI	46	56	6	7
UPI	46	56	8	9
UPI	46	62	10	11
UPI	47	55	10	11
UPI	48	58	6	7
UPI	48	58	8	9
UPI	48	58	10	11
UPI	48	60	6	7
UPI	48	60	8	9
UPI	48	63	10	11
UPI	49.5	57	5	6
UPI	50	57	10	11
UPI	50	58	5.3	6
UPI	50	58	6	7
UPI	50	58	8	9
UPI	50	58	12	13
UPI	50	60	5	6

廠 家：德國歐博斯

生產材料：除目錄內規格外，亦可依客戶圖面生產

工作溫度：建議常態工作溫度在80°C以下

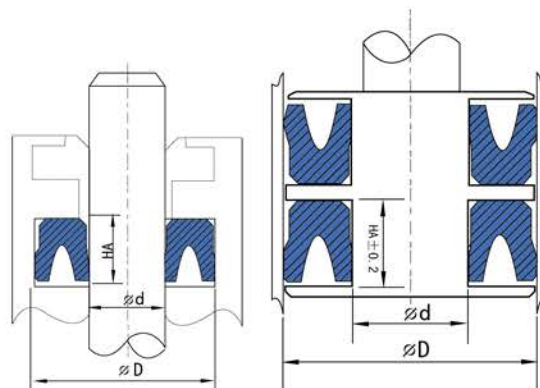
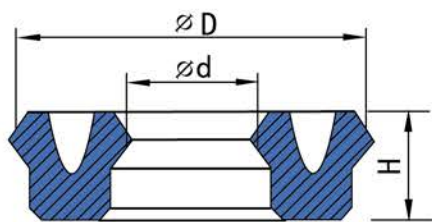

型号 PART No	尺寸 Size(mm)			
	Φd	ΦD	H	G
UPI	50	60	6	7
UPI	50	60	6.5	7.5
UPI	50	60	7	8
UPI	50	60	8	9
UPI	50	60	10	11
UPI	50	60	12	13
UPI	50	62	9	10
UPI	50	62	9.5	10.5
UPI	50	62	10	11
UPI	50	62	12	13
UPI	50	63	6	7
UPI	50	63	6.5	7.5
UPI	50	63	8	9
UPI	50	63	10	11
UPI	50	65	6	7
UPI	50	65	7.5	8.5
UPI	50	65	8	9
UPI	50	65	9	10
UPI	50	65	10	11
UPI	50	65	12	13
UPI	50	66	12	13
UPI	50	68	10	11
UPI	50	63	12	13
UPI	50	70	8	9
UPI	50	70	10	11
UPI	50	70	12	13
UPI	50	70	18	20
UPI	50	75	12.5	13.5
UPI	50.9	70	13	14
UPI	51	66	14	15
UPI	52	62	12	13
UPI	52	65	6	7
UPI	52	65	8	9
UPI	52	70	12	13
UPI	52	72	10	11
UPI	53	63	6	7

型号 PART No	尺寸 Size(mm)			
	Φd	ΦD	H	G
UPI	53	63	6.5	7.5
UPI	53	63	8	9
UPI	53	63	10	11
UPI	53	65	8	9
UPI	53	73	12	13
UPI	54	64	6	7
UPI	54	70	12	13
UPI	55	63	8	9
UPI	55	65	5	6
UPI	55	65	6	7
UPI	55	65	8	9
UPI	55	65	10	11
UPI	55	65	12	13
UPI	55	66	10	11
UPI	55	70	7.5	8.5
UPI	55	70	8	9
UPI	55	70	9	10
UPI	55	70	10	11
UPI	55	70	12	13
UPI	55	71	12	13
UPI	55	72	10	11
UPI	55	75	10	11
UPI	55	75	12	13
UPI	55	76	10	11
UPI	55	66	6	7
UPI	55	66	6.5	7.5
UPI	56	66	8.5	9.5
UPI	56	66	10	11
UPI	55	65	7	8
UPI	53	63	12	13
UPI	52	72	12	13
UPI	56	71	11.5	12.5
UPI	56	76	12	13
UPI	57	63	8	9
UPI	57	63	10	11
UPI	58	68	6	7

廠 家：德國歐博斯

生產材料：除目錄內規格外，亦可依客戶圖面生產

工作溫度：建議常態工作溫度在80°C以下

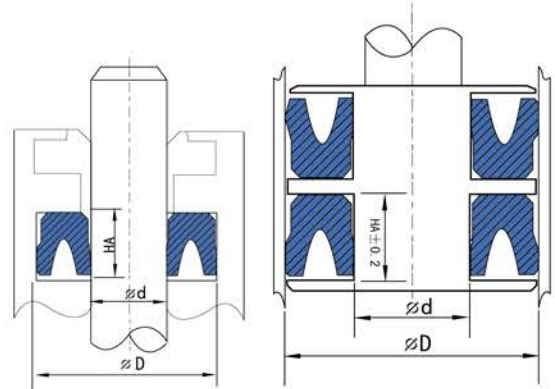
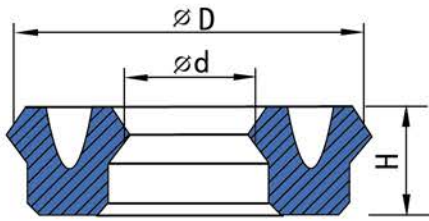

型号 PART No	尺寸 Size(mm)			
	Φd	ΦD	H	G
UPI	60	68	8	9
UPI	60	68	11	12.5
UPI	60	68	14	15
UPI	60	70	5	6
UPI	60	70	6	7
UPI	60	70	8	9
UPI	60	70	10	11
UPI	60	70	12	13
UPI	60	71	7	8
UPI	60	72	10	11
UPI	60	73	8	9
UPI	60	75	8	9
UPI	60	75	9	10
UPI	60	75	10	11
UPI	60	75	12	13
UPI	60	75	13	14
UPI	60	76	12	13
UPI	60	80	6	7
UPI	60	80	10	11
UPI	60	80	12	13
UPI	60	80	18	20
UPI	60	85	10	11
UPI	60	85	12	13
UPI	60	85	12.5	13.5
UPI	60	85	15	17
UPI	60	90	16	18
UPI	60	90	5	6
UPI	61	67	6	7
UPI	61	71	5	7.5
UPI	61	71	15.5	17.5
UPI	62	70	10	11
UPI	62	72	10	11
UPI	62	75	10	11
UPI	62	75	10	11
UPI	61	71	7	8
UPI	62	75	12	13

型号 PART No	尺寸 Size(mm)			
	Φd	ΦD	H	G
UPI	60	70	7	8
UPI	62	80	10	11
UPI	62	82	10	11
UPI	62	82	12	13
UPI	63	71	8	9
UPI	63	73	8	7
UPI	63	73	12	13
UPI	63	75	6	7
UPI	63	75	10	11
UPI	63	75	12	13
UPI	63	75	14	15
UPI	63	78	10	11
UPI	63	80	10	11
UPI	63	80	12	13
UPI	63	80	16	18
UPI	63	83	12	13
UPI	64	76	9.5	10.5
UPI	64	80	8	9
UPI	64	80	12	13
UPI	65	73	8	9
UPI	65	73	11.5	12.5
UPI	65	73	6	7
UPI	65	75	8	10
UPI	65	75	10	11
UPI	65	75	12	13
UPI	65	75	10	11
UPI	65	76	10	11
UPI	65	79	7.5	8.5
UPI	65	80	8.4	9.5
UPI	65	80	9	10
UPI	65	80	10	11
UPI	65	80	11	12
UPI	65	80	12	13
UPI	65	80	10	11
UPI	65	85	12	13
UPI	65	85	10	11

廠 家：德國歐博斯

生產材料：除目錄內規格外，亦可依客戶圖面生產

工作溫度：建議常態工作溫度在80°C以下

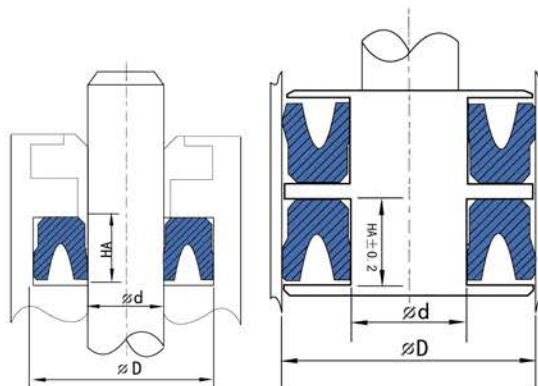
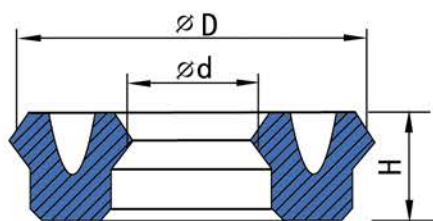

型号 PART No	尺寸 Size(mm)			
	Φd	ΦD	H	G
UPI	67	77	9.5	10.5
UPI	67	77	12	13
UPI	67	87	12	13
UPI	67	95	11.5	12.5
UPI	65	90	12	13
UPI	65	90	10	11
UPI	63	83	10	11
UPI	68	78	12	13
UPI	68	80	9	10
UPI	70	80	5	6
UPI	70	80	6	7
UPI	70	80	8	9
UPI	70	80	10	11
UPI	70	80	12	13
UPI	70	81	10	11
UPI	70	82	10	11
UPI	70	82	12	13
UPI	70	83	12	13
UPI	70	84	10	11
UPI	70	85	8	9
UPI	70	85	9	10
UPI	70	85	10	11
UPI	70	85	10.5	11.5
UPI	70	85	12	13
UPI	70	90	10	11
UPI	70	90	12	13
UPI	70	90	13	14
UPI	70	90	13.5	14.5
UPI	70	90	15	17
UPI	70	90	18	20
UPI	70	91	10	11
UPI	70	95	12	13
UPI	71	80	6	7
UPI	71	81	6	7
UPI	71	91	12	13
UPI	73	85	10	11

型号 PART No	尺寸 Size(mm)			
	Φd	ΦD	H	G
UPI	75	85	6	7
UPI	75	85	10	11
UPI	75	85	12	13
UPI	75	86	10	11
UPI	75	90	9	10
UPI	75	90	10	11
UPI	75	90	12	13
UPI	75	95	10	11
UPI	75	95	12	13
UPI	75	95	13	14
UPI	75	95	13.5	14.5
UPI	75	100	15	17
UPI	75	95	8	9
UPI	76	82	5	6
UPI	76	86	14	15
UPI	76	91	14	15
UPI	76	92	12	13
UPI	76	90.5	10	11
UPI	76.5	86	14	15
UPI	78	95	11.5	12.5
UPI	78	88	8	9
UPI	80	90	5	6
UPI	80	90	6	7
UPI	80	90	8	9
UPI	80	90	10	11
UPI	80	90	12	13
UPI	80	91	10	11
UPI	80	92	8.7	7
UPI	80	93	8	9
UPI	80	94	10	11
UPI	80	95	9	10
UPI	80	95	10	11
UPI	80	95	12	13
UPI	80	96	12	13
UPI	80	100	10	11
UPI	80	100	12	13

廠 家：德國歐博斯

生產材料：除目錄內規格外，亦可依客戶圖面生產

工作溫度：建議常態工作溫度在80°C以下

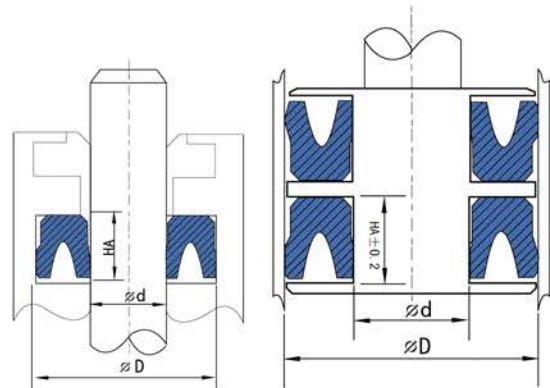
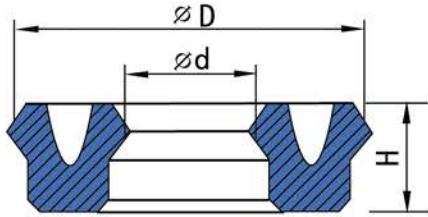

型号 PART No	尺寸 Size(mm)			
	Φd	ΦD	H	G
UPI	80	100	13	14.5
UPI	80	100	13.5	14.5
UPI	80	100	15	17
UPI	80	105	12	13
UPI	80	110	12	13
UPI	80	110	15	17
UPI	81	100	16	18
UPI	85	93	8	9
UPI	85	93	11.5	12.5
UPI	85	95	5	6
UPI	85	95	8.5	9.5
UPI	85	95	9	10
UPI	85	95	12	13
UPI	85	96	10	11
UPI	85	97	9	10
UPI	85	100	9	10
UPI	85	100	10	11
UPI	85	100	12	13
UPI	80	95	6	7
UPI	80	90	9	10
UPI	80	105	10	11
UPI	81	91	6	7
UPI	85	105	12	13
UPI	85	105	15	17
UPI	85	105	18	20
UPI	85	110	12	13
UPI	86	96	11.5	12.5
UPI	87	95	11.5	12.5
UPI	88	100	9	10
UPI	90	100	5	6
UPI	90	100	8	9
UPI	90	100	10	11
UPI	90	100	12	13
UPI	90	102	14	15
UPI	90	105	9	10
UPI	90	105	11.5	12.5

型号 PART No	尺寸 Size(mm)			
	Φd	ΦD	H	G
UPI	90	105	12	13
UPI	90	110	9	10
UPI	90	110	10	11
UPI	90	110	12	13
UPI	90	110	13	14
UPI	90	110	15	17
UPI	90	115	12	13
UPI	90	115	15	17
UPI	90	120	12	13
UPI	91	97	5	6
UPI	95	105	7	8
UPI	95	105	10	11
UPI	95	105	11.5	12.5
UPI	95	105	12	13
UPI	95	105	14	15
UPI	95	110	9	10
UPI	95	110	10	11
UPI	95	110	12	13
UPI	95	115	12	13
UPI	95	115	13.5	14.5
UPI	95	115	15	17
UPI	95	115	18	20
UPI	95	120	12	13
UPI	95	120	13	14
UPI	97	105	14	15
UPI	98	112	9	10
UPI	100	110	5	6
UPI	90	120	16	17
UPI	90	100	6	7
UPI	92	112	10	11
UPI	100	110	6	7
UPI	100	110	8	9
UPI	100	110	11	12
UPI	100	110	15	17
UPI	100	112	9	10
UPI	100	115	9	10

廠 家：德國歐博斯

生產材料：除目錄內規格外，亦可依客戶圖面生產

工作溫度：建議常態工作溫度在80°C以下

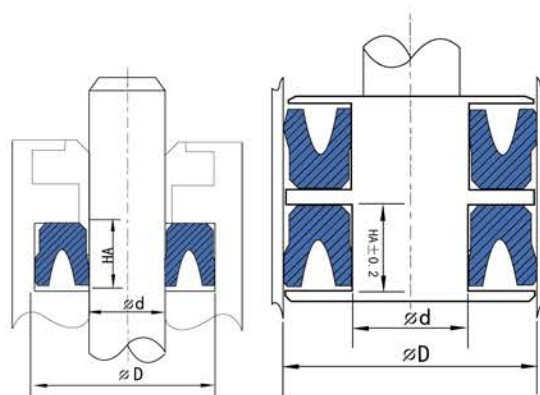
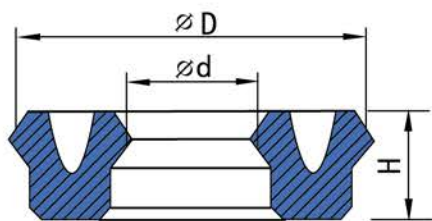

型号 PART No	尺寸 Size(mm)			
	Φd	ΦD	H	G
UPI	100	115	12	13
UPI	100	115	15	17
UPI	100	120	10	11
UPI	100	120	12	13
UPI	100	120	13.5	14
UPI	100	120	15	17
UPI	100	125	10	11
UPI	100	125	12	13
UPI	100	125	15	17
UPI	100	130	15	17
UPI	100.4	115	9	10
UPI	104	117	5.3	6
UPI	104.5	117	5.3	6
UPI	105	113	11	12
UPI	105	115	9	10
UPI	105	115	13.5	14
UPI	105	120	8	9
UPI	105	120	9	10
UPI	105	120	11	12
UPI	105	120	12	13
UPI	105	120	13	14
UPI	105	120	15	17
UPI	105	125	10	11
UPI	105	125	11	12
UPI	105	125	12	13
UPI	105	125	13	14
UPI	105	125	15	17
UPI	105	125	16	18
UPI	105	130	12	13
UPI	106	121	9	10
UPI	106	126	16	18
UPI	107	113	5	6
UPI	110	120	12	13
UPI	110	124	9.5	10.5
UPI	100	112	10	11
UPI	110	120	8	9

型号 PART No	尺寸 Size(mm)			
	Φd	ΦD	H	G
UPI	110	125	9	10
UPI	110	125	12	13
UPI	110	125	15	17
UPI	110	130	9	10
UPI	110	130	12	13
UPI	110	130	15	17
UPI	110	130	16	18
UPI	110	135	15	17
UPI	110	140	15	17
UPI	110	140	18	20
UPI	110	145	15	17
UPI	112	125	9	10
UPI	112	127	12	13
UPI	112	132	15	17
UPI	112	132	16	18
UPI	115	125	12	13
UPI	115	130	9	10
UPI	115	130	10	11
UPI	115	130	12	13
UPI	115	130	13.5	14.5
UPI	115	135	12	13
UPI	115	130	15	17
UPI	115	135	15	17
UPI	115	140	12	13
UPI	115	140	15	17
UPI	117	130	10	11
UPI	117	130	12	13
UPI	118	126	14	15
UPI	118	130	10	11
UPI	118	130	12	13
UPI	120	130	8	9
UPI	120	130	12	13
UPI	120	130	13	14
UPI	120	130	14	15
UPI	120	132	12	13
UPI	120	135	9	10

廠 家：德國歐博斯

生產材料：除目錄內規格外，亦可依客戶圖面生產

工作溫度：建議常態工作溫度在80°C以下

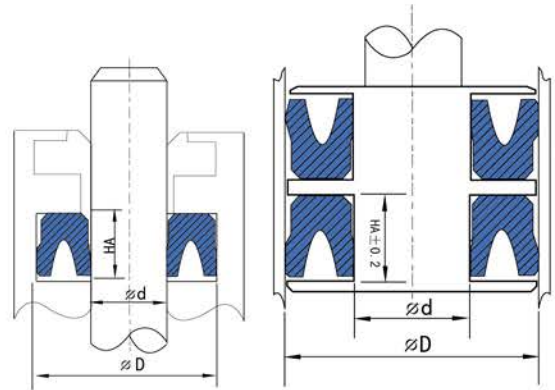
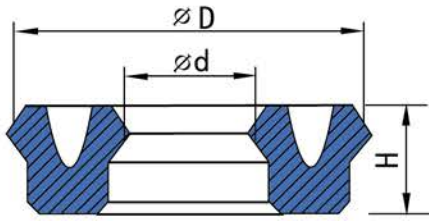

型号 PART No	尺寸 Size(mm)			
	Φd	ΦD	H	G
UPI	120	135	12	13
UPI	120	140	10	11
UPI	120	140	12	13
UPI	120	140	13	14
UPI	120	140	15	17
UPI	120	125	15	17
UPI	110	138	16	18
UPI	118	138	16	18
UPI	120	140	16	18
UPI	120	145	12	13
UPI	120	145	15	17
UPI	120	145	18	20
UPI	120	150	15	17
UPI	124	145	15	17
UPI	125	140	9	10
UPI	125	140	11	12
UPI	125	140	12	13
UPI	125	140	13	14
UPI	125	140	15	17
UPI	125	145	12	13
UPI	125	145	15	17
UPI	125	145	16	18
UPI	125	150	15	17
UPI	125	155	15	17
UPI	126	132	5	6
UPI	130	145	9	10
UPI	130	145	12	13
UPI	130	145	15	17
UPI	130	150	10	11
UPI	130	150	12	13
UPI	130	150	15	17
UPI	130	150	16	18
UPI	130	155	12	13
UPI	130	155	15	17
UPI	130	160	15	17
UPI	130	165	15	17

型号 PART No	尺寸 Size(mm)			
	Φd	ΦD	H	G
UPI	135	150	11	12
UPI	135	150	12	13
UPI	135	150	15	17
UPI	135	155	12	13
UPI	135	155	15	17
UPI	135	160	15	17
UPI	135	160	19	21
UPI	135	165	15	17
UPI	136	150	9	10
UPI	140	150	5	6
UPI	140	150	6	7
UPI	132	145	9.5	10.5
UPI	132	145	8.5	9.5
UPI	140	150	11	12
UPI	140	150	15	17
UPI	140	152	10	11
UPI	140	155	9	10
UPI	140	155	10	11
UPI	140	155	15	17
UPI	140	157	6	7
UPI	140	160	9	10
UPI	140	160	10	11
UPI	140	160	12	13
UPI	140	160	15	17
UPI	140	160	16	18
UPI	140	165	15	17
UPI	140	170	15	17
UPI	141	151	14	15
UPI	143	151	14	15
UPI	145	160	9	10
UPI	145	160	12	13
UPI	145	165	15	17
UPI	145	170	15	17
UPI	145	175	15	17
UPI	150	165	9	10
UPI	150	170	10	11

廠 家：德國歐博斯

生產材料：除目錄內規格外，亦可依客戶圖面生產

工作溫度：建議常態工作溫度在80°C以下

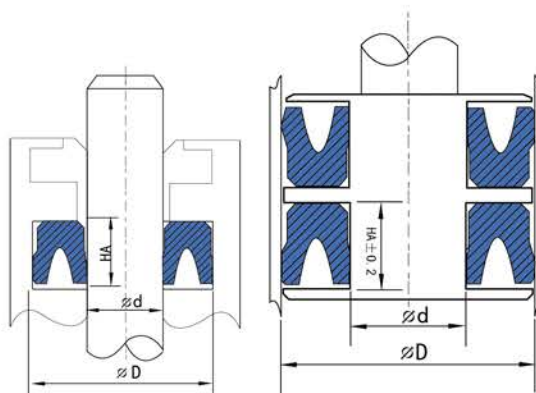
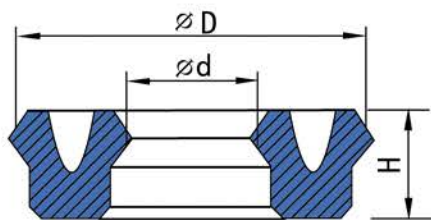

型号 PART No	尺寸 Size(mm)			
	Φd	ΦD	H	G
UPI	150	170	12	13
UPI	150	170	15	17
UPI	150	170	16	18
UPI	150	180	15	17
UPI	150	180	18	20
UPI	155	180	15	17
UPI	160	170	7.5	8.5
UPI	160	170	12	13
UPI	160	175	7.5	8.5
UPI	160	175	9	10
UPI	160	175	12	13
UPI	160	175	15	17
UPI	160	175	16	18
UPI	160	180	10	11
UPI	160	180	12	13
UPI	160	180	15	17
UPI	160	180	16	18
UPI	160	185	12	13
UPI	160	185	15	17
UPI	160	185	16	18
UPI	160	185	18	20
UPI	160	190	15	17
UPI	160	190	18	20
UPI	160	195	17	19
UPI	162	172	14	15
UPI	165	177	9	10
UPI	165	180	9	10
UPI	165	180	15	17
UPI	165	185	15	17
UPI	165	190	15	17
UPI	165	190	15	17
UPI	165	190	16	18
UPI	170	180	12	13
UPI	170	190	15	17
UPI	170	195	12	13
UPI	170	195	15	17

型号 PART No	尺寸 Size(mm)			
	Φd	ΦD	H	G
UPI	170	195	16	18
UPI	170	200	15	17
UPI	170	200	18	20
UPI	170	215	20	22
UPI	171	179	14	14
UPI	175	200	15	17
UPI	175	205	15	17
UPI	180	190	10	11
UPI	180	200	12	13
UPI	180	200	12.5	13.5
UPI	180	200	15	17
UPI	180	205	12	13
UPI	180	205	15	17
UPI	180	205	16	18
UPI	180	205	18	20
UPI	180	210	15	17
UPI	180	210	22	24
UPI	180	215	15	17
UPI	183	193	14	15
UPI	185	195	12	13
UPI	185	200	7.5	8.5
UPI	185	200	9	10
UPI	185	200	12	13
UPI	185	200	15	17
UPI	170	185	9	10
UPI	160	185	15	17
UPI	180	200	16	18
UPI	185	205	15	17
UPI	185	210	15	17
UPI	185	210	16	18
UPI	185	215	15	17
UPI	190	205	15	17
UPI	190	205	16	18
UPI	190	210	12	13
UPI	190	210	15	17
UPI	190	215	15	17

廠 家：德國歐博斯

生產材料：除目錄內規格外，亦可依客戶圖面生產

工作溫度：建議常態工作溫度在80°C以下

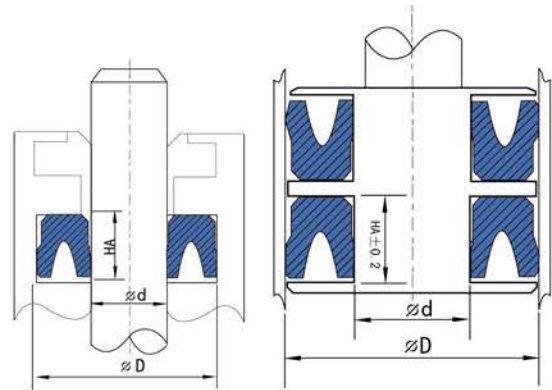
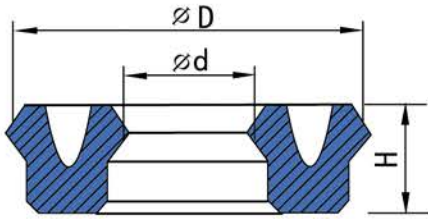

型号 PART No	尺寸 Size(mm)			
	Φd	ΦD	H	G
UPI	190	215	16	18
UPI	190	220	15	17
UPI	190	220	16	18
UPI	190	220	22	24
UPI	190	215	12	13
UPI	200	215	12	13
UPI	200	220	12	13
UPI	200	220	15	17
UPI	200	220	18	20
UPI	200	225	15	17
UPI	200	225	16	18
UPI	200	225	20	22
UPI	200	230	15	17
UPI	200	230	18	20
UPI	200	230	22	24
UPI	200	235	20	22
UPI	205	230	20	22
UPI	207	217	14	15
UPI	210	225	15	17
UPI	210	230	12	13
UPI	210	230	15	17
UPI	210	235	15	17
UPI	210	235	18	20
UPI	210	240	15	17
UPI	210	240	18	20
UPI	215	240	15	17
UPI	215	240	16	18
UPI	215	240	18	20
UPI	220	240	12	13
UPI	220	240	16	17
UPI	220	245	18	20
UPI	220	250	15	17
UPI	220	250	18	20
UPI	195	220	16	18
UPI	200	220	16	18
UPI	220	240	16	18

型号 PART No	尺寸 Size(mm)			
	Φd	ΦD	H	G
UPI	220	250	22	24
UPI	225	240	12	13
UPI	225	250	19	21
UPI	225	255	26	28
UPI	230	250	12.5	13.5
UPI	230	250	16	18
UPI	230	250	18	20
UPI	230	255	18	20
UPI	230	260	18	20
UPI	230	260	22	24
UPI	235	255	12	13
UPI	235	260	19	21
UPI	240	260	16	18
UPI	240	265	16	18
UPI	240	270	18	20
UPI	250	270	16	18
UPI	250	275	18	20
UPI	250	275	19	21
UPI	250	280	18	20
UPI	250	280	19	21
UPI	250	280	25	27
UPI	260	280	14	15
UPI	260	280	18	20
UPI	260	290	18	20
UPI	265	295	19	21
UPI	275	300	16	18
UPI	280	300	15	17
UPI	280	300	16	18
UPI	280	300	18	20
UPI	280	310	20	22
UPI	280	320	20	22
UPI	290	320	18	20
UPI	300	330	18	20
UPI	330	350	15	17
UPI	370	400	22	24

廠 家：德國歐博斯

生產材料：除目錄內規格外，亦可依客戶圖面生產

工作溫度：-40°C--200°C 根据不同橡胶材质而定

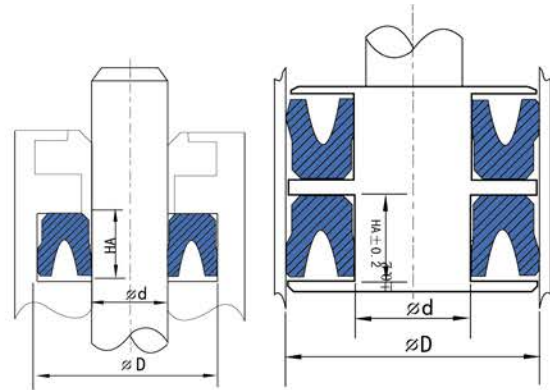
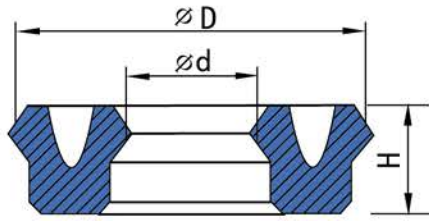

型号 PART No	尺寸 Size (mm)			
	d	D	H	HA
USH-6	6	11	4	4.7
USH-8A	8	14	4	4.7
USH-8	8	15	6	7
USH-10	10	16	5	5.7
USH-11.2	11.2	19.2	5	5.7
USH-12	12	20	5	5.7
USH-12	12	22	5	5.7
USH-14	14	22	5	5.7
USH-16	16	24	5	5.7
USH-18	18	26	5	5.7
USH-18A	18	28	5	5.7
USH-20	20	28	5	5.7
USH-20	20	30	4.7	5.4
USH-22	22	30	5	5.7
USH-22.4	22.4	30	5	5.7
USH-23.5	23.5	31.5	5	5.7
USH-25	25	33	5	5.7
USH-28	28	35.5	5	5.7
USH-30	30	40	6	5.7
USH-31	31	36	4	4.7
USH-31.5	31.5	41.5	6	7
USH-32A	32	40	6	7
USH-32	32	42	6	7
USH-35A	35	43	6	7
USH-35	35	45	6	7
USH-35.5	35.5	42.5	4	4.7
USH-35.5	35.5	45	6	7
USH-38	38	48	6	7
USH-40	40	50	6	7
USH-40	40	50	7	8
USH-45	45	55	6	7
USH-45A	45	56	7	8
USH-48	48	60	6	7
USH-50	50	60	6	7
USH-53	53	63	6	7
USH-55	55	65	6	7

型号 PART No	尺寸 Size (mm)			
	d	D	H	HA
USH-56	56	66	6	7
USH-60	60	70	6	7
USH-60A	60	71	6	7
USH-63	63	73	6	7
USH-65	65	75	6	7
USH-70	70	80	6	7
USH-71	71	80	6	7
USH-75	75	85	6	7
USH-80	80	90	6	7
USH-85	85	100	9	10
USH-90	90	105	9	10
USH-95	95	110	9	10
USH-100	100	115	9	10
USH-100	100	115	12	13
USH-106	106	120	8.5	9.5
USH-112	112	125	9	10
USH-112A	112	125	8.5	9.5
USH-125	125	140	9	10
USH-130	130	145	9	10
USH-135	135	150	9	10
USH-136	136	150	8.5	9.5
USH-140	140	155	9	10
USH-145	145	160	9	10
USH-150	150	165	9	10
USH-155	155	170	9	10
USH-160	160	175	9	10
USH-165	165	180	9	10
USH-170	170	190	9	10
USH-175	175	190	9	10
USH-180	180	200	12	13
USH-190	190	210	12	13
USH-200	200	220	12	13
USH-230	230	250	12	13
USH-250	250	270	12	13

廠家：德國歐博斯
 生產材料：除目錄內規格外，亦可依客戶圖面生產
 工作溫度：-40°C--200°C 根据不同橡胶材质而定

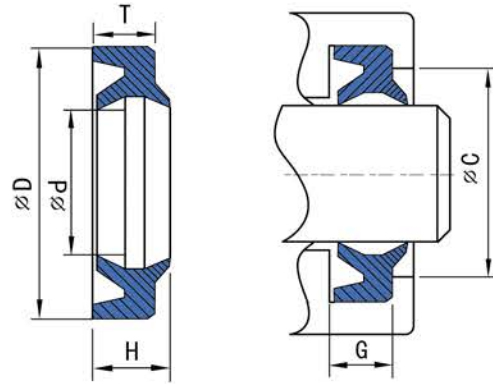

型号 PART No	尺寸 Size (mm)				
	d	D	h1	H	L
LBH-11.2	11.2	19.2	4.5	6	5
LBH-12.5	12.5	20.5	4.5	6	5
LBH-14	14	22.4	4.5	6	5
LBH-16	16	24.4	4.5	6	5
LBH-18	18	26.4	4.5	6	5
LBH-20	20	28.4	4.5	6	5
LBH-22	22	30.4	4.5	6	5
LBH-22.4	22.4	30.4	4.5	6	5
LBH-23.5	23.5	31.5	4.5	6	5
LBH-25	25	33.4	4.5	6	5
LBH-28	28	36.4	4.5	6	5
LBH-30	30	38.4	4.5	6	5
LBH-31.5	31.5	39.5	5	6.5	6
LBH-32	32	40	5	6.5	6
LBH-35	35	43	5	6.5	6
LBH-35.5	35.5	43.5	5	6.5	6
LBH-36	36	44	5	6.5	6
LBH-38	38	46	5	6.5	6
LBH-40	40	48	5	6.5	6
LBH-45	45	53	5	6.5	6
LBH-50	50	58	5	6.5	6
LBH-53	53	61	5	6.5	6
LBH-55	55	63	5	6.5	6
LBH-56	56	64	5	6.5	6
LBH-58	58	66	5	6.5	6
LBH-60	60	68	5	6.5	6
LBH-65	65	73	5	6.5	6
LBH-67	67	75	5	6.5	6
LBH-70	70	80	6	8	7
LBH-71	71	81	6	8	7
LBH-75	75	85	6	8	7
LBH-80	80	90	6	8	7
LBH-85	85	95	6	8	7
LBH-90	90	100	6	8	7
LBH-95	95	105	6	8	7
LBH-100	100	110	6	8	7

型号 PART No	尺寸 Size (mm)				
	d	D	h1	H	L
LBH-105	105	115	6	8	7
LBH-106	106	116	6	8	7
LBH-110	110	120	6	8	7
LBH-112	112	122	6	8	7
LBH-115	115	125	6	8	7
LBH-118	118	128	6	8	7
LBH-125	125	138	7	9.5	8
LBH-132	132	145	7	9.5	8
LBH-140	140	153	7	9.5	8
LBH-145	145	158	7	9.5	8
LBH-150	150	163	7	9.5	8
LBH-160	160	173	7	9.5	8
LBH-170	170	183	7	9.5	8
LBH-180	180	193	7	9.5	8
LBH-200	200	213	7	9.5	8
LBH-250	250	266	9	12	10



氣彈簧密封

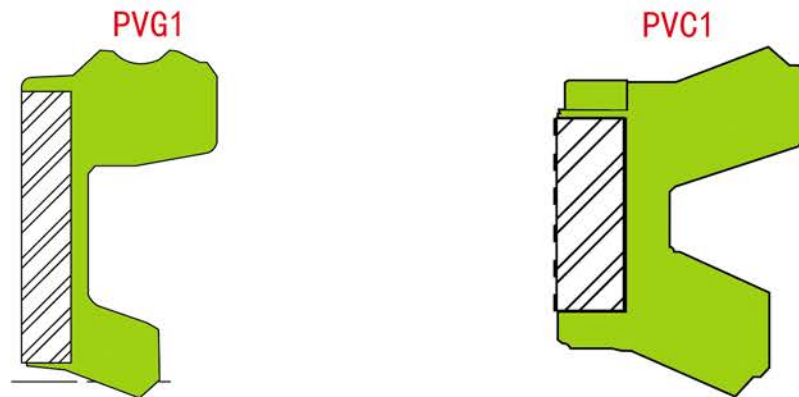

歐博斯-氣彈簧油封的常見規格

序號	型式	尺寸	材質	杆徑 x 管內徑
1	PVG1	10X16X4.5	NBR	10X16
2	PVG1	10X20X5	NBR	10X20
3	PVG1	10X23X5	NBR	10X23
4	PVG1	10X24X5	NBR	10X24
5	PVG1	10X25X5	NBR	10X25
6	PVG1	12.5X20X5	NBR	12.5X20
7	PVG1	12.5X24X5	NBR	12.5X24
8	PVG1	12.5X25X5	NBR	12.5X25
9	PVG1	14X24X5	NBR	14X24
10	PVG1	4X10X3	NBR	4X10
11	PVG1	6X11.8X4	NBR	6X11.8
12	PVG1	6X12X3	NBR	6X12
13	PVG1	6X13X3	NBR	6X13
14	PVC1	6X13X3.3	NBR	6X13
15	PVG1	6X13X4	NBR	6X13
16	PVG1	6X13X4.8	NBR	6X13
17	PVG1	8X16X5	NBR	8X16
18	PVG1	9X16X5	NBR	9X16
19	PVG1	9X22X5	NBR	9X22





OBS·南京分公司

南京歐博斯橡膠製品有限公司

地址：南京市浦口區浦東北路5號明發江蘇總部基地13棟6層

電話：025-58608320/58608920

傳真：025-58607128

郵編：210031

E-mail: nj-ly@obs-seal.com

網址：www.obs-seal.com