

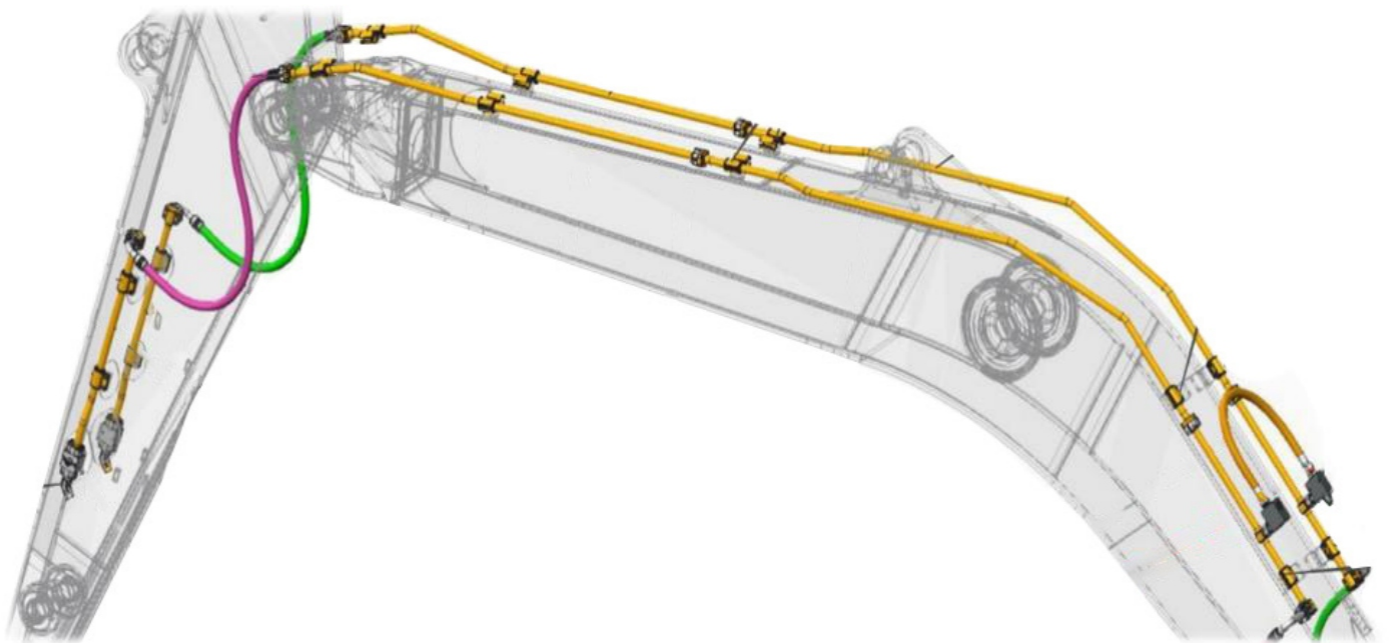

**MENGZHONG PIPELINE**



# **WELDING FREE PIPELINE INSTALLATION SOLUTION FOR EXCAVATOR**

---

ECONOMY, ENGINEERING, MANUFACTURING, ASSEMBLY, QUALITY CONTR

# MENGZHONG® HYDRAULIC TUBE AND HOSE

## Excavator Crushing Hammer Pipeline Solutions And Manufacturers

Mengzhong offers high quality, reliable high pressure hydraulic products tubing to hydraulic hose assemblies - all supporting the latest innovations and engineering for world class applications. Our products are matched with many well-known machinery brands, such as Liugong, Sany, Revo, Kobelco, Hyundai and so on.

We believe that with more than 10 years of experience in the solderless hydraulic piping industry, we can provide the best service to our customers.



# SUITABLE, EVEN BETTER

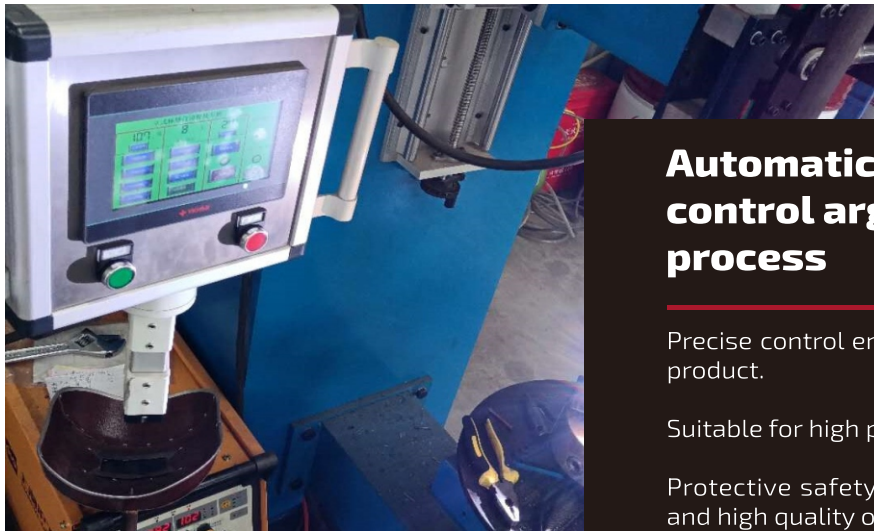

## Automatic numerical control argon arc welding process

Precise control ensures the consistency of the product.

Suitable for high pressure tubing applications

Protective safety Settings, high repeatability and high quality output processes

We combine the advantages of automatic control and argon arc welding to achieve efficient and high-quality pipeline welding.

Numerical control system is used to control and monitor the welding process. It can precisely control the welding arc length and moving speed during the welding process to achieve stable welding quality and consistency. The welding defects such as pores, inclusions and oxidation are reduced during the welding process. Greatly improve the tightness and strength of welded joints, to ensure the reliability and durability of the pipeline.

## CNC PIPE BENDING TECHNOLOGY

Thanks to the application of numerical control technology, we have realized the high precision, high efficiency and reliability of the excavator hydraulic system pipeline bending processing;

We have a high pursuit of the regularity of the bend, and now we can precisely control the bending Angle, bending radius and bending position to ensure the exact match and good installation of the pipe. The high precision processing ensures the quality and performance of the pipeline, and improves the efficiency and reliability of the entire hydraulic system.

In addition, the reliability of the pipeline is guaranteed. Through the precise control and monitoring of numerical control technology, the deformation, cracking or distortion caused by the bending process can be avoided. This can ensure the structural integrity and tightness of the pipeline, reduce the risk of pipeline system failure and leakage, and improve the operational stability and safety of hydraulic equipment.

- 
- ▶ High precision, high efficiency and reliability of pipe bending processing
  - ▶ The efficiency and reliability of the whole hydraulic system are improved.
  - ▶ Avoid problems such as deformation, cracking or distortion.



## ELECTROSTATIC SPRAYING OF PIPELINES

Hydraulic lines often face harsh working environments, such as high temperature, humidity and chemical erosion. The pipeline processing of Mengzhong adopts environmentally friendly and reliable coating process, and electrostatic spray painting has excellent adhesion ability. By using the baking process, a solid protective layer can be formed on the surface of the pipeline to make it firmly bonded with the pipeline material. This strong adhesion ensures the reliability and durability of the piping system, reducing the risk of oil spills and leaks. Compared with traditional coating or galvanizing processes, the baking process reduces environmental pollution and the release of chemical substances.



### ELECTROSTATIC PAINTING

- ▶ Stronger adhesion
- ▶ More wear-resistant
- ▶ Resistant to corrosion and more environmentally friendly.
- ▶ The original model matches the color

## HIGH LIFE HYDRAULIC HOSE

The patented hose series equipped with our products has the characteristics of long life (supporting the use of force connection, service life of more than 5 years, warranty period of 2 years), low bending, high pressure (greater than 25% DIN/SAE standard), and can fully meet the needs of various hydraulic machinery for lightweight, high pressure, long life hose.



## CLEAN PIPING DELIVERY GUARANTEE

All steel pipes use high-pressure sponge spray process to clean the inner wall, so that there is no dust and no oil, to ensure that each steel pipe delivered is clean and tidy.



MENGZHONG EXISTING ORIGINAL MATCHED BRAND DISPLAY



MENGZHONG IS CURRENTLY SUPPORTING THE HOST PLANT OF THE COOPERATIVE FACTORY :

- WEICHAIR REWO HEAVY INDUSTRY
- KOBELCO CONSTRUCTION MACHINERY (CHINA) CO., LTD
- ANY HEAVY INDUSTRY
- CHANGZHOU MODERN CONSTRUCTION MACHINERY CO., LTD
- LIUGONG GROUP
- CARTER XINCHANG MACHINE ENGINEERING CO., LTD
- LINGONG
- ZOOMLION
- SUNWARD

# ELECTRIC WELDING LINES AND SPARE VALVES

## VALVE

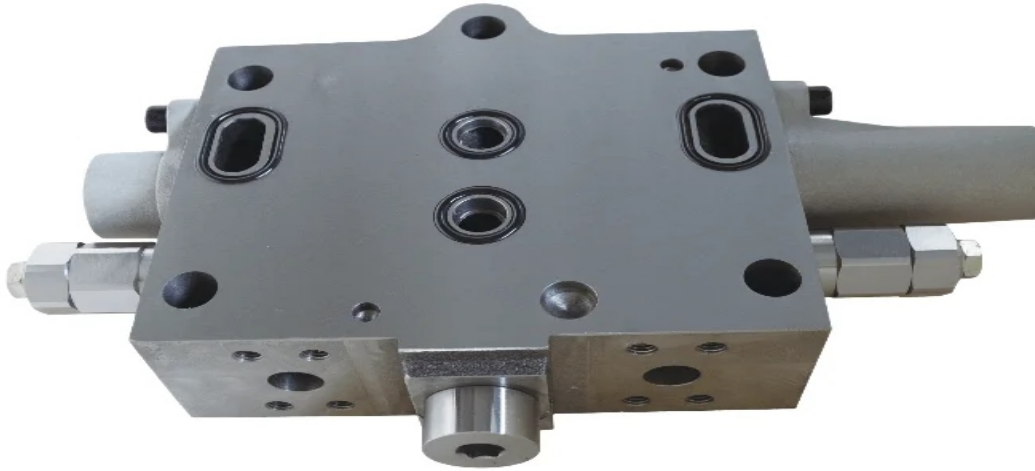

**CAT Confluence valve  
( with pressure regulating rod )**



**PC200-6 Spare valve  
( without pressure regulating rod )**

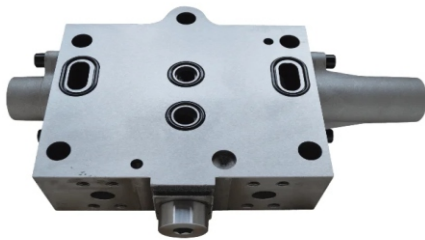

**CAT Confluence valve  
( without pressure regulating rod )**

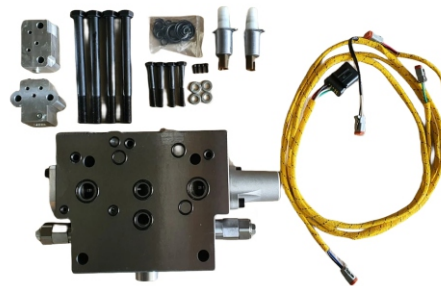



# ELECTRIC WELDING LINES AND SPARE VALVES

## WELDING PIPING KITS

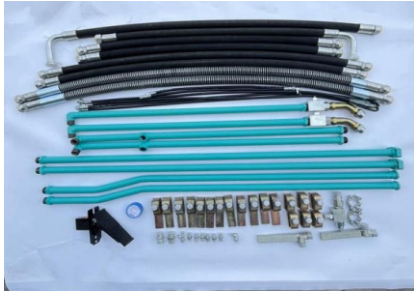







## ORIGINAL MAIN ENGINE DESIGN

Our hammer hydraulic line products have received numerous Oems certifications. It is the original supporting parts.

The pipelines undergo rigorous engineering calculations and testing to ensure that they can withstand high pressure and shock loads during operation. Our rational design and reliable material selection ensure the efficient, safe and reliable operation of excavators in crushing operations.

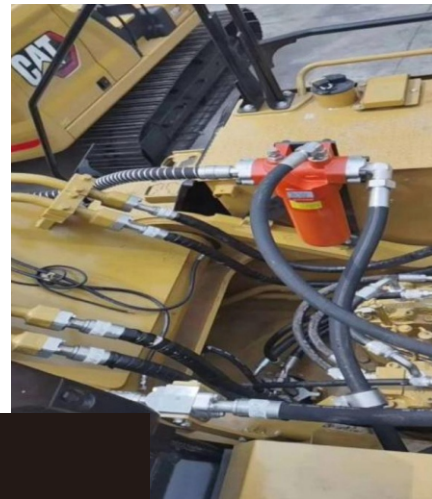
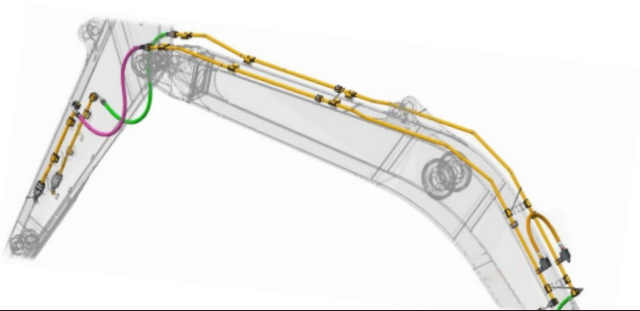

With a well-developed data collecting system for most brand of excavator pipeline design

### Accessories for hydraulic systems





# WELDING FREE HYDRAULIC LINE FOR CAT

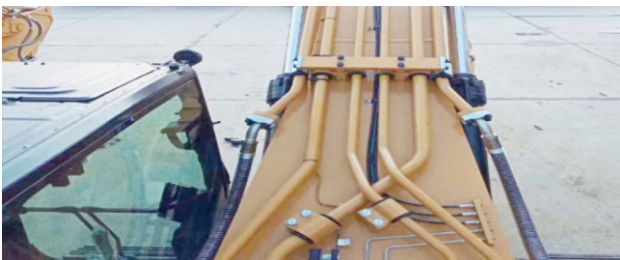



# WELDING FREE HYDRAULIC LINE FOR SANY





# WELDING FREE HYDRAULIC LINE FOR LIUGONG

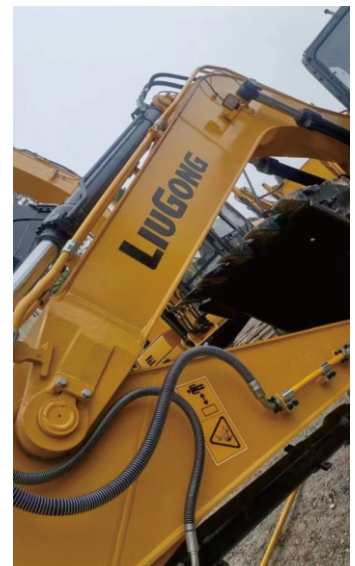
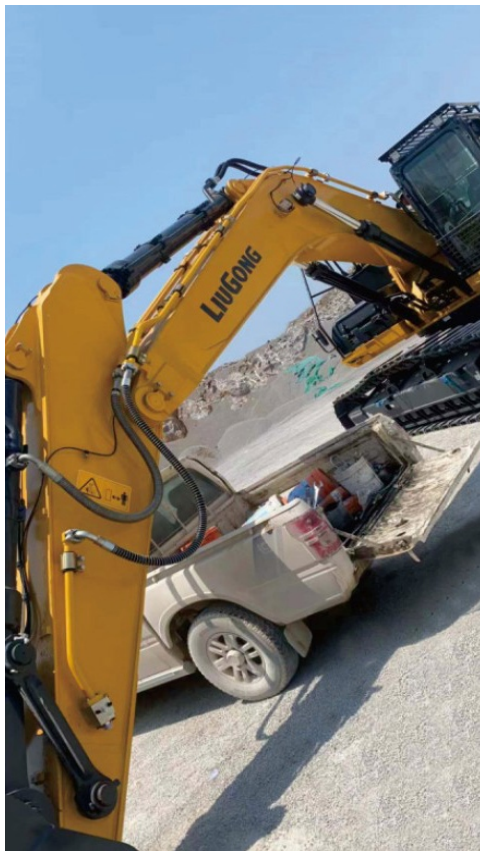





# WELDING FREE HYDRAULIC LINE FOR LOVOL

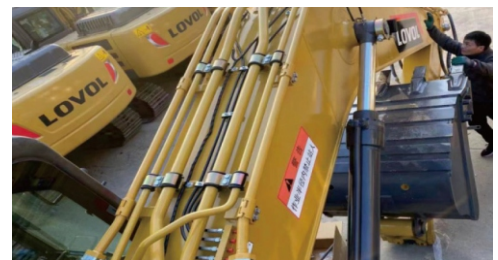
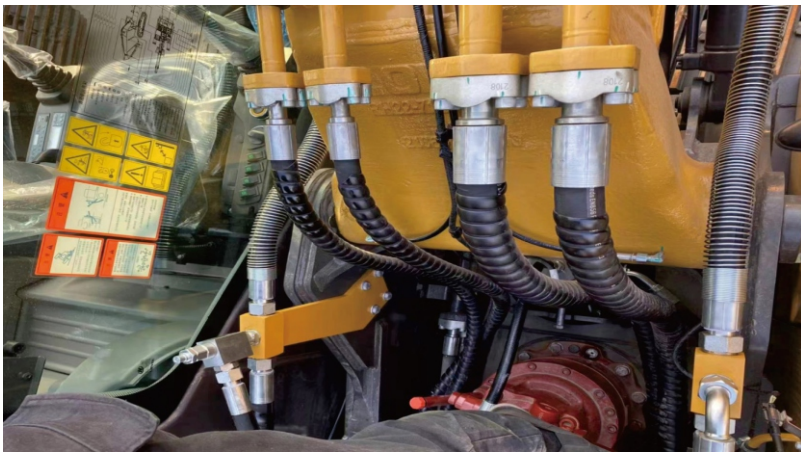

# KOBELCO

## WELDING FREE HYDRAULIC LINE FOR KOBELCO

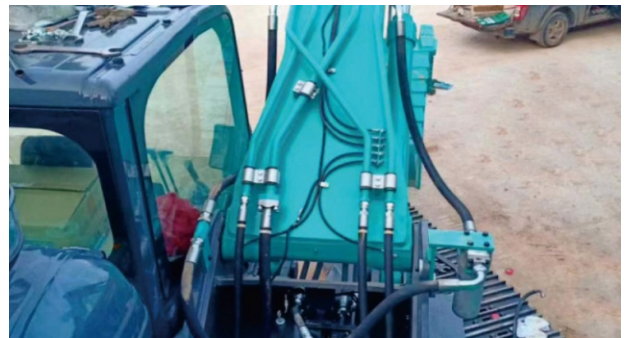
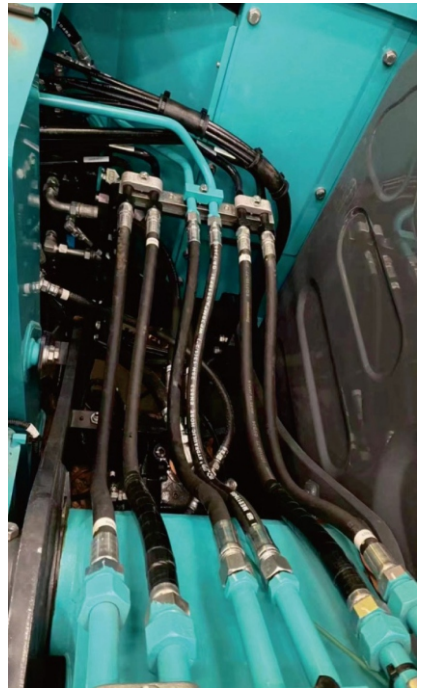
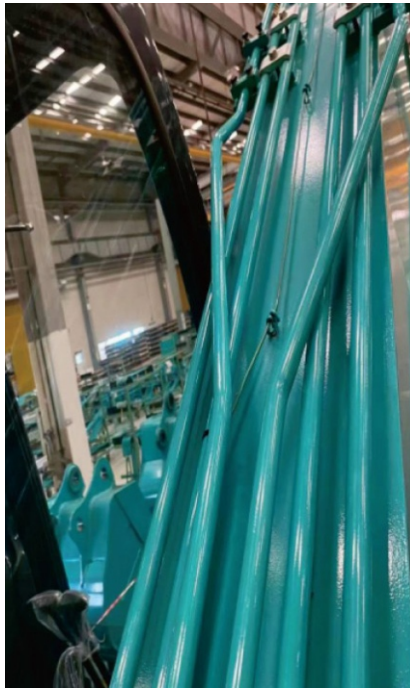

**▲ HYUNDAI**

# WELDING FREE HYDRAULIC LINE FOR HYUNDAI





# WELDING FREE HYDRAULIC LINE FOR SDLG

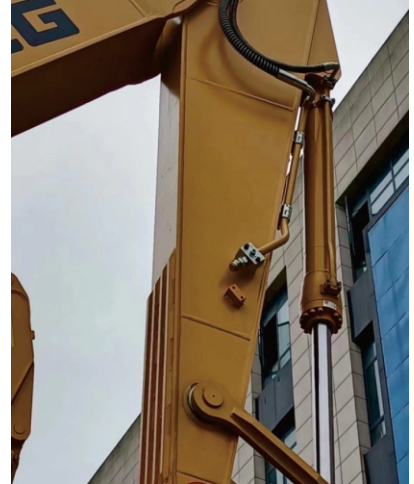



# WELDING FREE HYDRAULIC LINE FOR XCMG

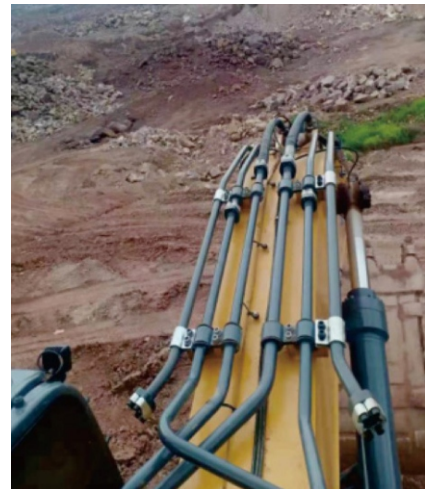

# KOMATSU®

## WELDING FREE HYDRAULIC LINE FOR KOMATSU



# ***DOOSAN***

## **WELDING FREE HYDRAULIC LINE FOR DOOSAN**



# VOLVO

## WELDING FREE HYDRAULIC LINE FOR HITACHI





# HITACHI

## WELDING FREE HYDRAULIC LINE FOR VOLVO



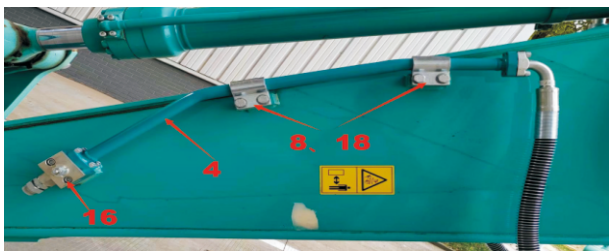
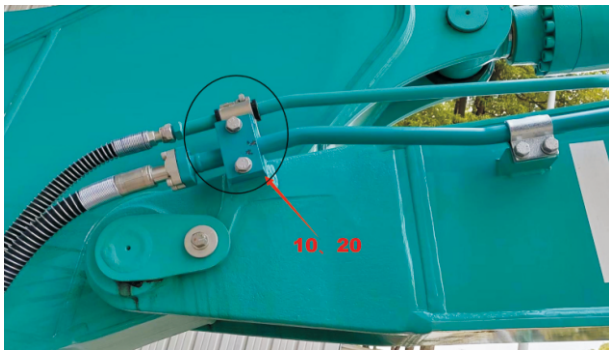

神钢200-12配置明细 (SK200-12)				
序号	品名	规格	数量	单位
1		神钢200-12前臂	2	根
2		神钢200-12进油后臂	1	根
3	铁管	神钢200-12回油后臂	1	根
4		神钢200-12小臂总成(带球阀\堵头)	2	根
5		回油后臂短钢管	1	根
6	支架	回油滤支架	1	个
7	管夹	后臂桥型管夹	1	个
8		1寸蝴蝶夹	14	对
9		1.2寸胶套	1	个
10		前臂专用管夹	2	个
11		F44法兰夹	8	对
12		F50法兰夹	2	对
13		回油过桥支架	1	个
14		M10*35内六角	40	颗
15		M12*40内六角	4	颗
16		M12*60内六角	4	颗
17		M14*35内六角	2	颗
18		M16*40	32	颗
19		M16*55	2	颗
20		M16*70	4	颗
21	三通	1/4C母三通 中间14*1.5H	3	个
22	对丝	1/4A-14*1.5H	2	个
23		1/4A-14*1.5H 90°	1	个
24		1.5寸A-42*2H	1	个
25	脚踏阀	传感器三通	1	个
26		传感器三通	1	个
27	胶管	φ25*4S 1.8米 两头F44一头直 一头90°	2	根
28		φ25*4S 0.9米 一头F50 90° 一头F44直	1	根
29		φ25*4S 1.3米 一头36H直 一头F44-90°	1	根
30		φ32*2S 1.2米 一头42H直 一头42H-90°	1	根
31		φ32*2S 0.77米 两头42*2H 直	1	根
32		φ6*1S 3.5米 一头14*1.5H 一头1/4C	1	根
33		1/4D外丝堵头	1	个
34		φ6*1S 0.6米 两头14*1.5H 一头90°	2	根

Note: As shown in the figure, first secure the 4 arm assembly so that the clamp and bolt are loose, then tighten the 16 bolts, and finally tighten the 8 18 clamp bolts

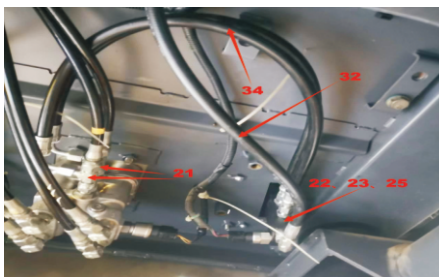
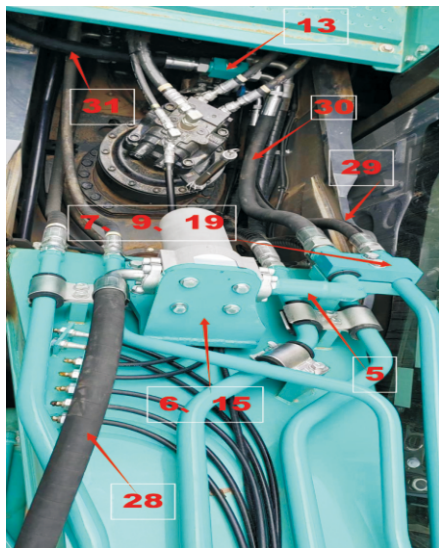

Install A low-voltage sensor at port A of the foot valve. The cable harness plug number is SE-11

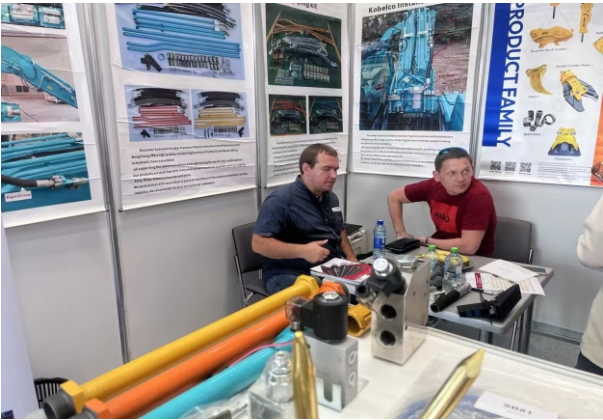

## Mengzhong Hydraulic Engineering Machinery Co. LTD

<http://www.mengzhongyy.com>

---

Jinan Mengzhong (Jinan) radiation North China  
Add: Jinan City Tianqiao District Bridge town Maojia village West Industrial Park

---

Hefei Mengzhong (Hefei) radiation East China region  
Add: Hefei Yaohai District Daxing Town Jianhua new Village Jianhua Pier No.1workshop

---

Nanning Mengzhong (Nanning) radiation South China region  
Add: No.15, Building 5, No.48-18 Youyi Road, Jiangnan District, Nanning, China

---

Chongqing Mengzhong (Chongqing) radiation southwest region  
Add: Baihai Road Industrial Park, Jiulongpo District, Chongqing

---

Tel/WhatsApp: +86 18700740000  
Mail: [mengzhong1@jiabopipe.com](mailto:mengzhong1@jiabopipe.com)  
Company: Mengzhong Hydraulic Engineering Machinery Co.LTD  
<https://gxjbgj.en.alibaba.comV>

---

