

Xuzhou Qiyang Machinery Co., Ltd.

RDATTACH

Product Detail Brochure



We focus on high standards and independent core design, adhere to quality and continuous innovation as our product concept, position our products based on customers and markets, take brand effect and superior quality as our product advantages, and take value for money and perfection as our product purpose to serve our customers.

Company Profile and Product Features

Company Profile:

Xuzhou Qiyang Machinery Co., Ltd. was established in 2013 and is an emerging engineering machinery and equipment R&D enterprise. The company is located in Xuzhou City, Jiangsu Province, China's engineering machinery base. It is a long-term partner of many large enterprises and well-known brands such as XCMG, LSH-CAT, COSCO, Hengli, Inner Mongolia Energy, Jidong, Julong Mining, Doosan, Yanmar, Wackerneuson, etc.

The company adheres to the customer-centric and market-oriented thinking, adheres to quality and continues to innovate. We firmly believe that product quality is the foundation of the survival of the enterprise, so we insist on putting product quality first in every production link; we firmly believe that customer needs are the direction of our efforts, so we insist that product design is always centered on the actual use of customers; we firmly believe that the market reputation is the greatest affirmation of the enterprise, so we insist on doing a good job of tracking services for each product.

We are willing to be your most trusted long-term partner!

Product features:

Focusing on high standards and independent core design, adhering to quality and continuous innovation as product concepts; positioning products based on customers and markets; taking brand effect and superior quality as product advantages; taking value for money and perfection as product purpose to serve customers.

Bucket

Heavy Duty —



Severe Duty —



Extreme Duty —



Sieve Bucket —

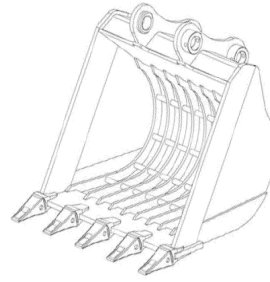

Tilt Bucket —

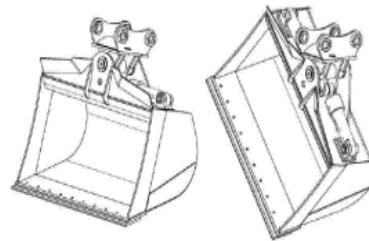

Ditch Cleaning Bucket —

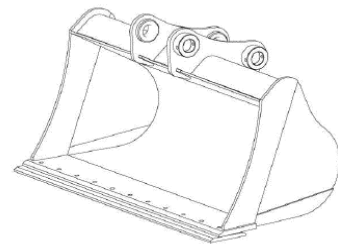

Trapezoidal Bucket —

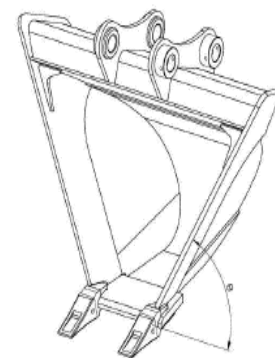

Rotary Screening Bucket——

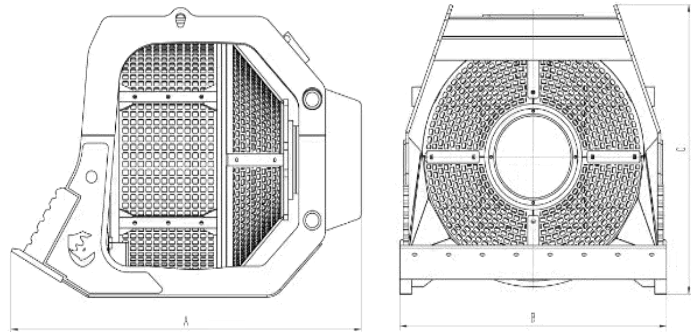

Horizontal Screening Bucket——



Shell Bucket——

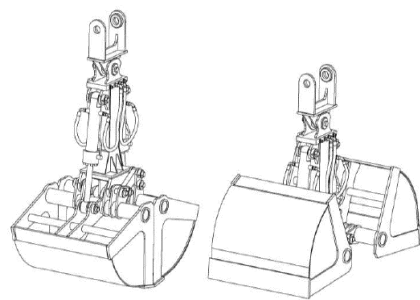

Rake——

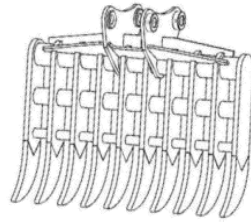

Jaw Crusher Bucket——



Ripper Bucket——



Vibratory Plant——



Clamp Bucket——

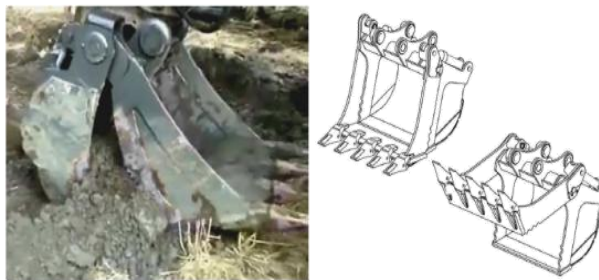

Thumb Clamp——



Double Cylinder Hydraulic Shear——



Ripper——

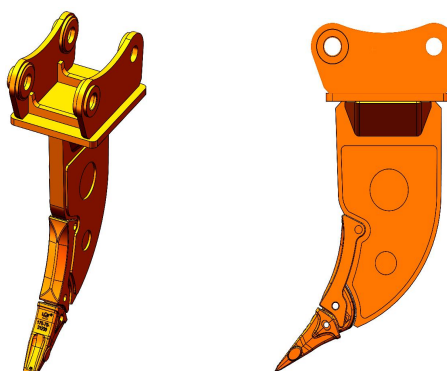

Compaction Wheel——

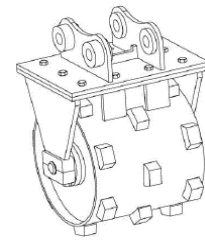

Mechanical Wood Clamp——

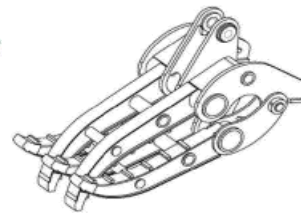
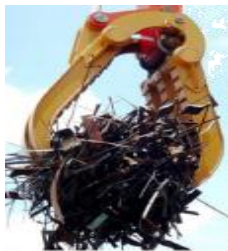

Orange Gripper——

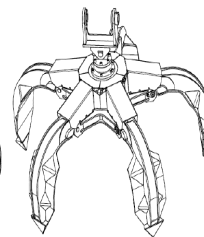
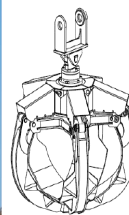
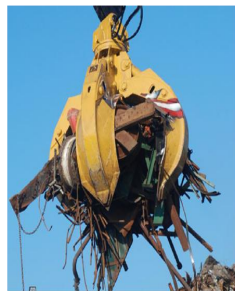

Milling and Excavation Machine——



Slide Bucket——



Heavy Loader Bucket——



Loader Bucket——



Road cleaning machine——

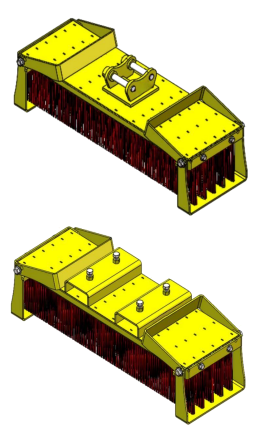

Hitach

Mechanical Quick Change



Hydraulic quick change



360° Rotating Quick Change



Tilt Quick Change



Forks

Adjustable Forks

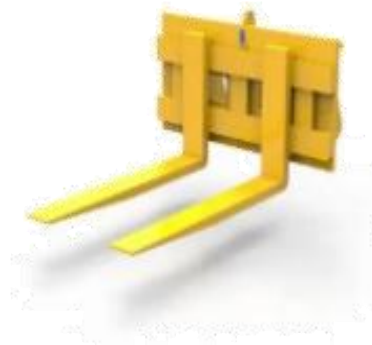

Quarry Block Forks



Hydraulic Circular Saws

Shrub Pruning Saw



Rock Saw



Pipe hanger

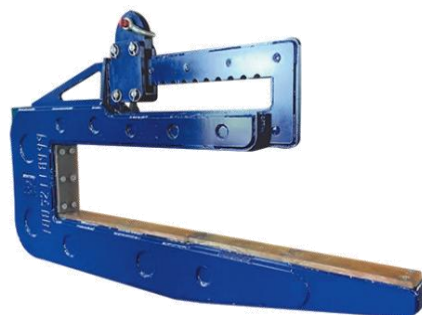

Lawnmower



徐州启洋机械有限公司

Xuzhou Qiyang Machinery Co., Ltd.

WhatsApp & WeChat: +86 18852118999

地址: 徐州市高新区长兴路5号

Address: No. 5 Changxing Road, Xuzhou High-tech Zone