



客服热线 | **0793-5226507**
HOTLINE

JIANGXI XINGUANG
DIAMOND TOOLS CO., LTD.

江西新光金刚石工具有限公司

江西新光金刚石工具有限公司

JIANGXI XINGUANG DIAMOND TOOLS CO., LTD.

地址：江西省上饶市鄱阳县田畈街工业园区007号

电话：0793-5226507

网址：www.singoon.com

邮箱：andy@chinaxinguang.com

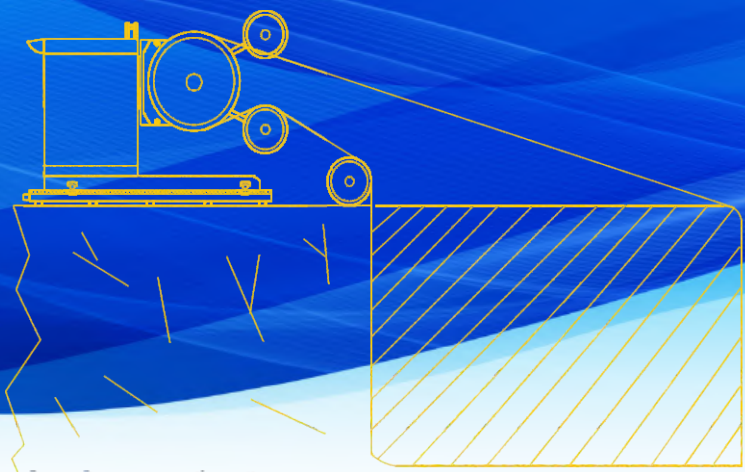
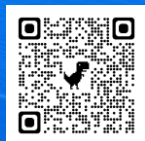

旋风转换器

竭诚为客户服务，欢迎来样品定制产品，洽谈业务



**JIANGXI XINGUANG
DIAMOND TOOLS CO., LTD.**

江西新光金刚石工具有限公司

Jiangxi Xinguang Diamond Tools Co., Ltd. was established in 2002, located in Tianfanjie Town, Poyang County, Jiangxi Province, covering an area of more than 27000 m2. The annual sales reach about 150 million RMB. Our main products are diamond wire saw machine, diamond wire saw, diamond segment, diamond saw blade and a series of stone cutting machine and tools. Our company is a diamond tool limited company integrating factories and trade. We have a number of national utility model patents and won the high-paying technology enterprise in 2021.

At present, the annual export volume accounts for about 30% of our company's turnover, and the products are exported to Europe, Central Africa, Asia, South America and other regions. We have a number of imported cold press machine, sintering machine and a series of excellent production equipment. We have high quality, good sales.

Our company on the basis of the "good quality, customer first" business philosophy, with the most perfect all-round service, and constantly improve the product quality. Xinguang is committed to providing customers with the best prices, the best timely delivery, the best reputation, and to establish an honest cooperation, to provide customers with the best products.



公司简介 Company Profile

江西新光金刚石工具有限公司成立于2002年，位于江西省鄱阳县田畈街境内，占地40余亩，年销售额达1.5亿左右。公司的主营产品为金刚石绳锯机，金刚石绳锯，金刚石刀头，金刚石锯片等一系列石材机械切割工具，是一家集工厂以及贸易一体化的金刚石工具有限公司，拥有多项国家实用新型专利并在2021年荣获高新技术企业。

目前产品年出口额占公司总营业额30%左右，产品远销于欧洲，中非，亚洲，南美洲等地区。公司拥有多台进口冷压机，烧结机等一系列精良的生产设备，产品品质高，销量好。公司立足于“品质优良、客户至上”的经营理念，用最完善的全方位服务，不断提高产品质量，以最优惠的价格、最及时的交货、最优良的信誉，建立起诚信合作，为客户提供最好的产品。

旋风转换器

CONTENTS

目录

01/	公司简介 COMPANY PROFILE	01/02
02/	产品介绍 PRODUCT INTRODUCTION	05/33
	矿山绳锯机 QUARRY WIRE SAW MACHINE	05/06
	钢混绳锯机 DIAMOND WIRE SAW MACHINE FOR REINFORCED CONCRETE	07/08
	花岗岩矿山绳锯 DIAMOND WIRE SAW FOR GRANITE QUARRYING	09/10
	大理石矿山绳锯 DIAMOND WIRE SAW FOR MARBLE QUARRYING	11/12
	钢筋混凝土绳锯 DIAMOND WIRE SAW FOR REINFORCED CONCRETE	13/14
	异形修边绳锯 DIAMOND WIRE SAW FOR PROFILING	15/16
	矿山刀头 DIAMOND SEGMENT FOR QUARRYING	17/18
	单片锯刀头 DIAMOND SEGMENT FOR SINGLE BLADE	19/20
	组合锯刀头 DIAMOND SEGMENT FOR MULTI BLADE	21/22
	国内组合锯刀头 DIAMOND SEGMENT FOR MULTI BLADE IN CHINA	23/24
	国内塔锯刀头 DIAMOND SEGMENT FOR MULTI BLADE IN CHINA	25/26

国内单片锯刀头 DIAMOND SEGMENT FOR SINGLE BLADE IN CHINA	27/28
花岗岩锯片 DIAMOND SAW BLADE FOR GRANITE	29
大理石锯片 DIAMOND SAW BLADE FOR MARBLE	30
岩板锯片 DIAMOND SAW BLADE FOR SINTERED STONE	31
混凝土锯片 DIAMOND SAW BLADE FOR CONCRETE	31
小切割片 SMALL DIAMOND SAW BLADE	32
水钻头 DIAMOND CORE DRILL BIT	33

03/	公司资质 COMPANY QUALIFICATION	34
04/	发展历程 DEVELOPMENT HISTORY	35/36
05/	厂房设备 WORKSHOP AND EQUIPMENT	37
06/	团队风采 TEAM STYLE	38
07/	我们的优势 OUR STRENGTHS	39/40
08/	展会 EXHIBITION	41/42

旋风转换器

产品介绍 Product introduction

矿山绳锯机

QUARRY WIRE SAW MACHINE



产品应用 APPLICATION



矿山绳锯机主要用于开采各种类型的石材如花岗岩、大理石、石英石、砂岩等，是石材矿山必不可少的机械。

Quarry wire saw machine is mainly used for cutting various types of stone materials such as granite, marble, quartz stone, sandstone, etc. It is an indispensable machine for stone mines.



产品参数 PRODUCT PARAMETER



型号 Model	55KW-6P	55KW-8P	永磁60KW	永磁70KW	75KW-6P
系统总功率(KW) Gross power of machine	59KW	59KW	64KW	74KW	79KW
主电机功率(KW) Power of main motor	55KW	55KW	60KW	70KW	75KW
串珠绳线速度 (M/S) Wire saw speed	0-40	0-33	0-40	0-40	0-40
可带绳长 (M) Length of wire	20-120	20-120	20-120	20-150	20-150
进给电机功率 (KW) feeding power	1.5KW	1.5KW	1.5KW	1.5KW	1.5KW
横移距离 (mm) Sideways range	560	560	560	560	560
旋转角度 Rotation angle	360°	360°	360°	360°	360°
设备行走速度 (m/h) Walking speed of machine	0-112	0-112	0-112	0-112	0-112
导轨长度 Length of rail (m)	2m*3+1m	2m*3+1m	2m*3+1m	2m*3+1m	2m*3+1m
使用许可温度 (°C) Working temperature range	-15°C ~ +40°C	-15°C ~ +40°C	-15°C ~ +40°C	-15°C ~ +40°C	-15°C ~ +40°C
电源 (AC V/Hz) Power	AC330V-420V, 50/60Hz				
整机重量 (T) Weight	2.8T	2.8T	2.6T	2.6T	3.2T

钢混绳锯机

DIAMOND WIRE SAW MACHINE
FOR REINFORCED CONCRETE



▶ 产品应用 APPLICATION



钢混绳锯机广泛用于混凝土楼板，桩基，支撑梁，柱，桥梁，地铁，水电大坝，水泥管道等的切割。

Diamond wire saw machine for reinforced concrete is widely used in the cutting of concrete floor slabs, pile foundations, support beams, columns, bridges, subways, hydroelectric dams, cement pipelines, etc.



▶ 产品参数 PRODUCT PARAMETER



型号 Model	18KW-6P	22KW-6P
系统总功率(KW) Gross power of machine	19	23
主电机功率(KW) Power of main motor	18	22
串珠绳线速度 (M/S) Wire saw speed	0-25	0-25
进给电机功率 (KW) Feeding power	0.2	0.2
行程距离 (mm) Move distance	1380	1380
设备行走速度 (m/h) Walking speed of machine	0-142	0-142
导轨长度 Length of rail (m)	2	2
使用许可温度 (°C) Working temperature range	-15°C ~ +45°C	-15°C ~ +45°C
电源 (AC V/Hz) Power	380V ± 5% 3P+N+E	380V ± 5% 3P+N+E
整机重量 (KG) Weight	368	388

旋风转换器

花岗岩矿山绳锯

DIAMOND WIRE SAW FOR
GRANITE QUARRYING



▶ 产品应用 APPLICATION



花岗岩矿山绳锯广泛应用于各类花岗岩矿山开采及荒料整形，具有切割效率高，污染小，成材率高，性价比高等特点。

Granite wire saws are widely used in various types of granite quarrying and block shaping, with high cutting efficiency, small pollution, high yield and high cost performance.



▶ 产品参数 PRODUCT PARAMETER



Application 应用场景	Size 尺寸	Reinforcement 固定方式	Beads/m 串珠	Stone Hardness 石材硬度	Line speed 线速度	Cutting Speed 锋利度	Life 寿命
Granite quarry 花岗岩矿山	11.5MM 12.5MM	Rubber 橡胶 Rubber+spring 橡胶+弹簧	40 PCS/M	Soft granite 软质花岗岩	25-35 M/S	12-20 M ² /H	12-16 M ² /M
				Mid-hard granite 中硬质花岗岩	25-35M/S	10-15 M ² /H	10-12M ² /M
				Hard granite 硬质花岗岩	25-30 M/S	8-12 M ² /H	8-10 M ² /M

大理石矿山绳锯

DIAMOND WIRE SAW FOR MARBLE QUARRYING



▶ 产品应用 APPLICATION



大理石矿山绳锯广泛应用于各类大理石矿山开采及荒料整形，具有切割效率高，污染小，成材率高，性价比高等特点。

Marble wire saws are widely used in various types of marble quarrying and block shaping, with high cutting efficiency, small pollution, high yield and high cost performance.



▶ 产品参数 PRODUCT PARAMETER



Application 应用场景	Size 尺寸	Reinforcement 固定方式	Beads/m 串珠	Stone Hardness 石材硬度	Line speed 线速度	Cutting Speed 锋利度	Life 寿命
Marble quarry 大理石矿山	11.5MM	Rubber 橡胶 Rubber+spring 橡胶+弹簧	40 PCS/M	Soft marble 软质大理石	30-40 M/S	10-18 M ² /H	20-25 M ² /M
				Mid-hard marble 中硬质大理石	30-40 M/S	10-16 M ² /H	15-20 M ² /M
				Hard marble 硬质大理石	30-40 M/S	8-12 M ² /H	10-15M ² /M

钢筋混凝土绳锯

DIAMOND WIRE SAW FOR
REINFORCED CONCRETE



▶ 产品应用 APPLICATION



钢筋混凝土绳锯广泛用于混凝土楼板，桩基，支撑梁，柱，桥梁，地铁，水电大坝，水泥管道等的切割。

Diamond Wire Saw for Reinforced Concrete is widely used in the cutting of concrete floor slabs, pile foundations, support beams, columns, bridges, subways, hydroelectric dams, cement pipelines, etc.



▶ 产品参数 PRODUCT PARAMETER



Application 应用场景	Size 尺寸	Reinforcement 固定方式	Beads/m 串珠	Stone Hardness 石材硬度	Line speed 线速度	Cutting Speed 锋利度	Life 寿命
Reinforced concrete 钢筋混凝土	10.5MM 11.5MM 12.5MM	Rubber+spring 橡胶+弹簧	40 PCS/M	Normal concrete 普通混凝土	22-28M/S	2-5M ² /H	2.5-3M ² /M
				Strong concrete 强混凝土	22-28M/S	1.5-3 M ² /H	1.5-2M ² /M

▶ 产品应用 APPLICATION



异形绳锯可用于各种石材的荒料整形、荒料分隔、弧形板加工及其他各种异形曲面加工等。

Diamond wire saw for profiling can be used for various stone block shaping, block separation, curved stone processing and other special-shaped surface processing.



异形修边绳锯

DIAMOND WIRE SAW FOR PROFILING



▶ 产品参数 PRODUCT PARAMETER



Application 应用场景	Size 尺寸	Reinforcement 固定方式	Beads/m 串珠	Stone Hardness 石材硬度	Line speed 线速度	Cutting Speed 锋利度	Life 寿命
Granite profiling 花岗岩异形切割	9.0MM	Plastic 塑胶	37 PCS/M	Soft granite 软质花岗岩	30-40 M/S	10-20 M ² /H	10-20M ² /M
				Mid-hard Granite 中硬质花岗岩	30-40 M/S	8-15M ² /H	8-15M ² /M
				Hard granite 硬质花岗岩	30-40 M/S	7-10M ² /H	7-10M ² /M
Marble profiling 大理石异形切割	9.0MM	Plastic 塑胶	37 PCS/M	Soft marble 软质大理石	30-40 M/S	20-30 M ² /H	30-40M ² /M
				Mid-hard marble 中硬质大理石	30-40 M/S	15-25M ² /H	25-35M ² /M
				Hard marble 硬质大理石	30-40 M/S	10-20M ² /H	20-30M ² /M

矿山刀头

DIAMOND SEGMENT
FOR QUARRYING



▶ 产品应用 APPLICATION



▶ 产品参数 PRODUCT PARAMETER



Diameter直径 (MM)	Length长度 (MM)	Width宽度 (MM)	Height高度 (MM)	Teeth no.齿数 (PCS)	Life寿命 (M ² /2片)	Speed锋利度 (M ² /天 (20-24小时))
φ2200小片 Small	22	13.2/13.8	14/15	132	350-600	180-250
φ3300大片 Big	22	11/11.6	14/15	160		
φ2400小片 Small	22	14/14.6	14/15	140		
φ3600大片 Big	22	12/12.6	14/15	170		
φ2400小片 Small	22	15/15.6	14/15	140		
φ3800大片 Big	22	13.2/13.8	14/15	180		

单片锯刀头

DIAMOND SEGMENT
FOR SINGLE BLADE



▶ 产品应用 APPLICATION



▶ 产品参数 PRODUCT PARAMETER



Diameter直径 (MM)	Length长度 (MM)	Width宽度 (MM)	Height高度 (MM)	Teeth no. 齿数 (PCS)
φ 350	40	3.2	12/15/20	24
φ 400	40	3.6	12/15/20	28
φ 450	40	4.2	12/15/20	32
φ 500	40	4.5	12/15/20	36
φ 600	40	5	12/15/20	42
φ 700	40	5.5	12/15/20	50
φ 800	40	6	12/15/20	58
φ 900	40/24	7/5.0/5.4	12/15/20	64
φ 1000	24	6.6/7.2	12/15/20	70
φ 1200	24	7.0/7.6	12/15/20	80
φ 1400	24	7.6/8.4	12/15/20	96
φ 1600	24	8.6/9.2	12/15/20	108
φ 1800	24	9.4/10	12/15/20	120
φ 2000	24	9.8/10.6	15/20/30	128
φ 2500	24	10.6/11.4	15/20/30	140
φ 3000	24	12/12.5	15/20/30	160
φ 3500	24	12.5/13	15/20/30	180

*我们也可以根据客户需要的规格定做

*We can also customize according to the specifications required by customers

组合锯刀头

DIAMOND SEGMENT
FOR MULTI BLADE



▶ 产品应用 APPLICATION



▶ 产品参数 PRODUCT PARAMETER



Blade thickness 锯片直径 (mm)	Length长度 (MM)	Width宽度 (MM)	Height高度 (MM)
5.5	24	6.8/7.4	13/15/20
6.5	24	7.6/8.4	13/15/20
7.2	24	8.4/9.0	13/15/20

▶ 产品应用 APPLICATION



国内组合锯刀头

DIAMOND SEGMENT FOR
MULTI BLADE IN CHINA



▶ 产品参数 PRODUCT PARAMETER



BLADE THICKNESS 锯片厚度 (MM)	Length长度 (MM)	Width宽度 (MM)	Height高度 (MM)	LIFE寿命 (M ² /粒)
6.5	24	7.8/8.4	12	1-1.5
	24	7.8/8.4	13/14	
	24	8.0/8.6	12	
	24	8.0/8.6	13/14	
7.2	24	8.4/9.0	12	
	24	8.4/9.0	13/14	
	24	8.6/9.2	12	
	24	8.6/9.2	13/14	

国内塔锯刀头

DIAMOND SEGMENT FOR
MULTI BLADE IN CHINA



▶ 产品应用 APPLICATION

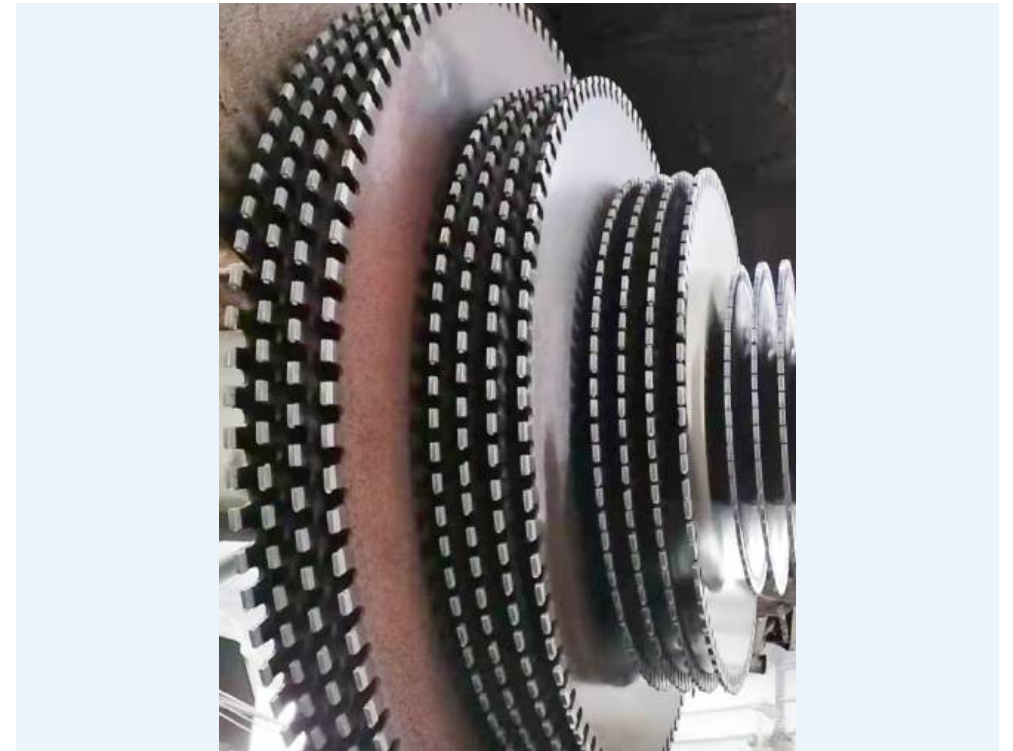

▶ 产品参数 PRODUCT PARAMETER



Blade thickness 锯片直径 (mm)	Length长度 (MM)	Width宽度 (MM)	Height高度 (MM)
4.5	24	5.8/6.4	12/13/14/15
5.5	24	6.8/7.4	12/13/14/15

▶ 产品应用 APPLICATION



国内单片锯刀头

DIAMOND SEGMENT FOR
SINGLE BLADE IN CHINA



▶ 产品参数 PRODUCT PARAMETER



Blade thickness 锯片直径 (mm)	Length长度 (MM)	Width宽度 (MM)	Height高度 (MM)	LIFE寿命 (M ² /片)
1600	24	8.4/9.0	12	150-250
	24	8.4/9.0	13/14	
	24	8.4/9.0	14/15	
	24	8.6/9.2	12	
	24	8.6/9.2	13/14	
	24	8.6/9.2	14/15	

花岗岩锯片

DIAMOND SAW BLADE
FOR GRANITE

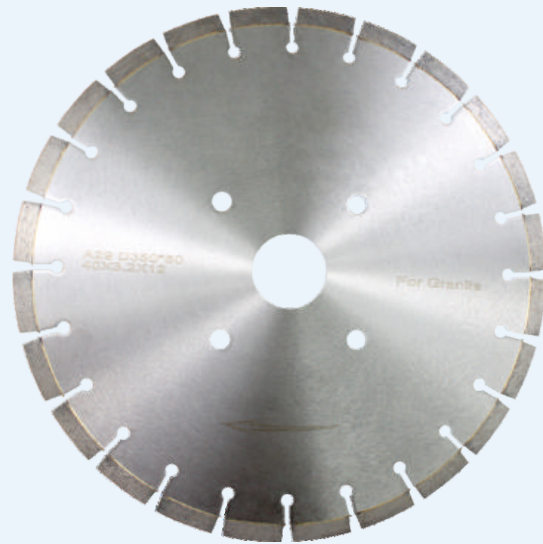

大理石锯片

DIAMOND SAW BLADE
FOR MARBLE

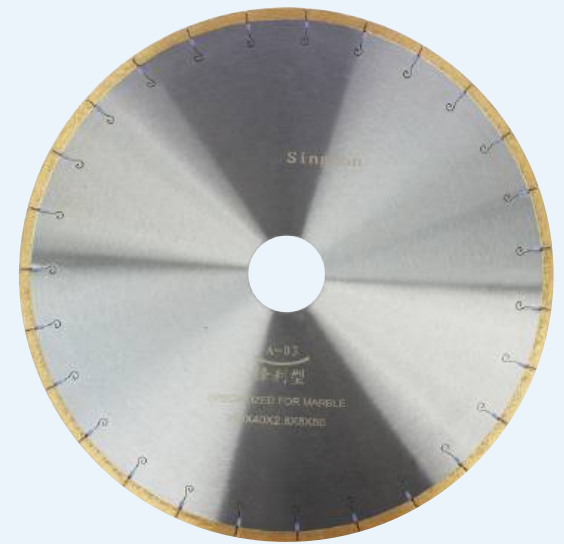

▶ 产品参数 PRODUCT PARAMETER



Diameter 直径 (MM)	Bore 孔径 (MM)	Segment dimension刀头规格 (MM)			Teeth no. 齿数 (PCS)	Matrix type 基体类型
		Length 长度	Thickness 厚度	Height 高度		
φ 300	50/60	40	3.0	10/12/15/20	22	Silent 静音/ Non-silent 普通
φ 350	50/60	40	3.2	10/12/15/20	24	Silent 静音/ Non-silent 普通
φ 400	50/60	40	3.6	10/12/15/20	28	Silent 静音/ Non-silent 普通
φ 450	50/60	40	3.8	10/12/15/20	32	Silent 静音/ Non-silent 普通
φ 500	50/60	40	4.2	10/12/15/20	36	Silent 静音/ Non-silent 普通
φ 600	50/60	40	4.8	10/12/15/20	42	Silent 静音/ Non-silent 普通

▶ 产品参数 PRODUCT PARAMETER



Diameter 直径 (MM)	Bore 孔径 (MM)	Segment dimension刀头规格 (MM)			Teeth no. 齿数 (PCS)	Matrix type 基体类型
		Length 长度	Thickness 厚度	Height 高度		
φ 300	50/60	40	3.0	8/10/12/15	22	Silent 静音/ Non-silent 普通
φ 350	50/60	40	3.2	8/10/12/15	24	Silent 静音/ Non-silent 普通
φ 400	50/60	40	3.6	8/10/12/15	28	Silent 静音/ Non-silent 普通
φ 450	50/60	40	3.8	8/10/12/15	32	Silent 静音/ Non-silent 普通
φ 500	50/60	40	4.2	8/10/12/15	36	Silent 静音/ Non-silent 普通
φ 600	50/60	40	4.8	8/10/12/15	42	Silent 静音/ Non-silent 普通

岩板锯片

DIAMOND SAW BLADE FOR
SINTERED STONE

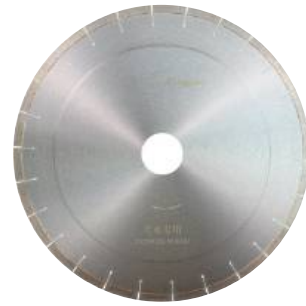

▶ 产品参数 PRODUCT PARAMETER



Diameter 直径 (MM)	Bore 孔径 (MM)	Segment dimension 刀头规格 (MM)		Teeth no. 齿数 (PCS)
		Thickness 厚度	Height 高度	
φ300	50	2.2	9	21
φ350	50	2.0	9	26

混凝土锯片

DIAMOND SAW BLADE
FOR CONCRETE



▶ 产品参数 PRODUCT PARAMETER



Diameter 直径 (MM)	Bore 孔径 (MM)	Segment dimension 刀头规格 (MM)			Teeth no. 齿数 (PCS)
		Length 长度	Thickness 厚度	Height 高度	
φ300	25.4/50	40	3.0	10/12/15	22
φ350	25.4/50	40	3.2	10/12/15	24
φ400	25.4/50	40	3.6	10/12/15	28
φ450	25.4/50	40	3.8	10/12/15	32
φ500	25.4/50	40	4.2	10/12/15	36
φ600	25.4/50	40	4.8	10/12/15	42

小切割片

SMALL DIAMOND SAW BLADE

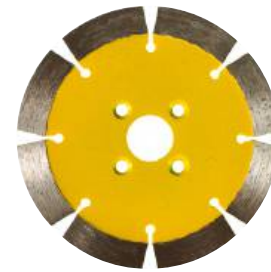

Size 尺寸 (MM)	Bore 孔径 (MM)	Cut 切割对象	Use type 使用方式
105Dx20Hx1.8Tx9W	20/22.23	Granite 花岗岩 Marble 大理石	Wet&dry 湿切&干切
114D × 12W × 1.8T	20/22.23		
φ125D × 8W × 2.2T	22.23		



Size 尺寸 (MM)	Bore 孔径 (MM)	Cut 切割对象	Use type 使用方式
114Dx2.0Tx15W	20/22.23	Granite 花岗岩 Marble 大理石	Wet&dry 湿切&干切
180Dx2.4Tx12W	25.4		



Size 尺寸 (MM)	Bore 孔径 (MM)	Cut 切割对象	Use type 使用方式
105Dx1.2Tx10W	20/22.23	Microlite 微晶 Ceramic 陶瓷	Wet&dry 湿切&干切
105Dx1.4Tx7W	20/22.23		



Size 尺寸 (MM)	Bore 孔径 (MM)	Cut 切割对象	Use type 使用方式
114Dx2.0Tx14W	20/22.23	Concrete 混凝土 Wall 墙	Wet&dry 湿切&干切

水钻头

DIAMOND CORE DRILL BIT



▶ 产品参数 PRODUCT PARAMETER



Diameter 直径 (MM)	Usefull length 有效长度 (MM)	Teeth height 刀头高度 (MM)	Teeth thickness 刀头厚度(MM)	Teeth no. 齿数 (PCS)
φ51	400/450	8/10	3.7	5
φ63	400/450	8/10	4.0	6
φ76	400/450	8/10	4.0	7
φ83	400/450	8/10	4.0	8
φ102	400/450	8/10	4.2	9
φ120	400/450	8/10	4.2	10
φ132	400/450	8/10	4.5	11
φ160	400/450	8/10	4.5	12
φ180	400/450	8/10	4.5	13
φ200	400/450	8/10	4.5	15
φ220	400/450	8/10	4.5	16
φ245	400/450	8/10	4.5	17
φ300	400/450	8/10	4.7	19

旋风转换器

公司资质 Company Qualification



D 发展历程 Development history

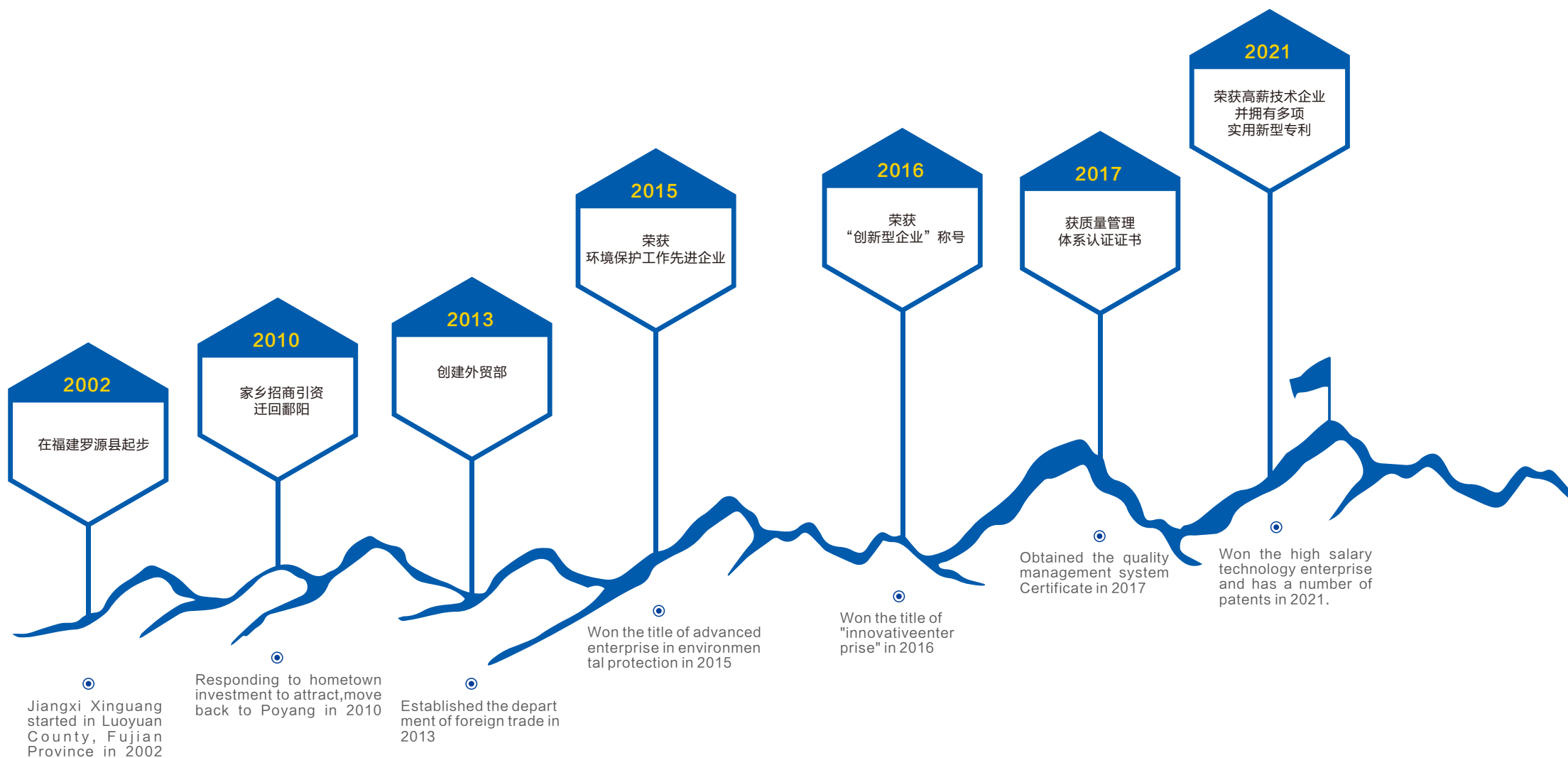

W 厂房设备 WORKSHOP AND EQUIPMENT



T 团队风采 Team style





我们的优势 Our strengths

自主生产与研发，
优秀的管理团队，
强大的执行力，
精准的营销能力，
丰富优质的产品。

Independent Production and R & D,
Excellent Management Team,
Strong Execution,
Accurate Marketing Ability,
Rich High-quality Products.

对客户用心 对产品创新

BE ATTENTIVE TO CUSTOMERS AND PRODUCT INNOVATION



展会 EXHIBITION



凝心聚力 创建未来
GATHER WISDOM TO CREATE THE FUTURE



JIANGXI XINGUANG
DIAMOND TOOLS CO., LTD.
江西新光金刚石工具有限公司