



株洲信达机械科技股份有限公司  
ZHUSHOU XINDA MACHINERY TECHNOLOGY CO., LTD

电话: 0731-22888117

网址: www.xdix66.com

地址: 湖南省株洲市天元区促进园A2栋

Address: Building A2,promotion Park,Tianyuan

District,zhuzhou City ,Hunan Paovince,



株洲信达机械科技股份有限公司  
ZHUSHOU XINDA MACHINERY TECHNOLOGY CO., LTD

# 掘进齿

ROUND SHANK BIT

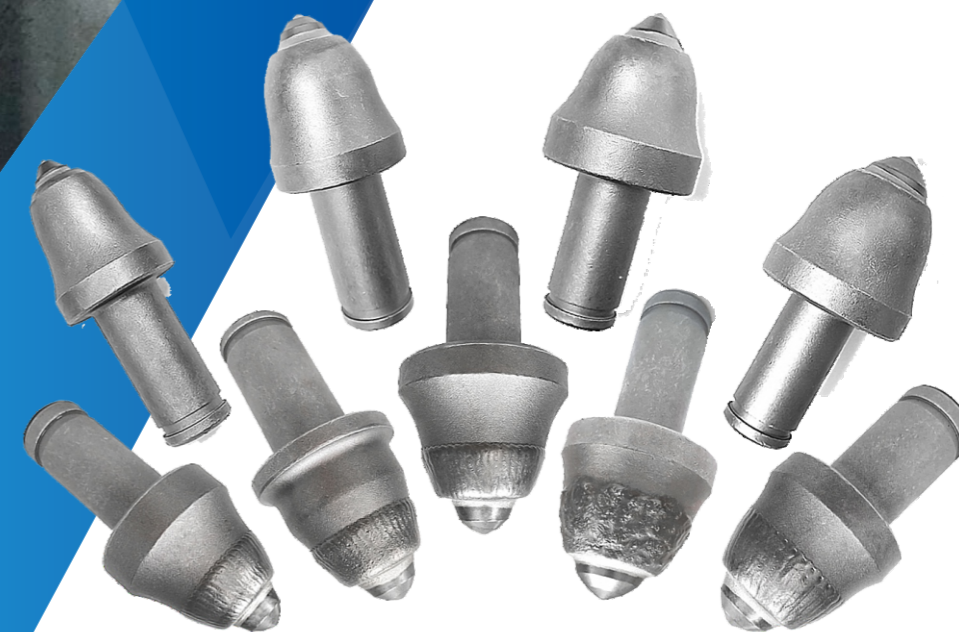



# 公司简介 COMPANY PROFILE

株洲信达机械科技股份有限公司（以下简称信达机械）成立于2017年，是一家专注截齿研发、生产、销售、服务为一体的高新技术企业，湖南省“专精特新”小巨人企业。公司坐落于亚洲最大的硬质合金生产基地——湖南株洲，注册资本1000万元，现有全自动智能截齿生产线2条，能够满足年产40万支截齿需求。公司拥有实用新型专利7项，发明专利2项（授权）。目前公司主要经营的产品有隧道掘进齿、矿山巷道掘进齿、煤矿采煤截齿，铁路、公路、机场等基础设施建设用旋挖齿等各类掘进零配件产品。

秉承“诚信致远，通达天下”的企业经营理念，公司对标国际头部企业，严控产品品质，历经数年和上万次测试，研发出了独特的“截齿超耐磨涂层”技术，完美解决了恶劣工况及超硬岩掘进问题，在业内形成了良好口碑。经过数百次实地测试，公司截齿产品切割效率和使用寿命显著高于普通截齿30%以上。

信达机械还积极与国内知名高校开展产学研合作。我们与中南大学材料学院、地球物理信息学院联合研究的“截齿-岩石耦合数值模拟系统”，能够根据客户岩石样本数据，精准预测耗齿量，为客户项目成本测算提供数据支撑，预测准确率达到90%以上。

目前，公司产品遍布国内各地，已经与众多煤业和工程机械央企、国企建立了长期合作关系。信达截齿也已经出口欧美、南美、东南亚及非洲等国家，为众多国际客户所青睐。2023年，信达机械正式面向全国，诚邀经销商和代理商加盟，携手共赢，共创未来。

Zhuzhou Xinda Machinery Technology Co., Ltd. (hereinafter referred to as Xinda Machinery) was established in 2017. It is a high-tech enterprise that focuses on the research and development, production, sales, and service of cutting teeth, and a "specialized, refined, and new" small giant enterprise in Hunan Province. The company is located in Zhuzhou, Hunan, the largest hard alloy production base in Asia, with a registered capital of 10 million yuan. It currently has two fully automatic intelligent cutting production lines, which can meet the annual production demand of 400000 cutting teeth. The company has 7 utility model patents and 2 invention patents (authorized). At present, the company's main products include tunnel excavation teeth, mining tunnel excavation teeth, coal mining picks, and various excavation spare parts products such as rotary excavation teeth for infrastructure construction such as railways, highways, and airports.

Adhering to the business philosophy of "integrity and openness to the world", the company targets international leading enterprises, strictly controls product quality, and after several years and tens of thousands of tests, has developed a unique "cutting ultra wear-resistant coating" technology, which perfectly solves harsh working conditions and ultra-hard rock excavation problems, and has formed a good reputation in the industry. After hundreds of on-site tests, the cutting efficiency and mission life of the company's cutting products are significantly higher than ordinary cutting teeth by over 30%.

Xinda Machinery also actively cooperates with well-known domestic universities in industry, academia, and research. We have collaborated with the School of Materials at Central South University and the School of Geophysical Information to develop a "pick rock coupling numerical simulation system" that can accurately predict tooth consumption based on customer rock sample data, providing data support for customer project cost estimation, with a prediction accuracy of over 90%.

At present, the company's products are distributed throughout China and has established long-term cooperative relationships with numerous central and state-owned enterprises in the coal industry and construction machinery. Xinda cutting teeth have also been exported to countries such as Europe, America, Southeast Asia, and Africa, and are favored by many international customers. In 2023, Xinda Machinery officially launched nationwide and sincerely invites dealers and agents to join us, working together for a win-win situation and creating a better future.

# 荣誉证书 CERTIFICATE OF HONOR

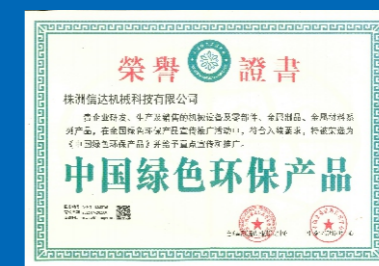
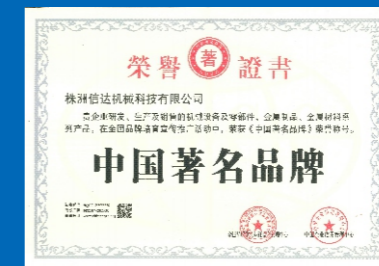



## 生产设备 PRODUCTION EQUIPMENT

该炉为链带式步进炉，适用于截齿的批量钎焊热处理。加热的工件采用红外线测温仪进行测量，具有自动化程度高、操作技术要求简便、控制精度高、工作环境好等特点。

The furnace is a chain belt walking furnace, which is suitable for batch brazing heat treatment of pick. The heated workpiece is measured by infrared thermometer. It has the characteristics of high automation, simple operation technology, high control precision and good working environment.

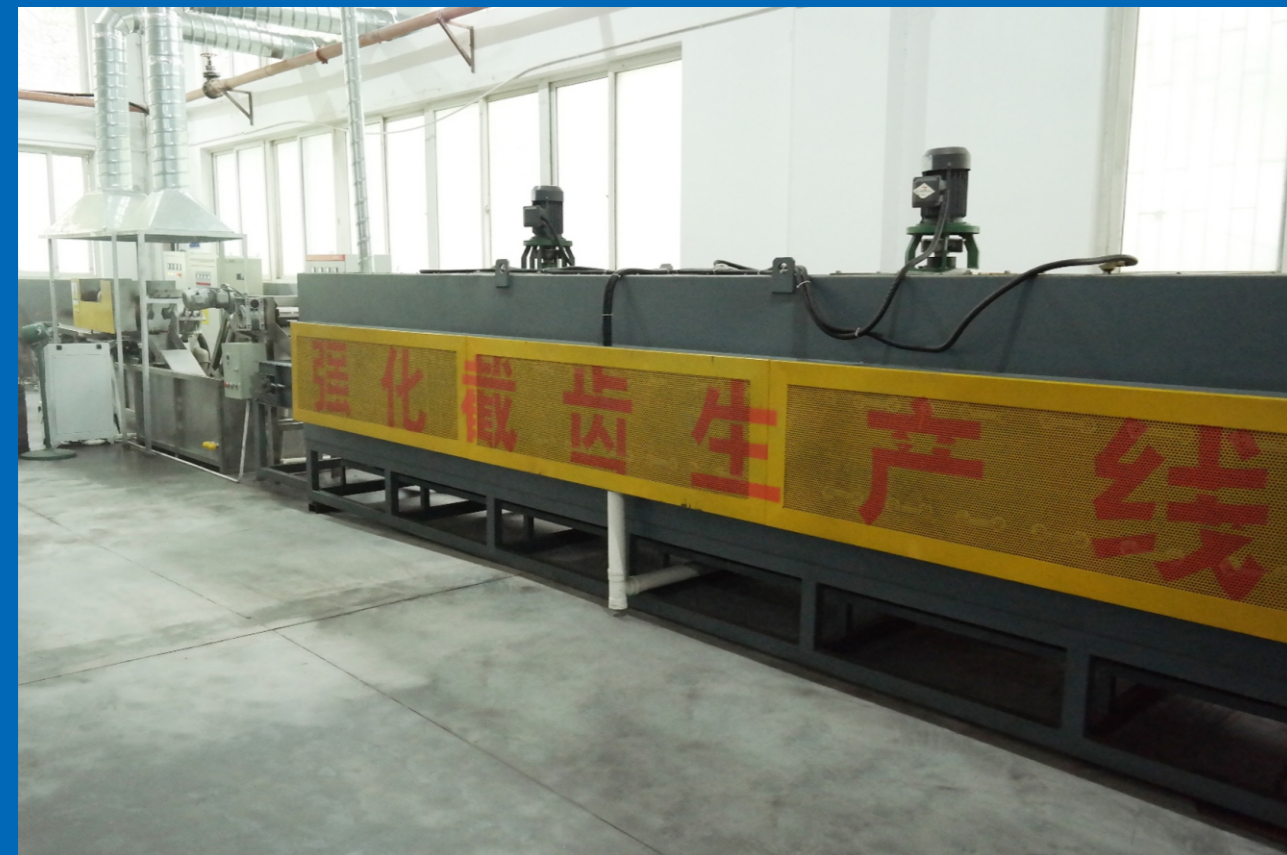

## 履带式抛丸机 Crawler Type Shot Blasting Machine

履带式抛丸机利用高速回转的叶轮，将弹丸抛向滚筒内连续翻转的工件上，达到清理的目的。它适合对各行各业中的小型铸件、锻件、冲压件等进行抛丸除锈、去除氧化皮和表面强化，特别适用于不怕碰撞的零件的表面清理及强化。

The crawler type shot blasting machine uses the high-speed rotating impeller to throw the shot in the cylinder, the workpiece is turned continuously to achieve the purpose of cleaning. It is suitable for small castings, forgings and stamping parts in various industries. It is especially suitable for shot blasting, scale removal and surface strengthening. It is used for surface cleaning and strengthening of parts that are not afraid of collision.



## 自动化堆焊设备 Automatic Surfacing Equipment

- 1、数字控制系统，多轴联动控制。
- 2、采用步进电机(可选伺服电机)运行稳定，精度高。
- 3、自动化程度高，堆焊过程一次完成，效率高。
- 4、系统稳定，抗干扰能力强。
- 5、可堆焊多种型号截齿及圆形工件。
- 6、小电流堆焊热影响小，钎焊合金头的截齿也可顺利堆焊，不影响钎焊层，不脱落。

1. Digital control system, multi axis linkage control.
2. Adopt step motor (optional servo motor) for stable operation and high precision.
3. High degree of automation, one-time completion of surfacing process, high efficiency.
4. Stable system and strong anti-interference ability.
5. Various types of cutting teeth and round workpiece can be hardfacing.
6. The heat effect of small current surfacing is small, and the pick of brazing alloy head can also be surfacing smoothly without affecting the brazing layer or falling off.







## 掘进齿产品详情 PRODUCT DETAILS

型号	XD22-38-64
合金直径大小d	φ22
总高H	157
齿体最大外径D	64
齿体柄部大小D1	38
齿体柄部高度H1	64

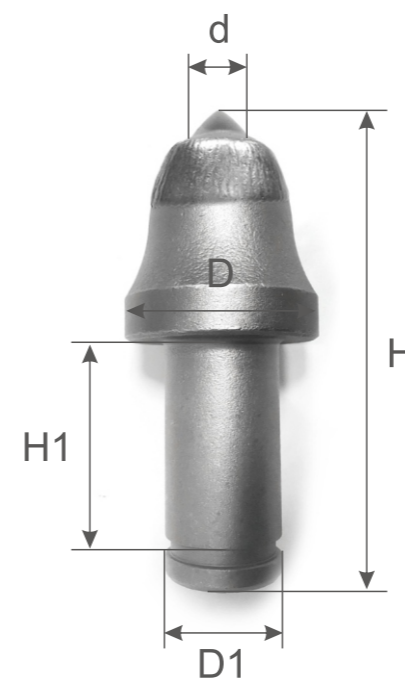
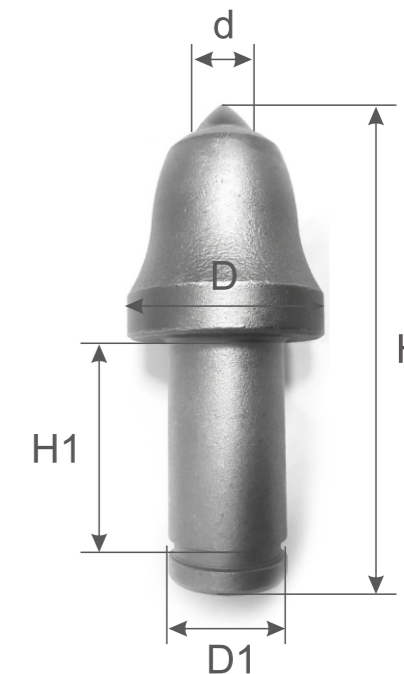

型号	XD22R-38-64
合金直径大小d	φ22
总高H	157
齿体最大外径D	64
齿体柄部大小D1	38
齿体柄部高度H1	64





型号	XD25-38-64
合金直径大小d	φ 25
总高H	159
齿体最大外径D	64
齿体柄部大小D1	38
齿体柄部高度H1	64

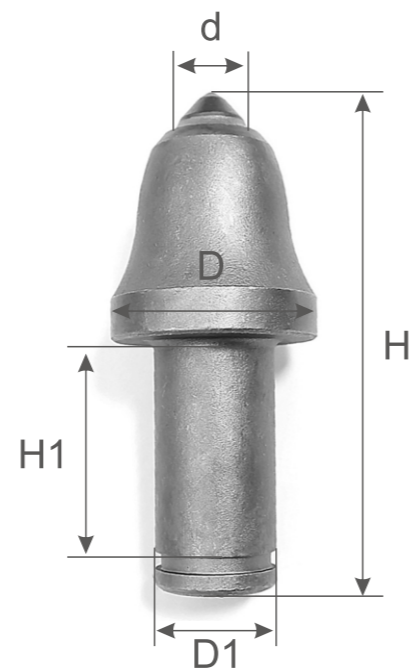

型号	XD25R-38-75A
合金直径大小d	φ 25
总高H	166
齿体最大外径D	75
齿体柄部大小D1	38
齿体柄部高度H1	64

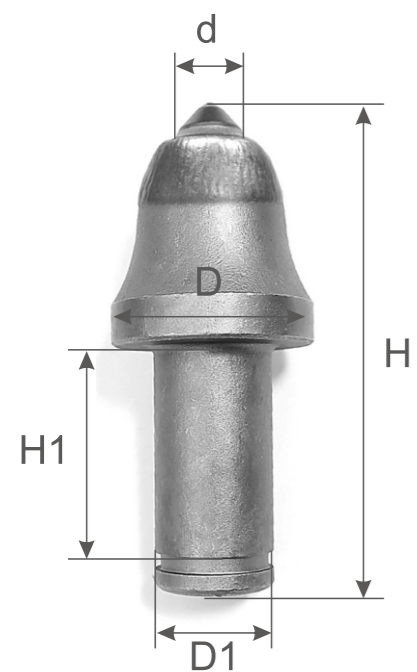
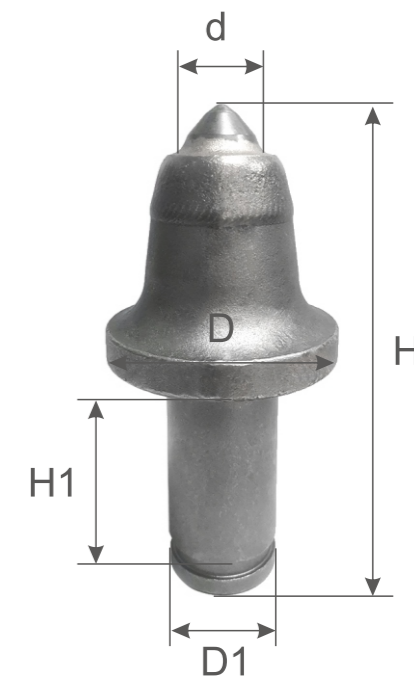

型号	XD25R-38-64
合金直径大小d	φ 25
总高H	159
齿体最大外径D	64
齿体柄部大小D1	38
齿体柄部高度H1	64

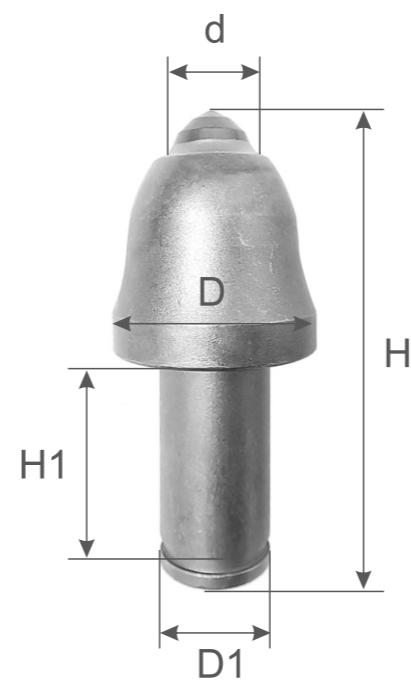

型号	XD30-38-68
合金直径大小d	φ 30
总高H	161
齿体最大外径D	68
齿体柄部大小D1	38
齿体柄部高度H1	64



型号	XD30R-38-68
合金直径大小d	φ30
总高H	161
齿体最大外径D	68
齿体柄部大小D1	38
齿体柄部高度H1	64

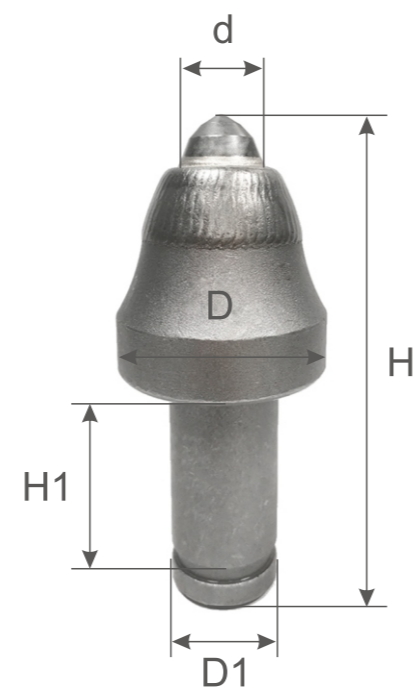

型号	XD30-38-75
合金直径大小d	φ30
总高H	163.2
齿体最大外径D	75
齿体柄部大小D1	38
齿体柄部高度H1	64

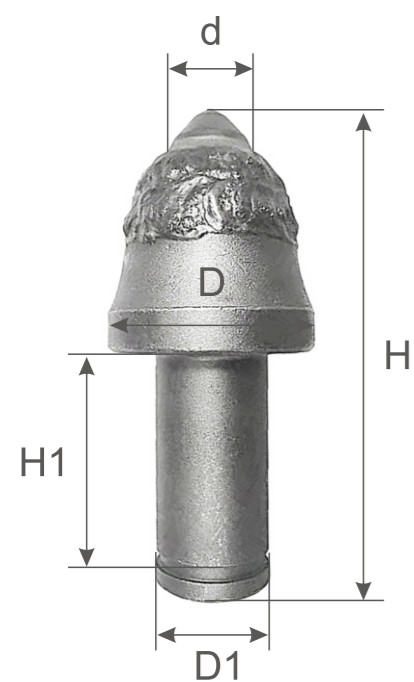
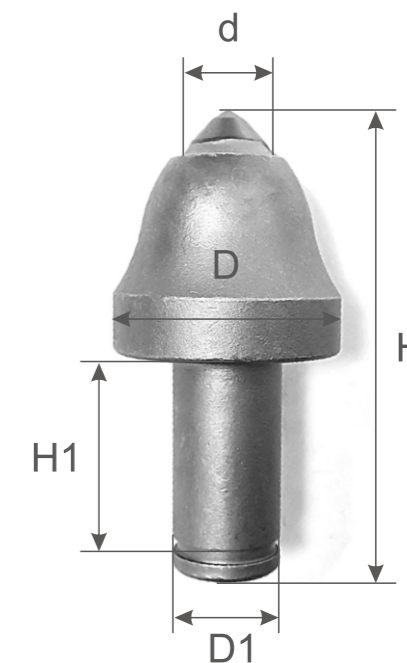

型号	XD30C-38-68
合金直径大小d	φ30
总高H	161
齿体最大外径D	68
齿体柄部大小D1	38
齿体柄部高度H1	64

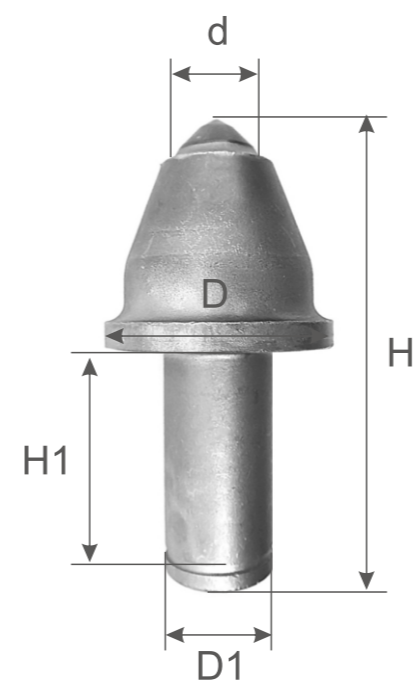

型号	XD30-38-75A
合金直径大小d	φ30
总高H	166
齿体最大外径D	75
齿体柄部大小D1	38
齿体柄部高度H1	64



型号	XD30R-38-75
合金直径大小d	φ30
总高H	163.2
齿体最大外径D	75
齿体柄部大小D1	38
齿体柄部高度H1	64

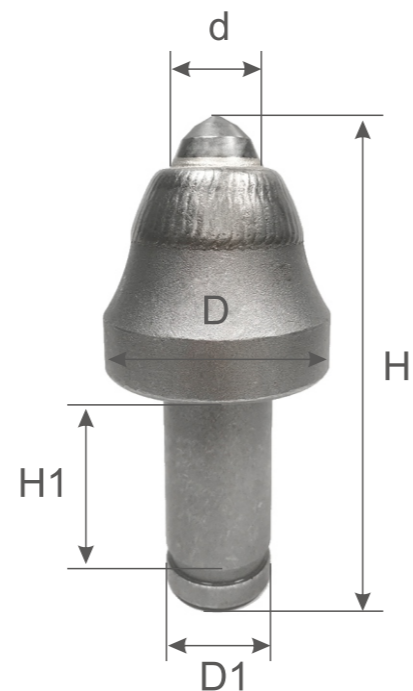

型号	XD30R-38-80
合金直径大小d	φ30
总高H	163.2
齿体最大外径D	80
齿体柄部大小D1	38
齿体柄部高度H1	64

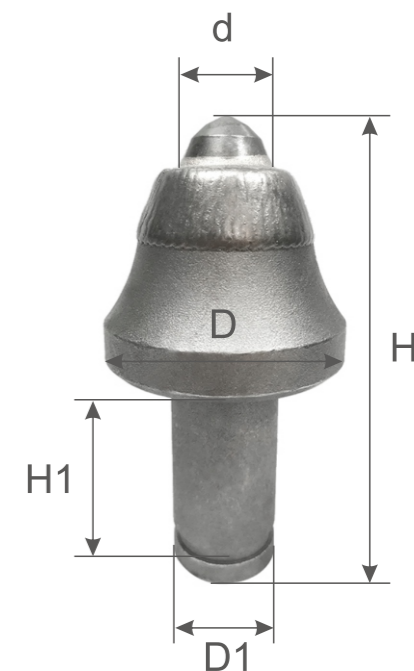

型号	XD30R-38-75A
合金直径大小d	φ30
总高H	166
齿体最大外径D	75
齿体柄部大小D1	38
齿体柄部高度H1	64

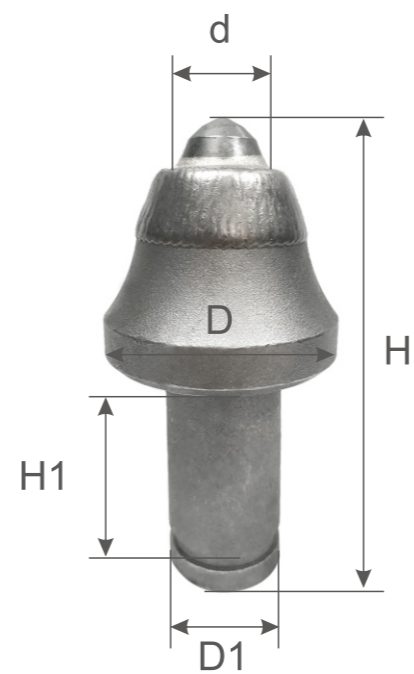

型号	XD30R-42-80
合金直径大小d	φ30
总高H	169.2
齿体最大外径D	80
齿体柄部大小D1	42
齿体柄部高度H1	70



型号	XD30C-38-75
合金直径大小d	$\phi 30$
总高H	163.2
齿体最大外径D	75
齿体柄部大小D1	38
齿体柄部高度H1	64

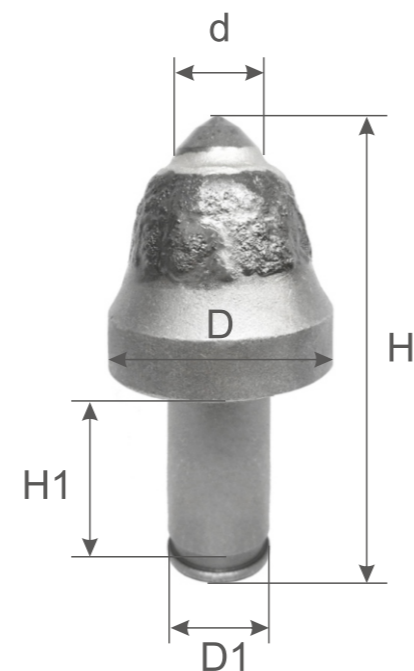

型号	XD30-42-75
合金直径大小d	$\phi 30$
总高H	169.2
齿体最大外径D	75
齿体柄部大小D1	42
齿体柄部高度H1	70

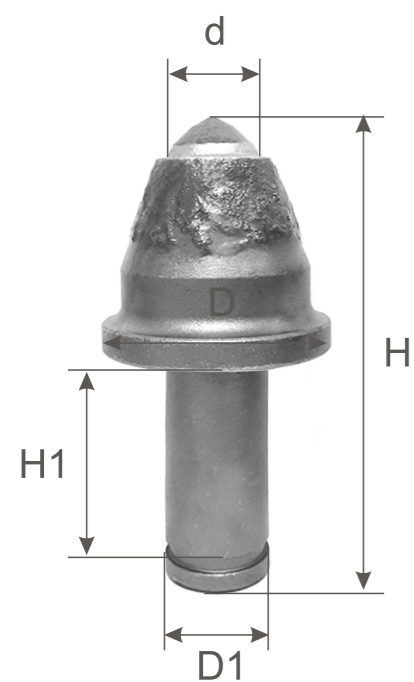
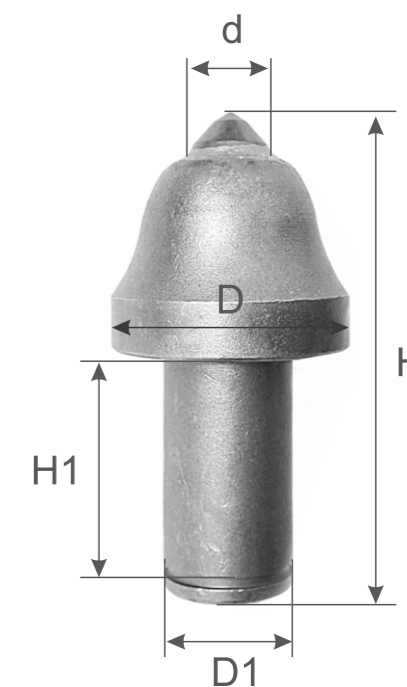

型号	XD30C-38-75A
合金直径大小d	$\phi 30$
总高H	166
齿体最大外径D	75
齿体柄部大小D1	38
齿体柄部高度H1	64

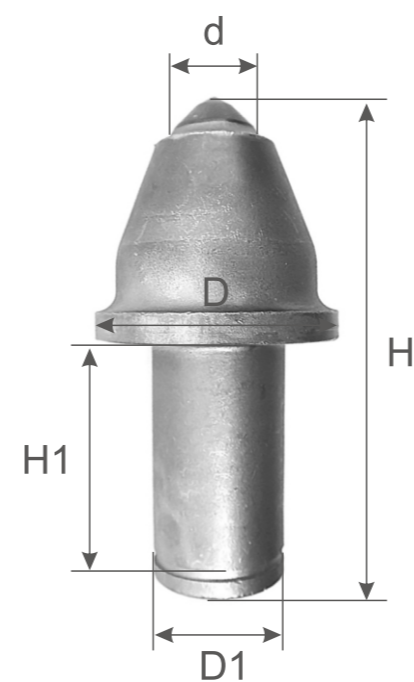

型号	XD30-42-75A
合金直径大小d	$\phi 30$
总高H	172
齿体最大外径D	75
齿体柄部大小D1	42
齿体柄部高度H1	70

型号	XD30R-42-75
合金直径大小d	$\phi 30$
总高H	169.2
齿体最大外径D	75
齿体柄部大小D1	42
齿体柄部高度H1	70

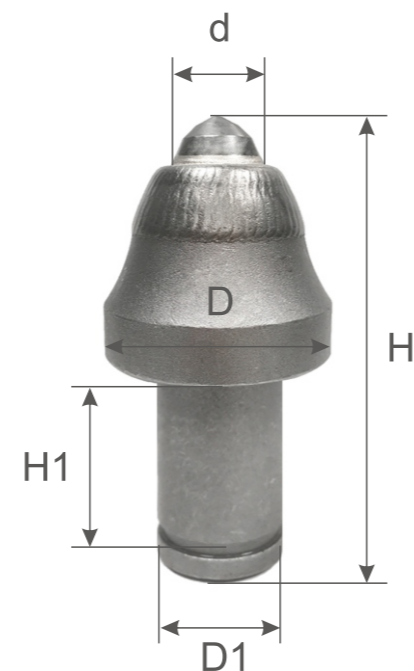

型号	XD30C-42-75
合金直径大小d	$\phi 30$
总高H	169.2
齿体最大外径D	75
齿体柄部大小D1	42
齿体柄部高度H1	70

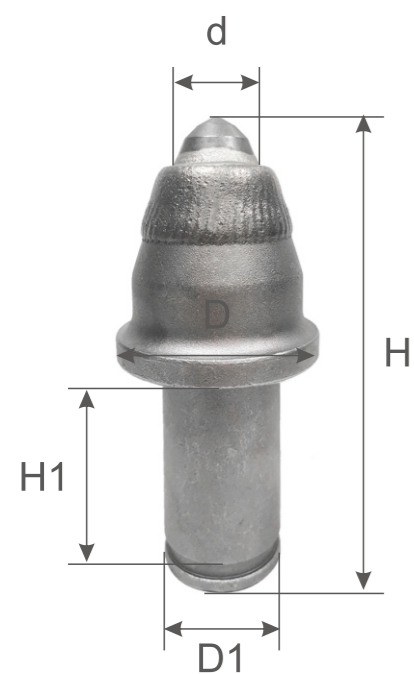
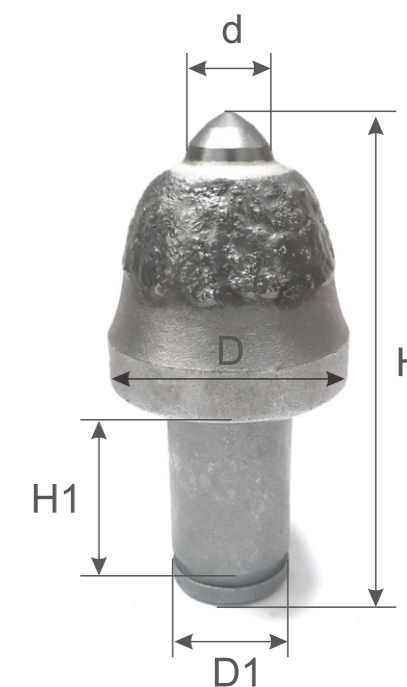

型号	XD30R-42-75A
合金直径大小d	$\phi 30$
总高H	172
齿体最大外径D	75
齿体柄部大小D1	42
齿体柄部高度H1	70

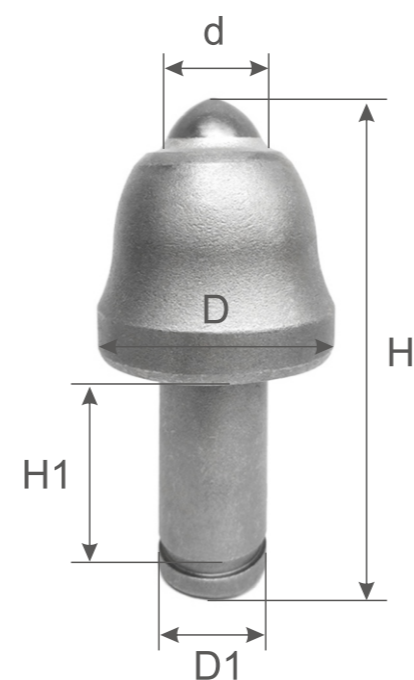

型号	XD32-38-75
合金直径大小d	$\phi 32$
总高H	163.5
齿体最大外径D	75
齿体柄部大小D1	38
齿体柄部高度H1	64



型号	XD32R-38-75
合金直径大小d	$\phi 32$
总高H	163.5
齿体最大外径D	75
齿体柄部大小D1	38
齿体柄部高度H1	64

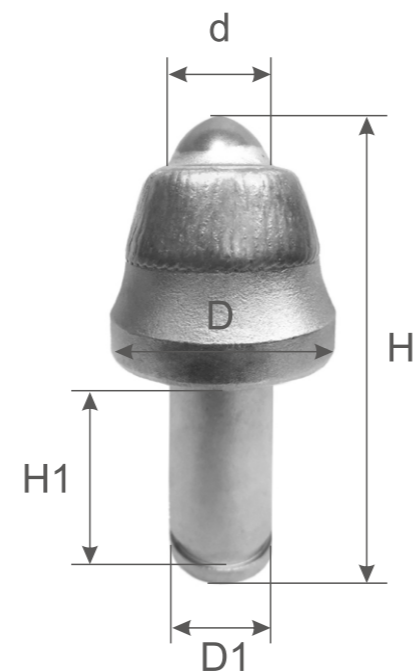

型号	XD35R-38-75
合金直径大小d	$\phi 35$
总高H	163.8
齿体最大外径D	75
齿体柄部大小D1	38
齿体柄部高度H1	64

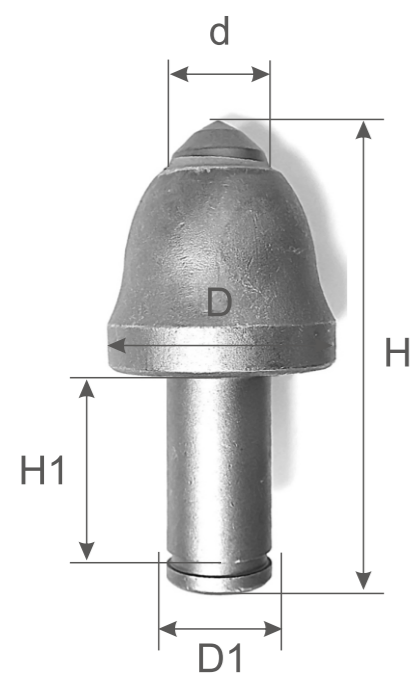
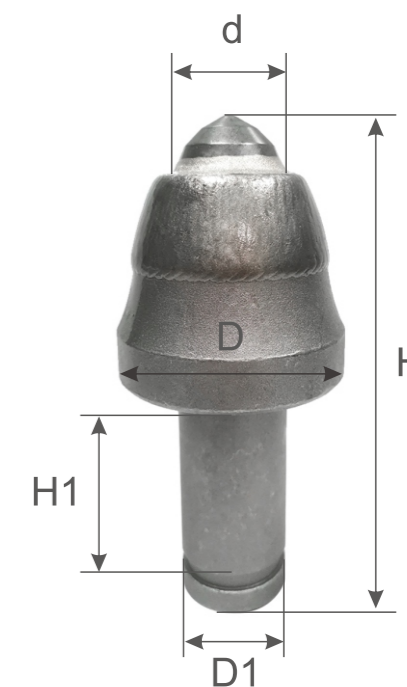

型号	XD35-38-75
合金直径大小d	$\phi 35$
总高H	163.8
齿体最大外径D	75
齿体柄部大小D1	38
齿体柄部高度H1	64

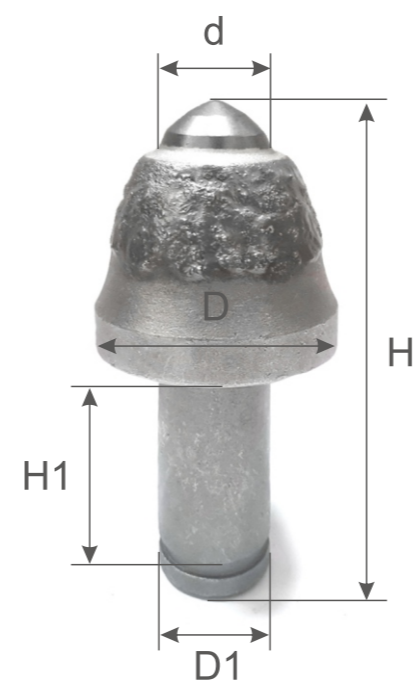

型号	XD35C-38-75
合金直径大小d	$\phi 35$
总高H	163.8
齿体最大外径D	75
齿体柄部大小D1	38
齿体柄部高度H1	64

型号	XD35-42-75
合金直径大小d	φ35
总高H	169.8
齿体最大外径D	75
齿体柄部大小D1	42
齿体柄部高度H1	70

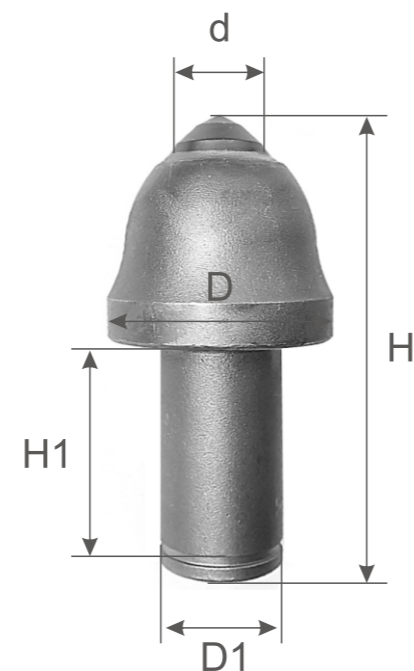

型号	XD35C-42-75
合金直径大小d	φ35
总高H	169.8
齿体最大外径D	75
齿体柄部大小D1	42
齿体柄部高度H1	70

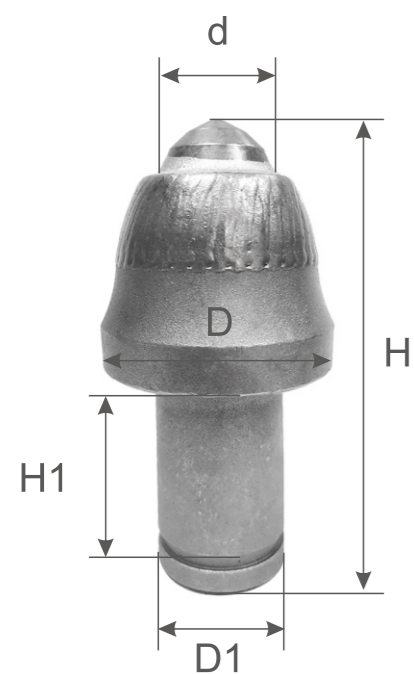
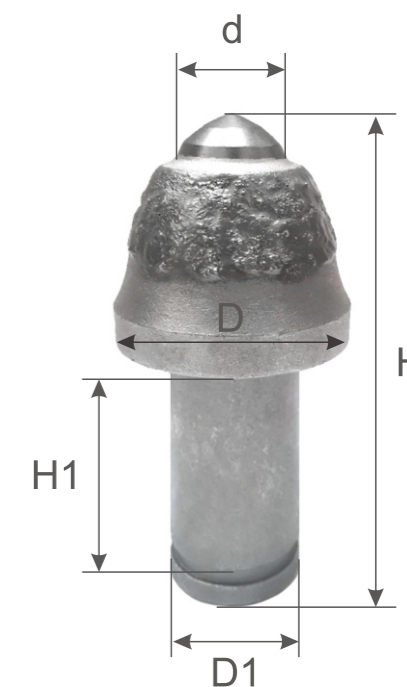

型号	XD35R-42-75
合金直径大小d	φ35
总高H	169.8
齿体最大外径D	75
齿体柄部大小D1	42
齿体柄部高度H1	70

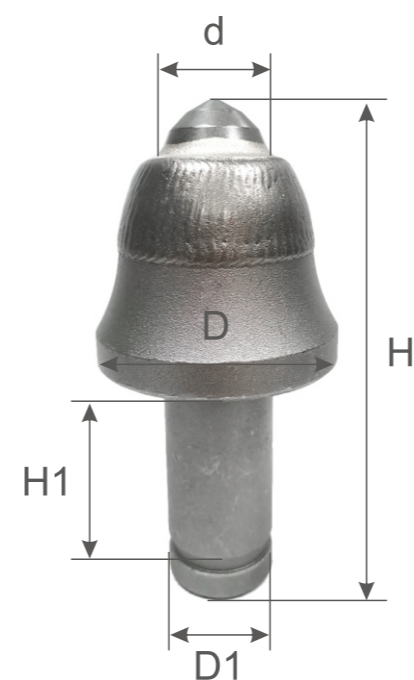

型号	XD35R-38-80
合金直径大小d	φ35
总高H	163.8
齿体最大外径D	80
齿体柄部大小D1	38
齿体柄部高度H1	64



# 原材料及包装箱展示

RAW MATERIAL&PACKING BOX



1 蓝色包装



2 黄色包装



3 红色包装

# 各种型号的齿座齿套

TOOTH SEAT



38齿座



S135-42齿座



S135-38齿座

# 现场应用展示

ON SITE APPLICATION DEMONSTRATION

