

2003-2023 逐梦百年

Reviewing the Twenty Years Journey and Thinking about Bright Future
忆往昔二十载风华 | 思未来百年之征程



浙江志高机械股份有限公司
地址:浙江省衢州市衢江区百灵北路15号
国内销售热线:0570-8089322 / 3375599 / 3375666
海外销售热线:0570-3688903 / 3379118
传真:0570-3375621
邮箱:zgjx@zhigaojx.com
网址:www.zhigaojx.com

Zhejiang Zhigao Machinery Co., Ltd.
Add: No.15 North Bailing Avenue, Qujiang District, Quzhou City, Zhejiang Province, China
Domestic Sales Hotline: +86-570-8089322 / 3375599 / 3375666
Overseas Sales Hotline: +86-570-3688903 / 3379118
Fax: +86-570-3375621
E-mail: zgjx@zhigaojx.com
Http: www.zhigaojx.com

20th
周年
ANNIVERSARY

二十风华茂

信任 / 理解 / 期待
Confidence + Understanding + Expectation



Be in 20th th

树立“百年大企”长远目标
踏上“2023-2033十年规划”全新征程·····

With the aspiration for becoming a time-honored brand,
Zhigao is embarking on a new journey of ten-year plan of 2023-2033.





■ 浙江志高机械股份有限公司是一家从事系列空气压缩机和凿岩设备的研究开发、生产销售和应用服务的专业厂家。产品广泛应用于工业气源、各类矿山开采和工程项目建设。企业以技术开发为核心，秉承“重细节、求高效、铸品质、创未来”的行动纲领，以“科技创新无限，志高掘进先锋”为经营理念。放眼全球，用争创世界一流的信心为客户提供产品和服务，为中国装备制造业的崛起和绿色矿山工程建设而努力前行！

■ Zhejiang Zhigao Machinery Co., Ltd. is a professional manufacturer engaged in the research and development, production, marketing and application services of full range of air compressors and rock drilling equipment. Products are widely used in industrial compressed air sources, various types of mining and civil engineering construction. With technological innovation as the core, Zhigao establishes its guiding principle of "emphasizing details, seeking efficiency, based on quality, and striving for the brighter future", and adheres business philosophy of "continuous improvement and pursuit of perfection". Zhigao is eyeing the global market with world-class products to create value for customers, and contributing to the prosperity of China's equipment manufacturing industry and the construction of green mine projects.

志存高远, 持之以恒!
Aim high and persevere!

20年累计 Accumulated over 20 years

Sales of drilling rigs
销售钻机
24,800
台

Sales of Air compressor
销售空压机
156,000
台

National patents
国家专利
80
项



- 2003年, 浙江志高机械有限公司在衢州成立, 租用500m²简易厂房,
- 开发完成系列工程活塞机、液压潜孔钻。
- Zhejiang Zhigao Machinery Co., Ltd. was established in Quzhou in 2003, rented a simple workshop of 500 m².
- Self-developed a series of reciprocating compressors and DTH hydraulic drilling rigs.

Cooperation 战略合作

客户/经销商/供应商/用户与社会
Customers/Distributors/suppliers/Users and Society

信任

Brand & Product 品牌&产品

打造行业内“中国第一, 世界一流”品牌

To be a leading brand in the domestic industry
and a world-class enterprise

A pivotal machinery
manufacturer of a great power

大国重器

- ◎ 品牌体系 | Brand system
- ◎ 精工制造 | Precision manufacturing
- ◎ 产品分类 | Product classification
- ◎ 核心技术 | Core technology



可靠

Applications & Services 应用&服务

构建可靠的应用及服务体系

Building a reliable application
and service system

Leading
in the industry

行业领先

- ◎ 应用领域 | Application area
- ◎ 应用案例 | Application Cases
- ◎ 解决方案 | Solution
- ◎ 配件服务 | Accessories service



理解

Development Journey 发展历程

“数”说20年/了解并理解志高

Reviewing the path of twenty years
/To know and understand Zhigao

Retrospect
the initial intention

回首初心

- ◎ 企业荣誉 | Corporate Honors
- ◎ 发展轨迹 | Development path
- ◎ 研发历程 | R&D process
- ◎ 行业发展 | Industry Development

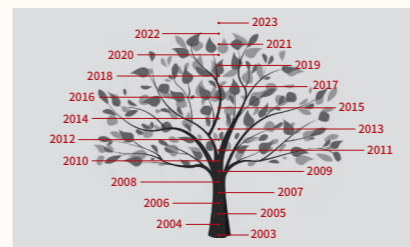

期待

Witness The Future 见证未来

面向未来/志高充满期待...

Going towards a bright future
/High expectations

Twenty
is in one's prime

20风华茂

- ◎ 创新创造未来 | Innovation creates the future
- ◎ 可持续发展 | Sustainable development
- ◎ 社会责任 | Social responsibility
- ◎ 人文风采 | Cultural charm





- 2004年购买衢江绿川北路26亩用地
- 开发完成系列潜孔钻、ZGYX2500钻车
- Y2004, purchased 4.28 acres of land on North Lvchuan Road, Qujiang District, Quzhou city.
- Self-developed a series of DTH drills, ZGYX2500 drill rig.

品牌体系

BRAND SYSTEM

志高掘进
ZHIGAOJUEJIN

工程通用产品

INDUSTRY
GENERAL
PRODUCTS

志高动力
ZHIGAODONGLI

工业节能产品

INDUSTRIAL
ENERGY-SAVING
PRODUCTS

ZEGA

全球高端产品

GLOBAL
PREMIUM
PRODUCTS

■ 国产化先锋

/ Pioneer of localization

■ 市场国际化

/ International Market

■ 自主创新品牌

/ Independent innovation

工程螺杆式空气压缩机

- 柴油移动式
- 柴油固定式
- 电动移动式
- 电动固定式

ZGYX系列露天钻机

- 分体式潜孔/锚固钻
- 分体式光伏/水井钻
- 一体式露天潜孔钻
- 一体式露天顶锤钻

工业通用系列空气压缩机

- SF/SFe单级
- SFeT双级变频
- WSFe水润滑无油
- SOe单级油冷变频
- SFHeT水平双变频

工业专用系列空气压缩机

- SFeD超低压
- CeT水泥专用
- SFeT双级低压
- SLe(T)激光切割
- ZSe螺杆无油鼓风机

工程螺杆式空气压缩机

- 柴油移动式
- 柴动撬装式
- 电动移动式
- 电动固定式

ZEGA系列露天钻机

- 露天分体式潜孔钻
- 露天一体式潜孔钻
- 露天一体式平台钻
- 露天一体式顶锤钻

ZEGA系列地下台车

- 地下单臂掘进台车
- 地下单臂锚杆台车
- 地下单臂采矿台车
- 地下多臂建筑台车

ZEGA·工业系列空压机

- ES单级立式螺杆机
- GS双级卧式螺杆机
- AS干式无油螺杆机
- ACM无油离心风机



Confidence from the brand comes from customer trust

来自品牌的信心 源于客户的信任



- 2005年在绿川北路新建5000m²新厂房并投入使用
- 开发完成电固螺杆式空压机、ZGYX3500钻车
- Y2005,the new workshop of 5000m²on North Lvchuan Road came into service.
- Self-developed electric power stationary screw air compressors, ZGYX3500 drill rig.

精工制造 A

Precision manufacturing

志高机械**第一工业园**，坐落于百灵北路15号，占地面积14.7万m²，建筑面积达11.1万m²，于2015年全面建成并投入使用，负责各种凿岩设备的研发及生产。Zhigao Machinery First Industrial Park is located at No. 15 North Bailing Road, covering an area of 147000 square meters and a building area of 111000 square meters. It was fully completed and put into use in 2015, responsible for the research and development and production of various rock drilling equipment.



第一工业园
1st Industrial Park





- 2006年绿川北路新建8000m²新厂房并投入使用
- 开发完成ZGYX2600钻车、132柴油移动螺杆式空压机
- Y2006, the new workshop of 8000m² on North Lvchuan Road came into service.
- Self-developed ZGYX2600 drill rig, 132 diesel mobile screw air compressor.

精工制造 B

Precision manufacturing

为响应国家“节能减排”号召，2020年志高股份投入巨资，打造了具备10亿产能规模的“节能空气压缩机”制造基地——志高动力**第二工业园**。该厂区占地8万m²，建筑面积达5.8万m²。厂区配有加工中心、高端磨床、高精度三坐标等先进加工及检测设备，为凿岩机、螺杆主机等高精密零件的制造保驾护航。In response to the national call for "energy conservation and emission reduction", in 2020, Zhigao Group invested heavily in building a "energy-saving air compressor" manufacturing base with a production capacity of 1 billion yuan - Zhigao Power **Second Industrial Park**. The factory covers an area of 80000 square meters, with a building area of 58000 square meters. The factory area is equipped with advanced processing and testing equipment such as machining centers, high-end grinding machines, and high-precision three coordinate machines, providing capability for the manufacturing of high-precision components such as rock drills and screw air ends.





- 2007年购买百灵北路74亩用地，新建1号厂房12000m²并投入使用
- 开发完成移动螺杆式空压机、ZGYX4500/5500/6500全液压一体钻车
- Y2007, purchased 12.19 acres of land on North Bailing Road, Qujiang District, Quzhou city; the new no.1 workshop came into service.
- Self-developed mobile screw air compressor, ZGYX4500/5500/6500 full hydraulic integrated drill rig.

精工制造 C

Precision manufacturing

志高机械**第三工业园区**——铆焊厂区，是在大型露天钻机及地下钻机销售量迅速增长的新形势下，公司为提升制造产能，提高资源利用率，对铆焊生产要素进行的整合规划。该厂区占地3万m²，建筑面积1.9万m²。Zhigao Machinery Third Industrial Park - Fabrication factory is a high-efficient precision cutting and welding process to enhance manufacturing capacity to meet the market situation of rapid growth in sales of large surface and underground drill rigs. The factory covers an area of 30000 square meters, with a building area of 19000 square meters.

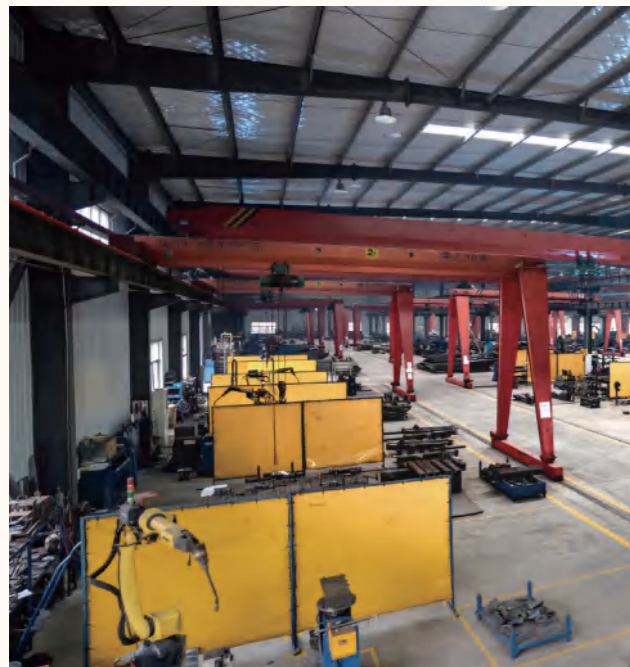

第三工业园
3rd Industrial Park





- 2008年,百灵北路新建2号厂房15000m²并投入使用
- 开发完成全系列螺杆空压机及分体钻机、520、460、660一体钻车
- 被评为“浙江省先进制造业基地”
- Y2008,the new no.2 workshop of 15000m² on North Bailing Road came into service.
- Self-developed a full range of screw air compressors and separated drill rigs,520/460/660 integrated drill rigs.
- Awarded as the advanced manufacturing base in Zhejiang Province



NO.01 产品品类分析 Product category

工业螺杆式
Industrial screw
空气压缩机
air compressor
志高动力
ZHIGAO TECH

工业 Z E G A 系列 Industrial Screw Air Compressor of ZEGA

<p>ES 喷油单级立式螺杆机 ES oil injection single stage vertical screw compressor</p> <p>功率 Power Range: 22-90 kW 额定压力 Work Pressure: 7 bar</p> 	<p>AS 干式无油螺杆机 AS dry oil-free screw compressor</p> <p>功率 Power Range: 55-250 kW 额定压力 Work Pressure: 8/10 bar</p> 
<p>GS 喷油双级卧式螺杆机 GS oil injection two-stage horizontal screw compressor</p> <p>功率 Power Range: 55-450 kW 额定压力 Work Pressure: 5/7 bar</p> 	<p>ACM 无油离心风机 ACM oil-free centrifugal blower</p> <p>功率 Power Range: 55-450 kW 额定压力 Work Pressure: 5/7 bar</p> 

工业通用系列

<p>SF/SFe 工频/变频空压机 SF/SFe power/variable frequency air compressor</p> <p>功率 Power Range: 7.5-132 kW 额定压力 Work Pressure: 8 bar</p> 	<p>WSFe 水润滑无油空压机 WSFe dry oil-free screw compressor</p> <p>功率 Power Range: 15-75 kW 额定压力 Work Pressure: 8 bar</p> 
<p>SOe 单级油冷变频空压机 SOe single stage oil cooled variable frequency air compressor</p> <p>功率 Power Range: 7.5-75 kW 额定压力 Work Pressure: 8 bar</p> 	<p>SFeT 双级变频空气压缩机 SFeT dual stage variable frequency air compressor</p> <p>功率 Power Range: 22-220 kW 额定压力 Work Pressure: 8/7 bar</p> 

工业专用系列

<p>SFeD/SFeT 低压螺杆机 SFeD/SFeT low-pressure screw compressor</p> <p>功率 Power Range: 37-250 kW 额定压力 Work Pressure: 1.5/3/3.5/4.5/5.5 bar</p> 	<p>CeT 水泥专用空气压缩机 CeT cement dedicated air compressor</p> <p>功率 Power Range: 55-250 kW 额定压力 Work Pressure: 6 bar</p> 
<p>SLe(T) 激光切割专用 SLe(T) laser cutting dedicated</p> <p>功率 Power Range: 15-55 kW 额定压力 Work Pressure: 16/20 bar</p> 	<p>ZSe 螺杆无油鼓风机 ZSe screw oil-free blower</p> <p>功率 Power Range: 37-132 kW 额定压力 Work Pressure: 1.2 bar</p> 



- 2009年,百灵北路新建3号成品库6000m²并投入使用
- 开发完成510、451钻车
- 一体钻机被经信委评为“装备制造重点领域首台(套)产品”
- Y2009,the new no.3 finished products warehouse of 6000m² on North Bailing Road came into service.
- Self-developed 510/451 drill rigs.
- The integrated drill rig was awarded as the first unit (set) product in the key areas of equipment manufacturing sector by Ministry of Industry and Information Technology.

NO.02 产品品类分析 Product category



工程螺杆式
Engineering screw

空气压缩机
air compressor

柴油动力
Diesel power

电动力
Electric power

移动式 Mobile

- 国二动力 Engine China II :
玉柴 Yuchai/锡柴 Xichai/康明斯 Cummins
- 国三动力 Engine China III :
玉柴 Yuchai/锡柴 Xichai/康明斯 Cummins
- 国四动力 Engine China IV :
玉柴 Yuchai/锡柴 Xichai/康明斯 Cummins
- 排气压力 Pressure :
7-36 bar
- 油箱容量 Diesel Tank Volume :
65-1200 L

固定撬装式 Box Utility

- 国二动力 Engine China II :
康明斯 Cummins/玉柴 Yuchai/锡柴 Xichai
- 国三动力 Engine China III :
康明斯 Cummins/玉柴 Yuchai/锡柴 Xichai
- 国四动力 Engine China IV :
玉柴 Yuchai /康明斯 Cummins/锡柴 Xichai
- 排气压力 Pressure :
18-36 bar
- 油箱容量 Diesel Tank Volume :
230-1200 L

移动式 Portable

- 电机功率 Electric Motor Power :
15-315 kW
- 主机排量 Capacity FAD :
2.8-39 m³/min
- 排气压力 Pressure :
8/12/14.5/18/24 bar
- 电机防护等级 Motor Protection Class :
IP54
- 一级压缩/二级压缩
Single/Two Stage Compression

固定式 Stationary

- 电机功率 Electric Motor Power :
55-220 kW
- 主机排量 Capacity FAD :
9.8-44 m³/min
- 排气压力 Pressure :
8 bar
- 电机防护等级 Motor Protection Class :
IP54
- 一级压缩/二级压缩
Single/Two Stage Compression





- 2010年, 购买百灵北路相邻63亩用地及地上建筑15600m², 与原厂区连成整体
- 开发完成450钻车
- 钻车产业化项目被科技部列入“国家火炬计划”、被评为“国家高新技术企业”
- Y2010,purchased 10.37 acres of land adjacent to North Bailing Road, and a building of 15600m², which were integrated into a whole with the former plant area.
- Self-developed 450 drill rig.
- Industrialized project on drill rigs was included in the National Torch Program by Ministry of Science and Technology; Zhigao was awarded as the National High-tech Enterprise.

NO.03 产品品类分析 Product category





- 2011年,百灵北路新建14500m²厂房并投入使用
- 在原有螺杆机产品中细分SF、SCF、SKF固定式螺杆空压机,2轮、4轮移动式螺杆空压机,品种达到近百个(螺杆机产品细分为六大系列,近百个品种)
- 履带式露天钻机国家行业标准起草制定单位
- Y2011,the new workshop of 14500m² on North Bailing Road came into service.
- Further classified as SF/SCF/SKF stationary, 2-wheel and 4-wheel mobile air compressor (divided into six categories with nearly 100 varieties).
- Drafting and formulating unit of national industry standards on surface crawler rig.

NO.04 产品品类分析 Product category

ZEGA 工程
Engineering open

露天钻机
-pit drilling rig



分体钻机
Separated



潜孔 钻机
Integr -ated



顶锤钻机
Top hammer Drill Rig





- 2012年,新办公楼5000m²建设完成并投入使用
- 开发完成300型水井钻机、HS3500夯实机
- 获“浙江省企业技术中心”、“浙江名牌”
- Y2012,new office building of 5000m² came into service.
- Self-developed 300 water well drilling rig,HS3500 rammer compactor.
- Awarded as Enterprise Technology Center in Zhejiang Province, Famous Brand in Zhejiang Province.

NO.05 产品品类分析 Product category

ZGYX/ZEGA 地下台车
Underground rig

单臂台车
One-boom Face Rig

多臂台车
Muti-boom Face Rig

掘进
DRILLING

锚杆
BOLTING

采矿
MINING

建筑
CONSTRUCTION

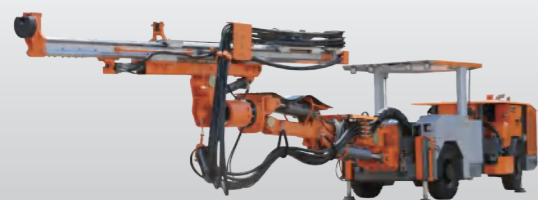

ZEGA UJ18A



ZEGA UM21K



ZEGA UP31B



ZEGA UJ33



ZEGA UJ21D



ZEGA UJ21MG



ZEGA UJ22



- 2013年, 志高第一工业园前期全面落成, 总占地面积140亩、建筑面积70000m²
- 开发完成200型水井钻和288、406重型柴油螺杆式空压机(钻机410/420/430三大系列, 近二十个品种覆盖所有分体钻机的客户需求)
- 获浙江省著名商标
- Y2013,the first phase of Zhigao industrial park was completed, with a floor area of 23 acres and building area of 70000m².
- Self-developed 200 water well drilling rig, 406 heavy duty diesel air compressor (three primary series of 410/420/430 drill rigs, over 20 types of separated drill rigs in total met demands of all the customers).
- Famous Brand in Zhejiang Province.

效率高 HIGH EFFICIENCY

根据细长活塞原理特性进行设计, 在相同冲击功率下可实现最大穿孔效率, 同时还可减小对钻具的损伤。Designed based on the principle and characteristics of slender pistons, maximum perforation efficiency can be achieved under the same impact power. At the same time, it can also reduce damage to the drilling tool.

损耗小 LOW LOSS

采用液压双缓冲减震系统, 可有效吸收钻具回传的反冲能, 保持最高的钻进效率, 提高钻具使用寿命, 同时可有效避免长时间的高频振动下对凿岩机、推进梁及钻臂等部件的损伤及相关紧固件的振动松脱情况。Adopting a hydraulic double buffering damping system, it can effectively absorb the recoil energy transmitted by the drilling tool, maintain the highest drilling efficiency, improve the service life of the drilling tool, and effectively avoid damage to components such as the rock drill, propulsion beam, and drilling arm under long-term high-frequency vibration, as well as vibration loosening of related fasteners.

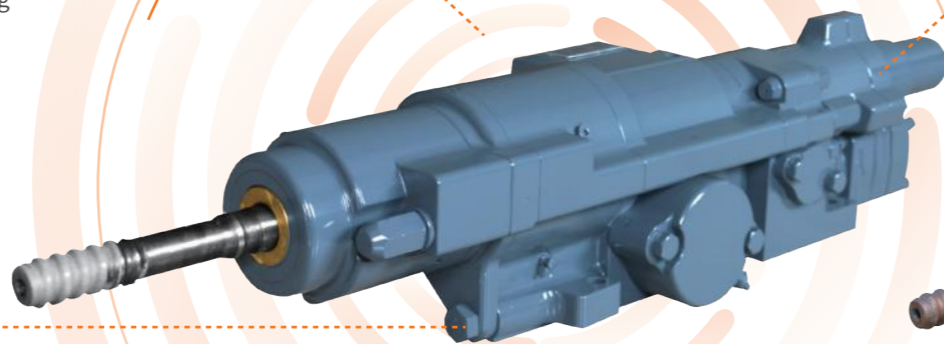
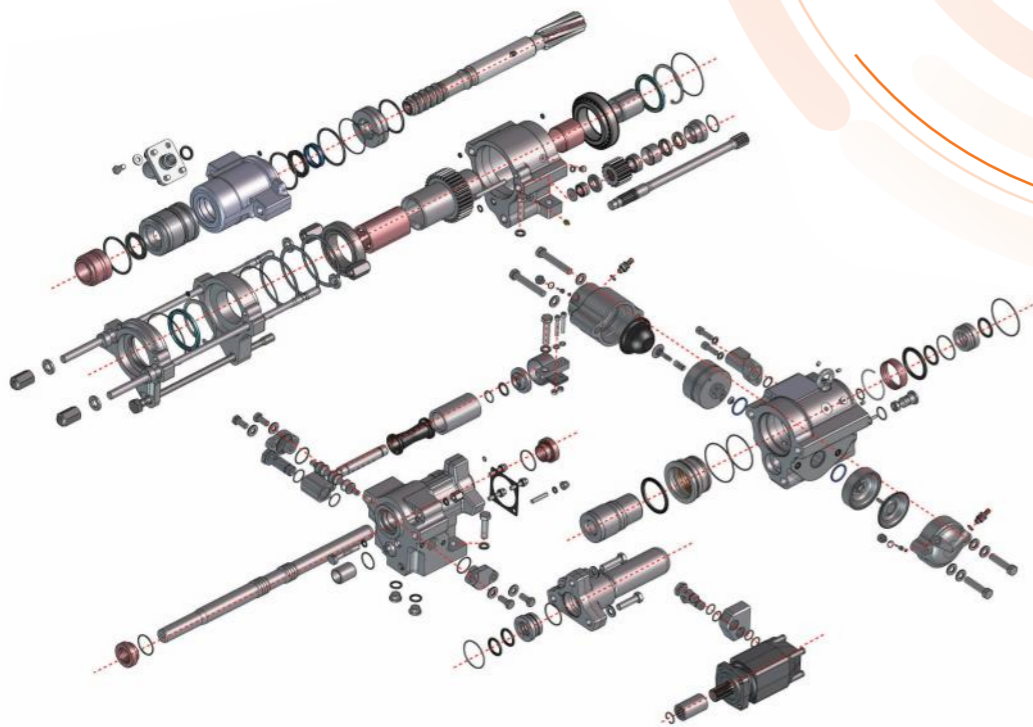

ZY104



ZY103

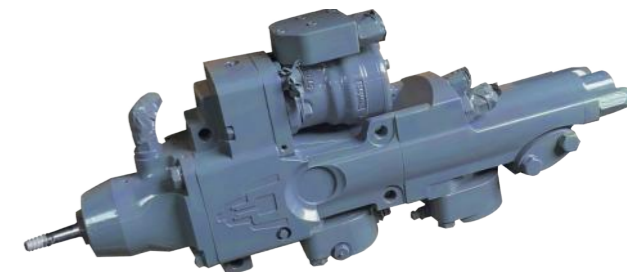

ZY102

寿命长 LONG SERVICE LIFE

接触界面间的压力油膜设计, 可有效防止污染物侵入凿岩机内部传动件之间形成油膜非接触式润滑, 降低磨损损耗, 提高使用寿命。The pressure oil film design between the contact surfaces of the components can effectively prevent contaminants from invading the rock drill, reduce wear and tear, and improve service life.



“大孔径高频高压液压凿岩机技术”

CORE TECHNOLOGY OF DRILLING RIG— HIGH FREQUENCY AND HIGH PRESSURE HYDRAULIC ROCK DRILL

钻机研发核心技术

凿岩机参数 Main Specifications	ZY102X	ZY103	ZY104M	ZY104H
冲击功率最大 Impact power Max. (kW)	11	15	20	20
冲击频率 Impact frequency (Hz)	100	40-60	60	42-50
液压系统压力 Hydraulic pressure(bar)	210	210	230	230
回转系统 Rotation system	独立回转		Independent rotation	
最大扭矩 Rotation torque Max.(N·m)	550	740	740	1500
回转速度 Rotation speed(rpm)	300	0-215	0-215	0-140
机顶至回转中心高 Height over center (mm)	77	88	88	88
耗水量 Water consumption(L/min)	60	35-40	55-120	/
润滑油气量 Lubrication air consumption (在2bar时L/S)	5	5	6	6
润滑油油量 Lubrication oil consumption(mL/min)	3-4	1-1.5	1-1.5	1-1.5
钎尾 Shank adaptor	R32	R32/T38/T45	R32/T38/T45	T45/T51
机重 Weight(kg)	80	150	170	195



- 2014年, 志高掘进(上海)国际贸易有限公司, 在上海成立
- 开发完成400、470一体式露天潜孔钻机、J21地下掘进凿岩台车
- 获多项省级新产品奖

- Zhigao Machinery (Shanghai) International Trading Co., Ltd. was established in Shanghai in 2014.
- Self-developed 400/470 integrated surface drill rig, J21 underground drill rig.
- Won a number of provincial new product awards.

高效的螺杆转子型线 High-efficiency screw rotor profile

- 志高螺杆主机转子采用公司自主研发的转子型线, 相对传统型线, 其具有更合理的泄漏三角形、更短的接触线、更小的排气封闭容积, 转子加工性能优越, 使得压缩机具有卓越的容积效率及绝热效率。
- The self-developed rotor profile has a more reasonable leakage triangle, shorter contact line, smaller discharge sealing volume, and with better CNC machining characteristics, excellent volumetric efficiency and thermal insulation efficiency.

最优的加工制造设备 State-of-the-art machining machines

- 转子加工采用德国进口KAPP磨床, 加工精度可达 $\pm 0.001\text{mm}$ 。
- The rotor machining adopts German KAPP grinding machine $\pm 0.001\text{mm}$.
- 壳体加工采用日本进口加工中心, 加工精度可达 $\pm 0.005\text{mm}$ 。
- Housing machining adopts machining center imported from Japan, the accuracy can reach $\pm 0.005\text{mm}$.
- 英国进口霍洛伊德转子磨型线, 加工精度可达 $\pm 0.002\text{mm}$ 。
- British Holroyd grinding machine, and the accuracy can reach $\pm 0.002\text{mm}$.
- 转子和壳体检测采用德国进口徕斯三坐标测量仪。
- The rotor and housing inspection adopts Leitz coordinate measuring instrument imported from Germany.

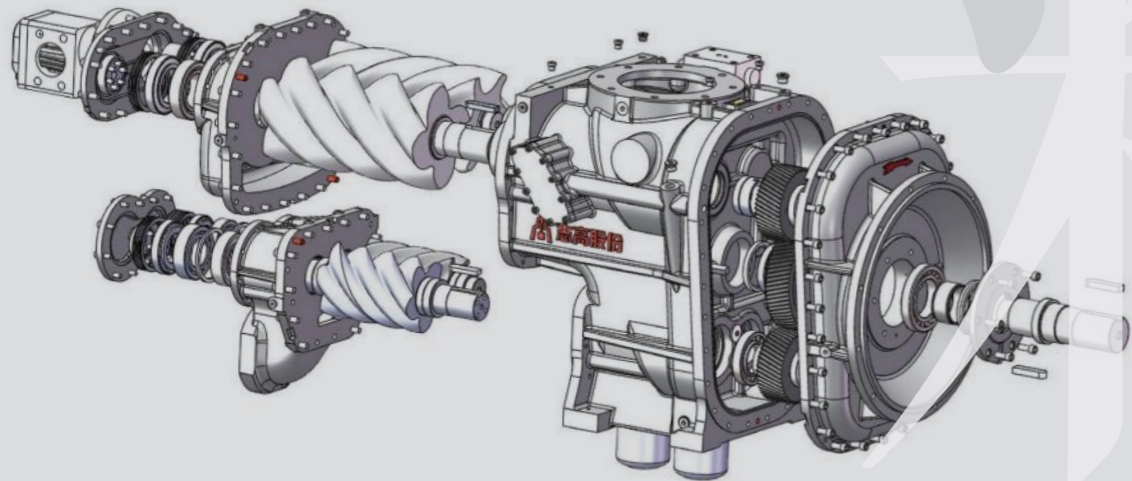

“螺杆主机”100% 自主研发+生产

Research and production of screw Air end

志高螺杆主机功能覆盖图 Screw air end capacity coverage

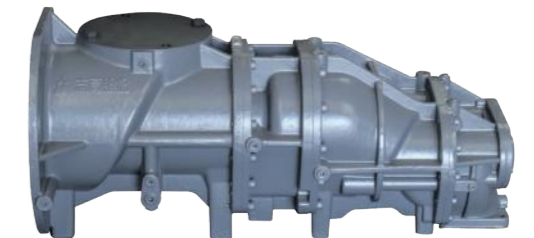
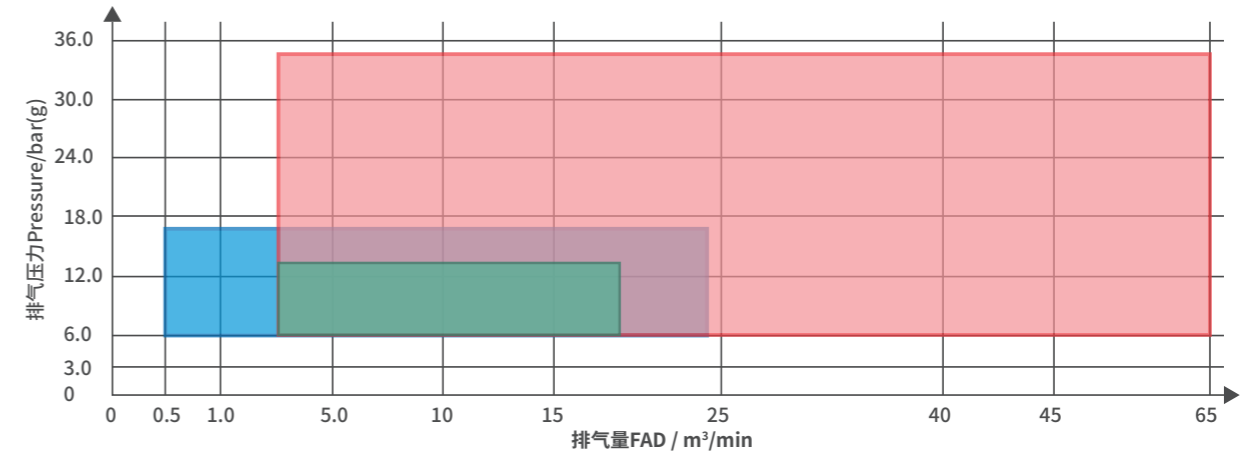

水平双级 Horizontal two-stage



单级压缩 Single Stage

二级压缩 Two Stage





- 2015年, 建成第一工业园区, 新增83亩厂区, 并全面投入建设
- 开发完成ZEGA系列露天钻机及空压机, 并隆重上市
- 履带式露天潜孔钻获评“浙江制造标准”、省级企业研究院
- Y2015, the first industrial park with additional workshop of 13.67 acres, was put into construction.
- Self-developed ZEGA surface drill rigs and air compressors.
- Surface crawler rig was awarded as Manufacturer's Standards in Zhejiang Province, Zhigao was awarded as Enterprise Institute in Zhejiang Province.

工业螺杆式空气压缩机—— Industrial screw air compressor

- 螺杆空压机在现代企业生产过程中起到不可替代的作用, 是常见的**空气动力源**。另外, 通过空气压缩还可实现**仪表控制**、**吹扫**、**输送**等多样化功能。
- 其应用范围覆盖**食品饮料**、**制药行业**、**卷烟行业**、**电力行业**、**重工行业**、**化纤行业**、**制造行业**、**汽车工业**等各大重要行业。
- As a common air power source, screw air compressors play an irreplaceable role in the productive processes of modern enterprises. In addition, through air compression, various functions such as instrument control, purging, and transport can be achieved.
- It can be applied in many crucial fields, such as food and beverage, pharmaceutical, tobacco industry, power, heavy industry, chemical fiber, manufacturing, and automotive.



A 动力源
Power source

B 仪表控制
Instrument control

C 吹扫/输送
Purge & Transport

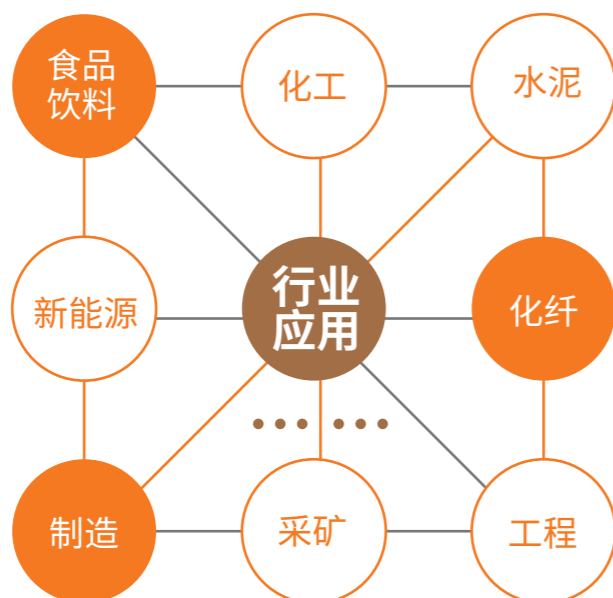

我们依靠先进的技术和设备, 生产全系列一级能效节能螺杆空压机, 满足市场各种生产用气需求。

We rely on advanced technology and equipment to produce a full range of first class energy-efficient and energy-saving screw air compressors, meeting various compressed air needs in the market

同时, 因各工序对压缩空气有不同要求, 客户在气量、气压、空气品质等方面优化选择, 我们乐意向您推荐**志高压缩空气物联网管理系统**, 该系统经多年应用经验优化, 可使螺杆空气压缩机在更合理、更节能、更便捷的环境下使用。

Due to different requirements for compressed air in each process, customers have optimized their choices in terms of air volume, pressure, and air quality. We are willing to recommend the Zhigao Compressed Air IoT Management System to you. After years of application experience, this system has been optimized to enable screw air compressors to be used in a more reasonable, energy-saving, and convenient environment.



- 2016年,浙江志高机械股份有限公司正式在全国中小企业股份转让系统(简称“新三板”)成功挂牌上市
- 开发完成地下UJ18窄体掘进凿岩台车
- 多个省级新产品、衢州市科技进步奖
- Zhejiang Zhigao Machinery Co., Ltd. was officially listed on the National Equities Transfer System for Small and Medium Enterprises (referred to as the "New Third Board") in 2016.
- Self-developed UJ18 underground narrow-veins drill rig.
- Won a number of provincial new product awards, award for Scientific and Technological Advancement in Quzhou.

工程螺杆式空气压缩机—— Engineering Screw Air compressor

■ 工程螺杆空压机主要应用于工程建设、矿业开采、地下能源的**配套空气动力源**,为各类风动工程设备提供动力气源。其应用范围覆盖**喷浆、凿岩、锚杆、水井、石油勘探**等行业。

■ Engineering screw air compressors are mainly applied in construction projects and mining, providing air power source for underground energy and pneumatic engineering equipment. The application scope covers various industries, such as gunite, drilling, anchoring, water well and oil exploration.

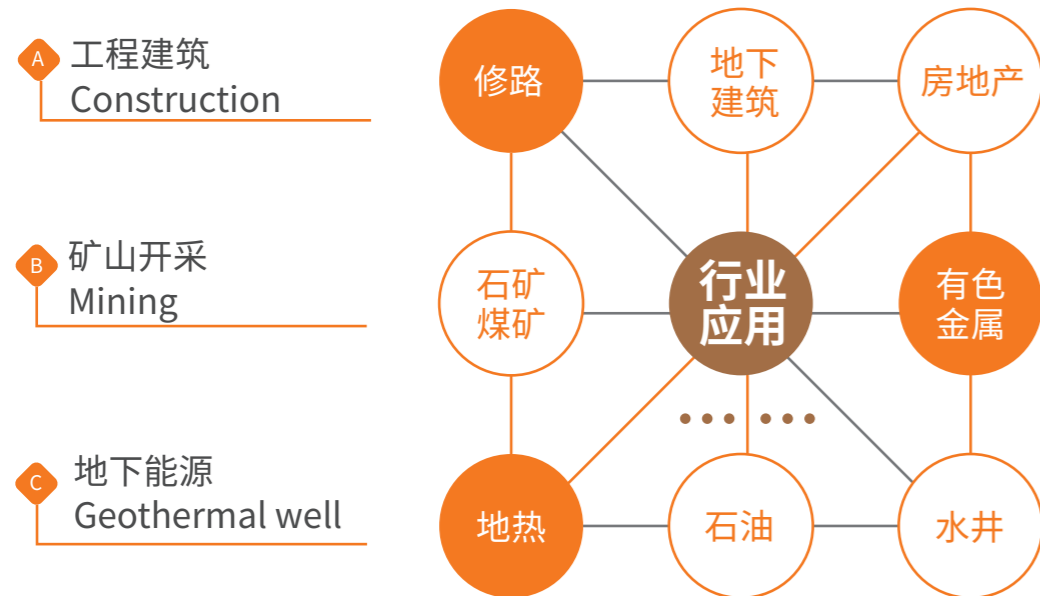

我们致力于开发各类工程所需的全系列柴油、电力驱动空气压缩机, 在高压、大排量机组方面做到行业领先。

We are committed to developing a full range of diesel and electric drive air compressors, and are industry-leading in high-pressure, large-displacement units.

同时,为满足全球用户多样化选择的需求,我们可提供国二/国三/国四/欧五等不同排放等级的不同品牌柴油发动机,以及不同电压/频率的电动机配置。

In addition, in order to meet the diverse needs of global users, we can provide diesel engine drives of different brands with different emission levels, such as China II/China III/China IV/Euro V, as well as electric motor drives with different voltages and frequencies.



- 2017年, 采购先进渗碳/淬火/退火炉和光谱仪等检测设备, 成立热处理车间
- 成功研发了地下三臂凿岩台车UJ33
- 通过“浙江制造”产品认证、中国工程机械制造商30强、轮胎式液压掘进凿岩台车获评“国家行业标准制定”、地下三臂凿岩台车获首台套产品
- Y2017, purchased advanced testing equipment, such as carburizing, quenching and annealing furnaces and spectrometers, and established a thermal treatment workshop.
- Self-developed UJ33 three-booms underground jumbos.
- Zhigao passed the product certification of “Made in Zhejiang”, ranked the top 30 among Chinese construction machinery manufacturers, hydraulic drill rig was awarded as the Formulation of National Industry Standards, three-booms underground jumbo was awarded as the first unit(set) product.

工程露天钻机—— Engineering surface drilling rig

■ 作为中国钻机制造行业的领军企业, 志高机械从2003年8月成立以来, 一直致力于绿色矿山建设、建筑工程、新能源项目, 为保护人类自然环境, 提高资源开发和利用效率, 实现行业绿色长期可持续发展做积极贡献。

■ As a leading enterprise in China's drilling rig manufacturing industry, Zhigao Machinery has been committed to the construction of green mining projects, construction projects, and new energy projects since its establishment in August 2003. It has actively invested in research and development to protect the natural environment, improve resource development and utilization efficiency, and achieve green and long-term sustainable development in the industry.



工程建筑 Construction

- | | |
|---------------|---------------|
| 公路
Highway | 铁路
Railway |
| 机场
Airport | 码头
Wharf |
| | |



绿色矿山 Green mine

- | | |
|-----------------|-----------------|
| 水泥
Cement | 煤矿
Coal mine |
| 采石
Quarrying | 铁矿
Iron mine |
| | |



非爆破行业 Non-blasthole drilling

- | | |
|--------------------|-------------------------|
| 光伏
Photovoltaic | 水井地热
Well geothermal |
| 房地产
Real estate | 边坡治理
Slope treatment |
| | |





- 2018年,新增大型立/卧式龙门加工中心、千吨折弯机、激光切割机和升级公司设计/管理软件。
- 成功研发UJ22地下两臂凿岩台车
- J21轮式单臂掘进钻机获评“浙江制造精品”、市级龙头企业
- Y2018,additional vertical/horizontal gantry machining center,1000 tons bending machine, laser cutting machine and upgraded design/management software used by the corporate.
- Self-developed UJ22 two-booms underground jumbos.
- J21 underground drilling jumbo was awarded as “Quality Goods Made in Zhejiang”; Zhigao was awarded as one of the leading enterprises in Quzhou.

工程地下台车—— Underground drill rig for construction

- 志高机械是国内唯一自主生产**高频高压大功率液压凿岩机**,并自行成功应用和配套的厂家。
- 其各类地下产品经不同工况严格考验,积极为**地下空间利用和矿产资源开采**,以及机械化施工行业提供更优解决方案。
- Zhigao Machinery, the only domestic manufacturer, independently developed high-frequency, high-pressure and high-power hydraulic rock drills and successfully applied it to drilling rigs in economic scale.
- Its various underground equipment has been strictly tested under different working conditions, and actively provides better solutions for the utilization of underground space and mineral resources mining, as well as mechanized construction industry.



地下采矿工程 Underground mining

地下采石 Underground quarrying	巷道掘进 Tunnel excavation
煤矿行业 Coal mining industry	金属矿山 Metal mine



地下建筑工程 Underground construction

洞库建设 Cave construction	地下厂房 Underground powerhouse
隧道掘进 Tunnel excavation	运输管道 Transportation pipeline



地下锚杆工程 Underground rock reinforcement

为岩石发育不稳定和非硬岩地下空间加固提供专用的安全保障设备

Special safety equipment for the reinforcement of unstable and non hard rock underground spaces in rock development





- 2019年, 购入120亩工业用地, 筹建工业螺杆空压机新厂区
- 成功研发了地下UJ21M钻锚注一体凿岩台车
- 省级制造业和互联网融合发展试点和浙江省商标品牌示范企业
- Y2019, purchased a industrial land of 19.7 acres, prepared to build a new workshop for screw air compressors.
- Self-developed UJ21M underground drilling-bolting-grouting drill rig.
- Awarded as the provincial pilot enterprise for the integration of manufacturing and internet, the model enterprise of Zhejiang trademark brand.

2003-2023 PANORAMA OF OVERSEAS SALES OF EQUIPMENT

设备海外销售全景

亚洲 · ASIA

- | | |
|---------------------------|--------------------|
| 孟加拉 Bengal | 马来西亚 Malaysia |
| 格鲁吉亚 Georgia | 老挝 Laos |
| 台湾 (中国) Taiwan (China) | 印度尼西亚 Indonesia |
| 香港 (中国) Hong Kong (China) | 文莱 Brunei |
| 沙特阿拉伯 Saudi Arabia | 新加坡 Singapore |
| 阿富汗 Afghanistan | 朝鲜 North Korea |
| 伊朗 Iran | 斯里兰卡 Sri Lanka |
| 科威特 Kuwait | 尼泊尔 Nepal |
| 土耳其 Türkiye | 巴基斯坦 Pakistan |
| 越南 Vietnam | 印度 India |
| 缅甸 Myanmar | 哈萨克斯坦 Kazakhstan |
| 菲律宾 Philippines | 乌兹别克斯坦 Uzbekistan |
| 柬埔寨 Cambodia | 塔吉克斯坦 Tajikistan |
| 泰国 Thailand | 外蒙古 Outer Mongolia |
| | 韩国 Korea |

非洲 · AFRICA

- | | |
|----------------|------------------|
| 坦桑尼亚 Tanzania | 莫桑比克 Mozambique |
| 埃塞俄比亚 Ethiopia | 刚果 Congo |
| 厄立特里亚 Eritrea | 刚果金 COD |
| 肯尼亚 Kenya | 毛里塔尼亚 Mauritania |
| 乌干达 Uganda | 利比里亚 Liberia |
| 突尼斯 Tunisia | 喀麦隆 Cameroon |
| 埃及 Egypt | 科特迪瓦 Ivory Coast |
| 阿尔及利亚 Algeria | 肯尼亚 Kenya |
| 津巴布韦 Zimbabwe | 加纳 Ghana |
| 安哥拉 Angola | 加蓬 Gabon |
| 赞比亚 Zambia | 马里 Mali |
| 纳米比亚 Namibia | 尼日尔 Niger |
| 几内亚 Guinea | 尼日利亚 Nigeria |
| | 苏丹 Sudan |



欧洲 · EUROPE

- | | | |
|---------------|-------------|------------|
| 意大利 Italy | 波兰 Poland | 瑞典 Sweden |
| 保加利亚 Bulgaria | 塞尔维亚 Serbia | 俄罗斯 Russia |
| 西班牙 Spain | 英国 Britain | 希腊 Greece |

大洋洲 · OCEANIA

- | | |
|----------------|--------------------------|
| 汤加 Tonga | 巴布亚新几内亚 Papua New Guinea |
| 澳大利亚 Australia | 斐济 Fiji |

北美洲 · NORTH AMERICA

- | | |
|----------------|------------|
| 危地马拉 Guatemala | 古巴 Cuba |
| 墨西哥 Mexico | 加拿大 Canada |
| 洪都拉斯 Honduras | |

南美洲 · SOUTH AMERICA

- | | | |
|---------------|-------------|---------------|
| 哥伦比亚 Colombia | 秘鲁 Peru | 智利 Chile |
| 厄瓜多尔 Ecuador | 乌拉圭 Uruguay | 巴西 Brazil |
| | | 阿根廷 Argentina |



We have extensive overseas sales experience and our product application covers 5 continents (79 countries)!
产品应用覆盖 5大洲 / 79国, 拥有丰富的海外销售经验!

经销商合作
Distribution

销售合作
Sales Area

待开发区域
To be developed



- 2020年, 投资2亿元, 成立浙江志高动力科技有限公司, 新建5.8万m²厂房及办公楼
- 研制开发了单级螺杆机主机和志高动力系列品牌工业螺杆压缩机
- 参与制订空压机浙江制造标准, UP45/D480分别获得省首台(套)奖
- ZEGA TECH was established in 2020 with an investment of RMB 200 million. New workshop of 58000m² and office buildings.
- Self-developed single-stage air compressor and ZEGA Brand screw air ends.
- Participated in the Zhejiang manufacturing standards for air compressors, UP45/D480 were awarded as the first set of such machine in China.

借助丰富的案例经验
我们不断提升产品和服务质量
为客户带来更专业的体验



WITH ABUNDANT CASE EXPERIENCE,

WE ENDEAVOR TO CONTINUOUSLY ENHANCE THE QUALITY OF OUR PRODUCTS
AND SERVICES TO PROVIDE CUSTOMERS WITH MORE PROFESSIONAL EXPERIENCES.





- 2021年, 志高动力第二工业园全面建成, 总占地面积8万m²
- 研制开发了全系列单级/双级螺杆主机和ZEGA品牌工业螺杆压缩机
- 行业“隐形冠军”企业、浙江省绿色工厂、浙江省“领雁”研发攻关计划项目
- Y2021,ZEGA second industrial park was completed with a floor area of 80000m².
- Self-developed a full range of single-stage and two-stage screw air ends, as well as ZEGA industry screw air compressor
- Industry "hidden champion" enterprise, Zhejiang green factory, Zhejiang "leading goose" R & D research plan project.

WE NOT ONLY MAINTAIN LONG-TERM AND STABLE COOPERATIVE RELATIONSHIPS
WITH DOMESTIC CUSTOMERS,
BUT ALSO ACTIVELY STRIVE FOR A HIGHER PRESENCE OF OVERSEAS MARKETS!



From 始于 2003

APPLICATION CASES
应用案例

我们不仅与国内客户保持长期稳定的合作关系!
也在积极拓展更广阔的海外市场!



- 2022年,为扩大结构件生产规模,购入邻近工业用地50亩,筹建铆焊分厂
- 开发干式无油螺杆压缩机、UP31地下采矿台车
- 工信部专精特新小巨人
- Y2022,In order to expand the scale of fabrication production, we purchased 8.23 acres of adjacent industrial land and prepared to build a fabrication branch.
- Development of dry oil-free screw air compressor and UP31 underground mining drilling rig.
- Ministry of Industry and Information Technology specializes in special new little giant.



中材·甘肃项目



南方水泥·湖州



中铁·川藏铁路



俄罗斯·煤矿



西十高铁·隧道



华润水泥·云南



老挝·煤矿



韩国·采石场



能建·大石峡



能建·新疆煤矿



济南钢铁·石场



沙特阿拉伯·建设



沙特阿拉伯·石场



华新水泥·湖南



俄罗斯·煤矿



邑金矿业·钨矿



四川·锂矿



青岛·跨海隧道



- 2023年, 志高柳焊第三工业园全面落成
- 研发21K地下锚杆台车、D490大孔径露天潜孔钻机
- 中国商业联合会科学技术奖三等奖
- Y2023, Fabrication 3rd-Industrial Park was fully completed.
- Research and development of 21K underground bolt drilling rig, D490 large-hole surface DTH drilling rig.
- Won the "Science and Technology Award Third Grade Award" issued by the China Chamber of Commerce.

助力企业产业升级, 提升产能 成就空气动力系统解决供应典范!

Assist enterprises in industrial upgrading and increase production capacity
Achieve exemplary solutions for air compression systems!



System Solution Cases

系统解决案例



坐标 Location: 鞍山 Anshan city
主营业务 Main business: 耐火材料 · 2017年 Refractories (2017)

- 志高定制高效节能机型8台(含备用机), 总功率800kW, 替代原有的4台250kW, 1台160kW, 1台55kW, 1台37kW空压机, 最终改造后达到的效果: 实测节能约50%以上。
- Zhigao customized 8 high-efficiency energy-saving models (including backup machines), with a total power of 800kW, replacing the original 4 sets of 250kW, 1 set of 160kW, 1 set of 55kW, 1 set of 37kW air compressors, and the final effect achieved after the transformation: measured energy saving of about 50% or more.



坐标 Location: 河南 Henan
主营业务 Main business: 改造空压机站房 · 2019-2021年 Renovation of air compressor station (2019-2021)

- 采用10台志高定制双级压缩永磁变频机型替代原有空压机, 总功率1200kW;
- 平均节能率在30%-35%, 一年节省电量约400万度;
- 整个站房加装物联网智能管理系统, 实现空压站的数字化、网络化、智能化管理。
- 10 sets of Zhigao customized two-stage compression permanent magnet frequency conversion air compressors are used to replace the original air compressors, with a total power of 1200kW;
- The average energy saving rate is 30%-35%, saving about 4 million kWh of electricity a year;
- The entire air compressor station is equipped with IoT intelligent management system, which realizes digital, networked and intelligent management;

坐标 Location: 南宁 Nanning
主营业务 Main business: 多氟多项目 · 2022年 Polyfluoride project (2022)

- 采用5台志高定制160kW双级压缩高效节能机型+5台智能物联网无液态水冷干机;
- 相同产能, 同等耗气量的情况下, 实测省电约40%, 提升了压缩空气的净化品质;
- 实现了整个空压站房的智能化管理, 降低了设备人工管理成本。
- 5 sets of Zhigao customized 160kW two-stage compression high-efficiency energy-saving air compressor + 5 sets of intelligent IoT non-liquid water freeze dryer;
- Under the condition of the same production capacity and the same air consumption, the measured power saving is about 40%, which improves the purification quality of compressed air;
- It achieves the intelligent management of the entire air compressor station and reduces the labor cost of equipment management;



我们为客户持续供应可靠的零配件 同时也致力于为用户提供一流的售后服务

We continue to provide customers with reliable spare parts, we also committed to providing first-class after-sales service.

- 我们的售后服务团队和代理商保持长期稳定的紧密合作, 打造志高掘进全球服务支持体系, 保障客户在产能持续增长的同时, 降低维修及保养成本。
- Our after-sales service team and agents maintain long-term and stable close cooperation, creating a global service support system for Zhigao Tunnelling, ensuring that customers can continuously increase production capacity while reducing repair and maintenance costs.

正品零件 GENUINE PARTS

- 志高公司客户应使用正宗厂家配件和各种油品以确保机器寿命和使用性能, 并保证机器长期平稳运转;
- Customers should always use authentic or factory approved parts and oils to ensure the life and performance, and the long lasting smooth running of the machine;



钻车服务工作站 SERVICE STATION

- 我们可为用户提供钻车服务工作站, 该服务站运输便捷、配套完善, 让用户享受“矿山及工程设备维护维修、应急配件储备”等一站式服务。
- We can provide users with drilling truck service workstations, which are convenient in transportation and complete in supporting facilities, allowing users to enjoy one-stop services such as "maintenance and repair of mining and engineering equipment, emergency parts reserve".



服务 SERVICE

“不仅在深度, 更在维度!”

Not only in depth, but also in dimensions

服务协议 SERVICE AGREEMENT

志高掘进有不同的协议供客户选择:

- a) 年度服务协议(ASC)
志高的服务人员将按照服务计划, 定期拜访用户, 作检测和服务。
- b) 全程服务和保养协议(FMC)
志高的服务人员将按照固定的保养服务小时, 及时拜访用户, 作检测和服务。
- c) 现场服务合同(SSC)
志高的专业服务工程师将在现场长期跟踪服务, 客户还可以按照实际需求挑选服务方案和时间周期。

Different service plans for customers to choose from:

- a) Annual Service Agreement (ASC)
Zhigao service engineers will visit the users regularly for routine check and service according to the service plan.
- b) Full Service and Maintenance Agreement (FMC)
Zhigao service engineers will visit the users regularly for inspection and service according to the maintenance service hours.
- c) Site Service Contract (SSC)
Zhigao professional service engineers will provide service on site for a long period of time, and customers can also select service plans and time periods according to actual needs.

质保服务 QUALITY ASSURANCE SERVICES

我们提供符合国际行业标准的质保服务;

同时, 我们正谋求开展高于行业标准的“质保期延长”计划: 树立行业标杆, 提升品牌实力!

We provide quality assurance services that meet international industry standards;

At the same time, we are seeking to carry out a "warranty period extension" plan that exceeds industry standards: establish industry benchmarks, and enhance brand strength!

品牌授权 licensing

我们给予具备客户服务能力, 且满足考核条件的代理商正式授权, 并颁发授权证书。
We grant corresponding authorization to eligible agents and issue corresponding authorization letters and certificates.

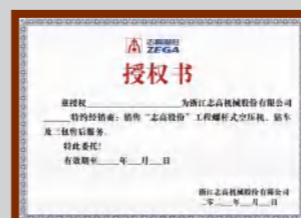

Accessories & Services

配件与服务

Continuously improving After-sales service network system

不断完善的售后服务网络体系



完善的服务网络, 为客户在常规的售后问题处理上
提供更加准确高效的解决方案。

Well organized service network guarantees daily after-sales claims
to be handled effectively at a professional manner.



承诺服务事项 SERVICE PROMISES

我们在全球拥有数百个服务网点, 国内各省份站点配备率达100%, 为用户提供尽可能

我们承诺: 国内站点覆盖区域提供7天/24小时全天候服务; 站点未覆盖区域提供24小时时限到达服务。

售后服务邮箱: aftermarket@zhigaojx.com

We have hundreds service outlets, with a station allocation rate of 85% in various provinces in China, Provide users with

We promise to provide 24/7 service within the coverage area of domestic sites; The area not covered by the site provides

After sales service email: aftermarket@zhigaojx.com

及时的售后及配件支持!

timely after-sales support as much as possible!

a 24-hour arrival service.

CONTINUOUSLY OPTIMIZED SERVICE SITE DESIGN

不断优化的服务站点设计



PROFESSIONAL SERVICE TEAM INTERNAL & EXTERNAL

专业的内勤+外勤服务团队



回首初心

REVIEW THE ORIGINAL INTENTION

企业荣誉 Corporate Honors

- 中国商业联合会科学技术奖三等奖 ----- 2023年
- 工信部专精特新小巨人 ----- 2022年
- 行业“隐形冠军”企业 ----- 2021年
- 浙江省绿色工厂 ----- 2021年
- 浙江省“领雁”研发攻关计划项目 ----- 2021年
- 参与制订空压机浙江制造标准 ----- 2020年
- UP45/D480分别获得省首台(套) ----- 2020年
- 省级制造业和互联网融合发展试点企业 ----- 2019年
- 浙江省商标品牌示范企业 ----- 2019年
- J21轮式单臂掘进钻机获评“浙江制造精品” ----- 2018年
- 市级龙头企业 ----- 2018年
- 通过“浙江制造”产品认证 ----- 2017年
- 中国工程机械制造商30强 ----- 2017年
- 产品获评“国家行业标准制定” ----- 2017年
- 地下三臂钻机获“首台套产品” ----- 2016年
- 多个省级新产品、衢州市科技进步奖 ----- 2016年
- 履带式露天潜孔钻获评“浙江制造标准” ----- 2015年
- 省级企业研究院 ----- 2015年
- 获多项省级新产品奖 ----- 2014年
- 获浙江省著名商标 ----- 2013年
- 浙江省企业技术中心、浙江名牌 ----- 2012年
- 履带式露天钻机国家行业标准起草制定单位 ----- 2011年
- 项目被科技部列入“国家火炬计划” ----- 2010年
- 国家高新技术企业 ----- 2010年
- 产品被经信委评为“装备制造业重点领域首台(套)产品” ----- 2009年
- 浙江省先进制造业基地 ----- 2008年

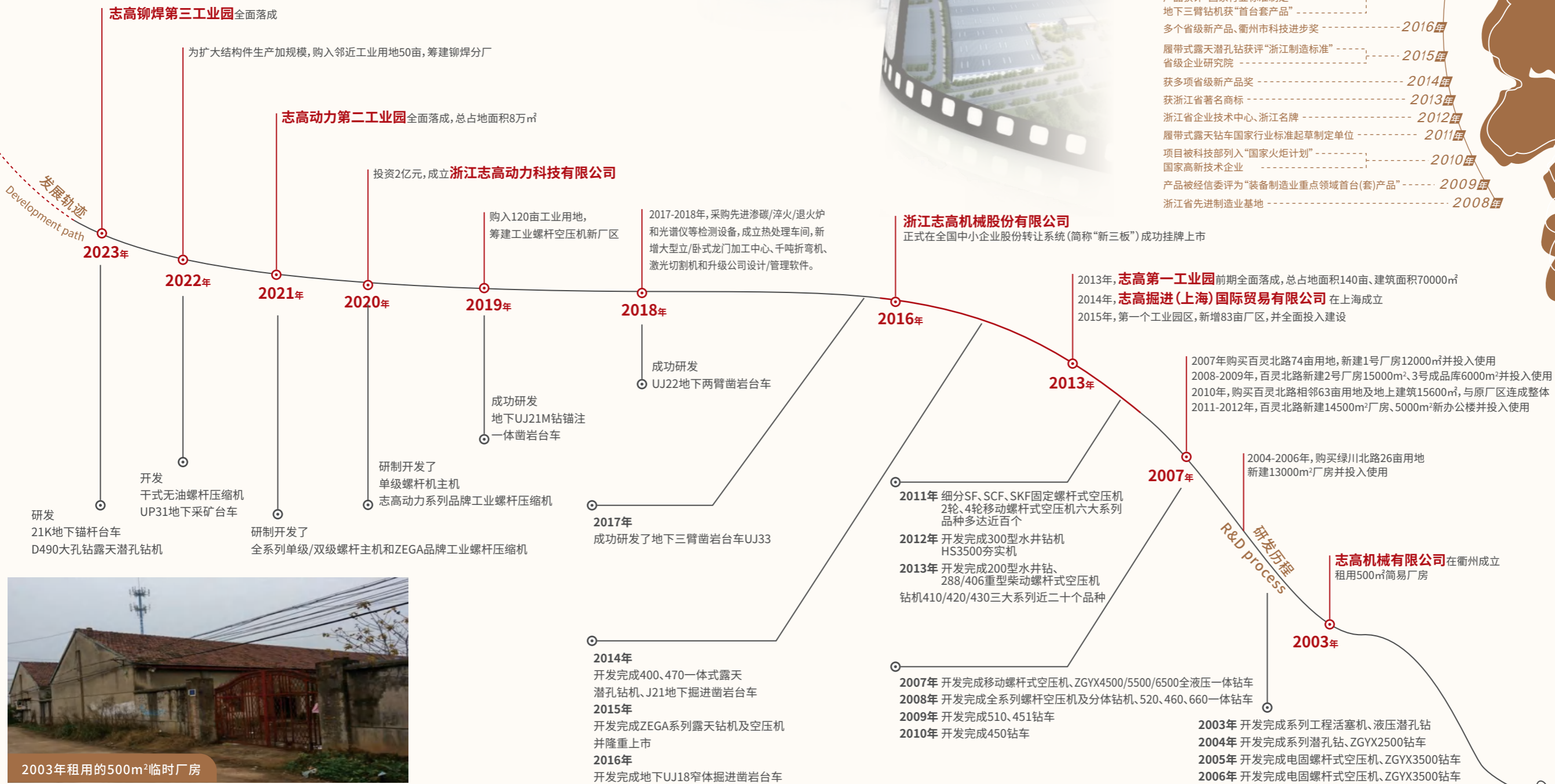

未来十年发展规划

DEVELOPMENT PLAN FOR THE NEXT 10 YEARS

作为衢州市慈善总会副会长单位，我们将持续积极为慈善事业做出更多的贡献。

As the vice president unit of Quzhou Charity Federation, we will continue to actively contribute to the charity cause.



To establish a global network of 500 authorized distributors

Leading supplier in the industrial and construction sector

工业工程领域系统集成供应领先者

完善全球500家授权经销商

Form a supply chain system that conforms to the development

建立符合发展规律的供应链体系

Creation of ZHIGAO Technology and Application Academy (ZTAA)

创建专业技术和产品应用学院

2034年

成为一家国际化企业

Become an international company



2024年

Future

 志高掘进

 ZEGA

 志高动力



Build Dreams and Achieve the Future Together with Zhigao Machinery

与志高股份一起 构筑梦想成就未来

重细节

Emphasizing details



求高效

Seeking efficiency



铸品质

Based on quality

STRIVING

创未来 **FOR**

THE BRIGHTER FUTURE