













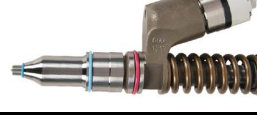
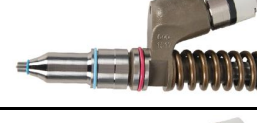
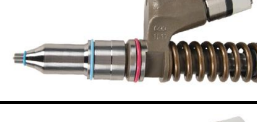
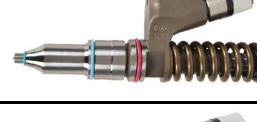
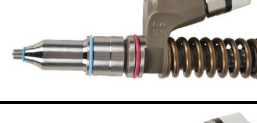
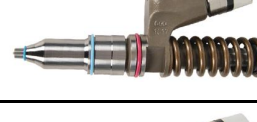





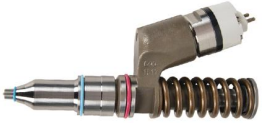









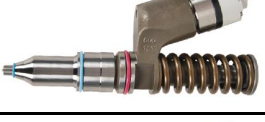
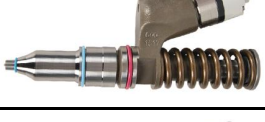
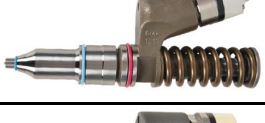

LIAOCHENG COMMONRAIL AUTOPARTS CO., LTD

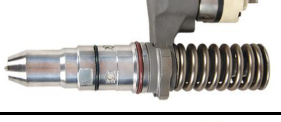
C15 C18 3126 3512 INJECTOR

Number	Part Number	Engine Model	Other	Pictures
1	374-0750	C15		
2	374-0751	C15		
3	253-0614	C15		
4	253-0615	C15		
5	253-0616	C15		
6	253-0617	C15		
7	211-3022	C15		
8	211-3025	C15		
9	200-1117	C15		
10	20R-2284	C15		
11	20R-2285	C15		

12	10R3263	C15		
13	10R-3264	C15		
14	10R-3265	C15		
15	10R-2782	C15		
16	10R0956	C15		
17	10R0955	C15		
18	295-9085	C15		
19	10R-8988	C15		
20	229-5919	C15		
21	10R1073	C15		
22	10R1000	C15		
23	291-5911	C18		
24	211-3028	C18		





25	276-8307	C18		
26	253-0618	C18		
27	10R-7230	C18		
28	10R-7228	C18		
29	10R-7231	C18		
30	10R7228	C18		
31	392-0200			
32	392-0221			
33	177-4754	3126		
34	177-4752	3126		
35	177-0199	3126		
36	10R-0781	3126		
37	10R-0781	3126		

















38	198-6605	3126		
39	222-5966	3512		
40	4P9075	3512		
41	4P9076	3512		
42	4P9077	3512		
43	7E6408	3512		

























LIAOCHENG COMMONRAIL AUTOPARTS CO., LTD

C7 C9 C-9 3116/3114 320D Injector Lists

No.	Injector No.	Matching For Diesel Engine	Matching For engineering truck	Pictures
1	387-9427	C7	324D/325D/326D/329D	
2	238-8901	C7	324D/325D/326D/329D	
3	241-3239	C7	324D/325D/326D/329D	
4	243-4502	C7	324D/325D/326D/329D	
5	263-8218	C7	324D/325D/326D/329D	

6	268-1835	C7	324D/325D/326D/329D	
7	268-9577	C7	324D/325D/326D/329D	
8	269-1839	C7	324D/325D/326D/329D	
9	328-2585	C7	324D/325D/326D/329D	
10	328-2586	C7	324D/325D/326D/329D	
11	387-9426	C7	324D/325D/326D/329D	
12	387-9428	C7	324D/325D/326D/329D	
13	387-9430	C7	324D/325D/326D/329D	
14	10R-7225	C7	324D/325D/326D/329D	
16	387-9433	C9	330D/336D	
17	254-4330	C9	330D/336D	
18	254-4339	C9	330D/336D	
19	254-4340	C9	330D/336D	
20	267-3360	C9	330D/336D	
21	267-9710	C9	330D/336D	
22	267-9717	C9	330D/336D	
23	293-4573	C9	330D/336D	

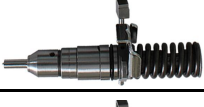
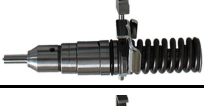
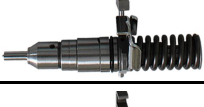
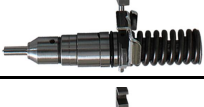
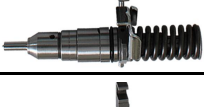
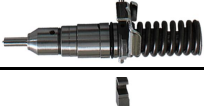
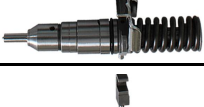
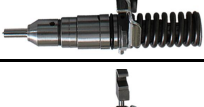
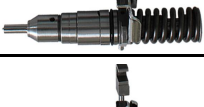
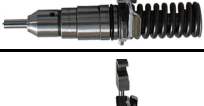
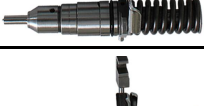
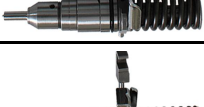
24	293-4574	C9	330D/336D	
25	328-2576	C9	330D/336D	
26	328-2580	C9	330D/336D	
27	387-9432	C9	330D/336D	
28	387-9434	C9	330D/336D	
29	10R-7222	C9	330D/336D	
30	235-2888	C-9	330C	
31	235-9649	C-9	330C	
32	236-0962	C-9	330C	
33	10R-7224	C-9	330C	
34	127-8216	3114/3116/3126		
35	127-8222	3114/3116/3126		
36	127-8205	3114/3116/3126		
37	127-8207	3114/3116/3126		
38	127-8209	3114/3116/3126		
39	127-8211	3114/3116/3126		
40	127-8213	3114/3116/3126		



41	127-8218	3114/3116/3126		
42	127-8225	3114/3116/3126		
43	127-8228	3114/3116/3126		
44	127-8230	3114/3116/3126		
45	1077732	3114/3116/3126		
46	4P2995	3114/3116/3126		
47	7E8729	3114/3116/3126		
48	7E9585	3114/3116/3126		
49	1620218	3114/3116/3126		
50	OR8461	3114/3116/3126		
51	OR8465	3114/3116/3126		
52	OR8467	3114/3116/3126		
53	OR8469	3114/3116/3126		
54	OR8471	3114/3116/3126		
55	OR8473	3114/3116/3126		
56	OR8475	3114/3116/3126		
57	OR8477	3114/3116/3126		

58	OR8483	3114/3116/3126		
59	OR8633	3114/3116/3126		
60	OR8682	3114/3116/3126		
61	OR8684	3114/3116/3126		
62	OR8867	3114/3116/3126		
63	1071230	3114/3116/3126		
64	32F61-00062	C6. 4	320D	
65	326-4700 326-4756		312D/313D/320D/321D/323D/C6. 4	
66	10R7575.			
67	2645A738			
68	320-4740		315D/318D/319D	
69	2645A745			
70	2645A746 320-0677			
71	2645A747 320-0680	C6. 6		
72	2645A749 320-0690			
73	2645A753 321-3600			



LIAOCHENG COMMONRAIL AUTOPARTS CO., LTD

CAT Element Lists

Number	Part Number	Engine Model	Other	Pictures
1	7N1183		4194742	
2	7N1185		4194743	
3	7N1220			
4	8S3656		4194750	
5	7W0182	D333C/3306	3919893	
6	7W5929	3406	3919895	
7	9H5797	D330A/D333	3919891	
8	1P6400	3406	3831568	
9	1W6541	3300B		
10	4P9830			
11	1W3010			

12	4N4997			
13	9H5796			
14	1086631		4194744	
15	1422812			
16	4S5758			
17	9L4102			
18	1082104		4194744	
19	8N3539	Caterpillar 3204		
20	6N7527	Caterpillar D333C/3306	7N5301	



LIAOCHENG COMMONRAIL AUTOPARTS CO., LTD





CAT Pump Element Lists

Number	Part Number	Engine Model	Other	Pictures
1	1W6539			
2	4P9827			
3	7W0561		4328278	
4	7W5928			
5	6N7829			
6	108-6630		4328276	
7	108-6634			
8	108-6633		4328215	



LIAOCHENG COMMONRAIL AUTOPARTS CO., LTD











CAT D/valve Lists













Number	Part Number	Product Name	Other	Pictures
1	1W6987		4206221	
2	4P7688		4206215	
3	1W6982		4206215	
4	4P9258			

















LIAOCHENG COMMONRAIL AUTOPARTS CO., LTD

CAT Nozzle Lists

Number	Part Number	Engine Model	Pictures
1	8N1831	342T	
2	8N4694	3304	
3	8N8796	3304	
4	8N4697	D3333C/3306	
5	8M1584	D3333C/3306	
6	8N5986	D3333C/3306	
7	3S6638	D3333C/3306	
8	9L6884	3400	
9	7C2238	3500	
10	7C0340		
11	8N7005	3300B	

12	7W7038	3300B	
13	4W7015	3204	
14	4W7016	3208	
15	4W7017	3400	
16	4W7018	3400	
17	4W7019	3400	
18	7W7026	3400	
19	7W7032	3400	
20	104-9453	3300B	
21	22808/7N0449	3300	
22	F237/1W5829	3208	
23	22762/9L6969	3200	
24	9N2366	1100/3100	

25	27333/RE89564		
26	27336/RE37503		
27	20494/AR50781		
28	28481/RE36935		
29	28485/RE36939		
30	29279/RE48786		
31	32262/RE60062		
32	26632		
33	26964		
34	33408		
35	20668		
36	28412		
37	32777		











38	20497. B08		
39	20499. B08		
40	38416. K08		

























LIAOCHENG COMMONRAIL AUTOPARTS CO., LTD









Commonrail Injector Lists













No.	Injector No.	Nozzle Marking No.	Valve No.	Matching For Diesel Engine	Pictures
1	0 445 110 141	DLLA146P1296	F 00V C01 022	RENAULT	
2	0445 110 189 0445 110 190 0445 110 181 0445 110 182 0986435055	DSLA154P1320	F 00V C01 051	DC	
3	0 445 110 376 0 445 110 594	DLLA145P2168	F 00V C01 383	CUMMINS ISF2.8	
4	0 445 110 808	DLLA145P2557	F 00Z C01 367	CUMMINS ISF2.8/ISF3.8	
5	0 445 110 515	DLLA143P2364	F 00V C01 359	QINGLING (庆铃)	
6	0 445 110 531	DLLA151P2359	F 00V C01 359	Foton	
7	0 445 110 691	DLLA151P2488	F 00V C01 359	FOTON 4JB1_2.8LC	
8	0 445 110 690	DLLA146P2487	F 00V C01 359	FOTON 4JB1_2.8LC	
9	0 445 110 293 0 445 110 407	DLLA150P1666	F 00V C01 359	Greatwall	











10	0 445 110 719	DLLA148P2497	F 00V C01 359	Greatwall	
11	0 445 110 380 0 445 110 462 0 445 110 481	DLLA150P2156	F 00V C01 359		
12	0 445 110 364 0 445 110 365	DLLA148P2129	F 00V C01 359	CHAHNGCHAI 4B28TC	
13	0 445 110 454	DLLA150P2272	F 00V C01 359	JMC S350 2.8L- 4JB1	
14	0445 110 521 0445 110 305	DLLA82P1668	F 00V C01 359	JMC 4JB1	
15	0 445 110 805 0 445 110 804	DLLA149P2556	F 00V C01 359	JMC	
16	0 445 110 626 0 445 110 627	DLLA150P2434	F 00V C01 359	JMC 4JB1_EU4	
17	0 445 110 465 0 445 110 466 0 445 110 717 0 445 110 718	DLLA140P2281	F 00V C01 359	JAC 2.8 HFCADA1- 2C (HF4DA1-2C)	
18	0 445 110 710	DLLA157P2508	F 00V C01 359	JAC HF4DA ; 12.5L 85KW	
19	0 445 110 335 0 445 110 512	DLLA82P1773	F 00V C01 359	JAC 2.8L(江淮)	
20	0 445 110 343 0 445 110 412	DLLA150P1808	F 00V C01 359	JENS	
21	0445 110 345	DLLA148P1809	F 00V C01 359	YANGCHAI	











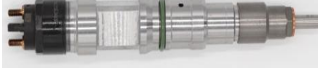

22	0445 110 516 0445 110 752	DLLA148P2361	F 00V C01 359	YANGCHAI	
23	0 445 110 537	DLLA143P2356	F 00V C01 359	JMC	
24	0 445 110 628 0 445 110 629	DLLA150P2440	F 00V C01 359	JMC	
25	0 445 110 538 0 445 110 539	DLLA150P2362	F 00V C01 359	JMC (江铃), QINGLING (庆铃)	
26	0 445 110 632 0 445 110 633	DLLA150P2436	F 00V C01 359	WOLF/ISUZU JE493	
27	0 445 110 694	DLLA150P2482	F 00V C01 359	WOLF /ISUZU	
28	0 445 110 696	DLLA150P2489	F 00V C01 359	FAW FOUR-RINGS	
29	0 445 110 355 0 445 110 509	DLLA150P2121	F 00V C01 359	FAW FOUR-RINGS	
30	0 445 110 623 0 445 B76 583	DLLA145P2431	F 00V C01 359	DONGFENG D28_EU4	
31	0 445 110 541	DLLA153P2351	F 00V C01 359	XICHAI490 4DW/DEUTZ/FAWDE	
32	0 445 110 821	DLLA150P2572	F 00V C01 359	WEICHAI	
33	0 445 110 891	DLLA150P2616	F 00V C01 359	WEICHAI	













34	0 445 110 786 0 445 110 787 0 445 110 791 0 445 110 792	DLLA158P2539	F 00V C01 359	QUANCHAI 4D22EA	
35	0 445 110 798 0 445 110 799	DLLA155P2547	F 00V C01 359	QUANCHAI	
36	0 445 110 861 0 445 110 862	DLLA150P2596	F 00V C01 359	QUANCHAI	
37	0 445 110 796	DLLA153P2546	F 00V C01 359	CHAOCHAI	
38	0 445 110 527 0 445 110 526	DLLA152P2348	F 00V C01 358	YUNNEI YN38CRD	
39	0 445 110 756 0 445 110 757	DLLA148P2523	F 00V C01 359	CHANGCHAI	
40	0 445 110 445 0 445 110 446 0 445 110 313	DLLA147P1702	F 00V C01 359	FOTON 4JB1_2.8L	
41	0 445 110 867	DLLA151P2601	F 00V C01 350	FOTON	
42	0 445 110 630 0 445 110 631	DLLA150P2439	F 00V C01 359	JMC	
43	0 445 110 853 0 445 110 854	DLLA149P2593	F 00V C01 359		
44	0 445 110 332	DLLA150P1772	F 00V C01 359		
45	0 445 110 443	DLLA162P2266	F 00V C01 377	Greatwall	













46	0 445 110 357	DLLA150P2122	F 00V C01 359	FAW CA4D28CR2L	
47	0 445 110 395	DLLA151P2188	F 00V C01 359	FAW 4DW	
48	0 445 110 427	DLLA151P2225	F 00V C01 359	FAW 4DW	
49	0 445 110 885	DLLA149P2611	F 00V C01 359		
50	0 445 110 886	DLLA149P2611	F 00V C01 359		
51	0 445 110 966 0 445 110 965	DLLA152P2656	F 00V C01 359	QUANCHAI	
52	0 445 110 529 0 445 110 528	DLLA152P2350	F 00V C01 358	YUNNEI YN33CRD	
53	0 445 110 669 0 445 110 670	DLLA82P1773	F 00V C01 359	JAC/JENS	
54	0 445 110 748	DLLA153P2521	F 00V C01 359	ISUZU	
55	0 445 110 766	DLLA145P2529	F 00V C01 359	DONGFENG D28 CRS1_16 CN4 85KW	
56	0 445 110 769	DLLA145P2529	F 00V C01 359	DONGFENG	
57	0 445 110 397	DLLA150P2186	F 00V C01 359	DONGFENG CHAOCHAI	

58	0 445 110 346 0 445 110 347	DLLA150P1812	F 00V C01 359	QUANCHAI	
59	0 445 110 392	DLLA155P2179	F 00V C01 359	QUANCHAI	
60	0 445 110 403	DLLA150P1812	F 00V C01 359	QUANCHAI	
61	0 445 110 416 0 445 110 417	DLLA155P2226	F 00V C01 359	QUANCHAI	
62	0 445 110 448	DLLA150P1812	F 00V C01 359	QUANCHAI	
63	0 445 110 449	DLLA150P1812	F 00V C01 359	QUANCHAI	
64	0 445 110 548	DLLA150P1812	F 00V C01 359	QUANCHAI	
65	0 445 110 549	DLLA150P1812	F 00V C01 359	QUANCHAI	
66	0 445 110 824 0 445 110 825	DLLA150P2576	F 00V C01 359	QUANCHAI	
67	0 445 110 826 0 445 110 827	DLLA150P2578	F 00V C01 359	QUANCHAI	
68	0 445 110 734 0 445 110 735	DLLA150P2511	F 00V C01 359	QUANCHAI	
69	0 445 110 780	DLLA148P2538	F 00V C01 359	YANGCHAI	

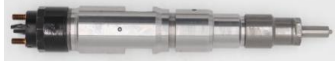
70	0 445 110 782	DLLA153P2542	F 00V C01 359	YANGCHAI	
71	0 445 110 517	DLLA158P2347	F 00V C01 359	YANGCHAI, DEUTZ	
72	0 445 110 533	DLLA148P2356	F 00V C01 359	CHANGCHAI 4B28TC	
73	0 445 110 672	DLLA143P2472	F 00V C01 359	QINGLING NKR55	
74	0 445 110 721	DLLA143P2500	F 00V C01 359	QINGLING	
75	0 445 110 767	DLLA143P2536	F 00V C01 359	QINGLING	
76	0 445 110 693	DLLA153P2484	F 00V C01 359	CHAOCHAI	
77	0 445 110 887	DLLA149P2614	F 00V C01 359		
78	0 445 110 646 0 445 110 647 0 445 110 688 0 445 110 689	DLLA162P2160+	FO0VC01502/ FO0VC01517	VM Amarak 2.0(大众) /Caddy/Golf	 0445 110 646
No.	Injector No.	Nozzle Marking No.	Valve No.	Matching For Diesel Engine	Sample Pictures
1	0 445 120 007	DSLA143P970	F 00R J00 339	CUMMINS	

2	0 445 120 127	DLLA143P1696	F 00R J01 727	WECHAI WP12	
3	0 445 120 045	DSLA154P1418	F 00R J01 159	MAN TRUCK	
4	0 445 120 218 0 445 120 030	DLLA146P1339	F 00R J02 466		
5	0 445 120 217	DLLA148P1524	F 00R J02 466		
6	0 445 120 059	DSLA128P1510	F 00R J02 130	CUMMINS SAA6D107E-1 CUMMINS QSB6.7	
7	0 445 120 231	DSLA128P5510	F 00R J02 130	CUMMINS QSB6.7	
8	0 445 120 236	DLLA118P2203	F 00R J01 941	CUMMINS PC359-7;QSL9	
9	0 445 120 066	DLLA144P1565	F 00R J01 479	DEUTZ D6D	
10	0 445 120 067	DLLA146P1581	F 00R J01 479	DEUTZ	
11	0 445 120 086	DLLA145P1655	F 00R J01 727	WEICHAI	
12	0 445 120 221 0 445 120 129 0 445 120 200 0 445 120 223 0 986 AD1 011	DLLA146P1725	F 00R J01 692	WEICHAI	
13	0 445 120 244	DLLA150P1781	F 00R J01 692	WEICHAI	

14	0 445 120 265	DLLA148P2221	F 00R J01 727	WEICHAI	
15	0 445 120 266	DLLA148P2222	F 00R J01 727	WEICHAI	
16	0 445 120 343	DLLA152P2344	F 00R J01 692	WEICHAI	
17	0 445 120 391	DLLA147P2474	F 00R J01 727	WEICHAI	
18	0 445 120 106 0 445 120 310	DLLA153P1721	F 00R J02 056		
19	0 445 120 123	DSLA140P1723	F 00R J02 130	CUMMINS ISDEe 4Cylinder/6Cylinder	
20	0 445 120 212	DSLA143P5501	F 00R J02 130	CUMMINS ISBe, EEA ,	
21	0 445 120 121	DLLA142P1709	F 00R J01 941	CUMMINS ISLe_EU3	
22	0 445 120 122	DLLA144P1707	F 00R J01 941	DONGFENG CUMMINS ISLEe	
23	0 445 120 134	DLLA141P2146	F 00R J02 103	CUMMINS BFCEC LDA3, 81_AVALON	
24	0 445 120 297	DLLA145P2270	F 00R J02 103	FOTON CUMMINS	
25	0 445 120 489	DLLA120P2613	F 00R J02 806	FOTON CUMMINS	







26	0 445 120 149 0 445 120 169 0 445 120 213 0 445 120 214	DLLA152P1768	F 00R J01 692	WEICHAI WD10	
27	0 445 120 224	DLLA152P1819	F 00R J01 692	WEICHAI WD10/CUMMINS /KAMAZ	
28	0 445 120 153	DLLA147P1814	F 00R J01 692	Kamaz, Russia	
29	0 445 120 215 0 445 120 394	DLLA149P2166	F 00R J02 035	FAWDE	
30	0 445 120 395	DLLA150P2197	F 00R J01 657	FAWDE	
31	0 445 120 277	DLLA151P2240	F 00R J02 035	FAWDEDE CA6DM2_EU4	
32	0 445 120 078 0 445 120 393	DLLA150P1622	F 00R J01 657	FAWDE (6DL1/6DL2)	
33	0 445 120 289	DLLA142P2262	F 00R J02 472	DONGFENG CUMMINS	
34	0 445 120 367	DLLA127P2402	F 00R J02 472	DONGFENG CUMMINS	
35	0 445 120 294	DLLA150P2282	F 00R J01 657	YUCHAI	
36	0 445 120 321	DLLA148P2369	F 00R J02 103		
37	0 445 120 357	DLLA150P2386	F 00R J01 692		

38	0 445 120 368	DLLA154P2406	F 00R J02 561		
39	0 445 120 415	DLLA148P2516	F 00R J02 103		
40	0 445 120 361	DLLA145P2397	F 00R J02 103	Saic Fiat Powertrain Hongyan	
41	0 445 120 178	DLLA150P2153	F 00R J02 429	JAMZ	
42	0 445 120 186	DLLA153P1831	F 00R J02 449	MAN TRUCK	
43	0 445 120 126	DLLA135P1747	F 00R J02 266	MHIMHI, YN33CRD	



LIAOCHENG COMMONRAIL AUTOPARTS CO., LTD

Commonrail Injector Lists

NO.	Injector No.	Nozzle Marking No.	Pictures
1	23670-0L020 23670-30370 23670-0L050 095000-829# 095000-8220 095000-856# 095000-592#	DLLA155P1062	
2	23670-30050 095000-5880 095000-5881 095000-5660	DLLA145P864	
3	23670-30300 095000-7760 095000-7761 095000-7751 095000-7750 23670-39276	DLLA145P1024	
4	23670-0L010 23670-0L070 23670-30240 23670-09360 095000-874# 23670-09360 095000-8530	DLLA145P1024 (093400-1024)	
5	23670-0L090 294050-0521 2950500520	G3S6	
6	23670-30400 295050-0460 095000-0800	G3S6	

7	095000-778X 23670-30280 23670-39185 23670-39215 23670-39315 23670-39310 23670-30140 23670-30220 23670-09070	DLA155P1025	
8	23670-0L110 23670-09380 295050-054# SM295050-0810	G3S33	
9	095000-5550 095000-8310	DLA150P866 DLA150P1059	
10	095000-5600 1465A041	DLA145P870 (093400-8700)	
11	095000-6363 095000-6364 095000-6366 (8-97609788-3)	DLA158P844 DLA158P1092 DLA145P970	
12	095000-956x 1465A257	DLA155P1030	
13	095000-5471 095000-5470 095000-5473 095000-5474 095000-8900 095000-8901 095000-8902 095000-6373 095000-8903 095000-0660 (8-98284393-	DLA158P984 DLA158P1096	
14	095000-6353 095000-6350 095000-6352	DLA155P848	

15	095000-6593 095000-6951 095000-6952 095000-6594	DLLA155P842	
16	095000-6491 095000-6490 095000-6492 RE529118	DLLA139P887	
17	095000-6310 095000-6311 RE530362	DLLA127P944	
18	095000-534x 8-97602485-6	DLLA158P1092/P844	
19	095000-6480 RE529149	DLLA125P889	
20	095000-1211 095000-1210	DLLA142P852	
21	095000-6070	DLLA148P915	
22	9709500-751x	DLLA150P1032	
23	095000-9690	DLLA150P1113	
24	095000-5800 095000-5801	DLLA153P884	
25	095000-7060 6C1Q-9K546-BC	DLLA153P885	
26	095000-8940 RE543266	DLLA127P1098	





27	095000-5050 RE507860	DLLA133P814	
28	095000-5230	DLLA148P828	
29	095000-1560 8-98259287-0	G3S99	
30	095000-1550 8-98259287-0	G3S93	
31	095000-8060 095000-9770 23670-51040		
32	095000-7711 095000-7710 095000-9780 23670-51030		
33	23670-0E010(G4)*4 295700-0550		
34	23670-0E020(G4) 295040-9440 295700-0560	2015-2018	
35	095000-811# 095000-576# 1465A054 1465A307	DLLA145P875	 095000-5760
36	095000-5511 8-97603415-8 095000-5512 095000-5517 8-97603415-8 095000-5513	DLLA152P865 DLLA152P1097 DLLA152P929	



LIAOCHENG COMMONRAIL AUTOPARTS CO., LTD

General Injector Lists

Number	Part Number	Other	NOZZLE	Pictures
1	193-2749 (005Z18-3330AZ)	3436103030	DLLA155PN276	
2	212-8470 (208Z48-4480A)	3436106070	DLLA150PN315	
3	517706 (392Z48-3330N)	3436111010	DLLA155PN118	
4	233-1161 (791Z48-4530C)	3436503010	DSLA147PN937	
5	0 432 193 566		DSLA145P975	
6	0 432 193 731		DSLA145P631	
7	0 432 193 691		DSLA139P710	
8	0 432 193 766		DSLA148P575	
9	0 432 193 835		DSLA145P366	
10	131406490	105148-1730	DN4PDN117	
11	131406500	105147-1740	DN4PDN117	





12	65642150232	070700/ WJ1S-50.8	D1Z1.042	
13	65646408630	070705/ WJ1S-78 7A	DOP150A2	
14	65687009910	096202	DSL150S428-1416	
15	65689009917	097482	DSL150S535-1417	
16	65771010884	080095/ WK4S-67.9	DSL160S430-1436	



LIAOCHENG COMMONRAIL AUTOPARTS CO., LTD

Nut For Commonrail Lists

	NO.	SIZE<Outer circle diameter×length×screw	Matched injector	Picture
1	1#	Φ16.9×31.25×M15	BOSCH: 110064、110356、110359	
2	2#	Φ18.8×34.7×M17	BOSCH: 12066、120067	
3	3#	Φ21×36.2×M19<Commonrails>	120078、120059、120123、120289、120393	
4	4#	Φ21×34.7×M19	120083、120110、120121、120122、120170、120215	
5	5#	Φ18.8×35×M17	110293、110313、110333、110335、110317、110466、110718	
6	6#	Φ20.9×34.7×M19雷诺	BOSCH:120106/309/310/232	
7	7#	A:Φ19.1×41.5×M17 B:Φ19.1×42×M17 C:Φ19.1×42.5×M17 D:Φ19.1×46×M17	DENSO: 0760、5800、6222、6510、6790、7060、23670、01010	

8	8#A	$\Phi 20.9 \times 43.35 \times M19$ <无槽、平头、磷化、 镀锌>	DENSO: 5511、 6700、8100	
9	8#B	$\Phi 21.3 \times 43.35 \times M19$ <有槽、平头、磷化、 镀锌>	DENSO: 5471	
10	9#A	$\Phi 21.3 \times 47.9 \times M19$ <有槽、圆头、磷化、 镀锌>	DENSO: 6353/6593	
11	9#B	$\Phi 21.3 \times 46.8 \times M19$ <无槽、圆头、镀锌>	DENSO: 5215/5226	
12	10#	Solenoid valve nut <磷化、黑色>	潍柴、锡柴系列	
13	11#	Solenoid valve nut <磷化、灰色>	Commins 120059/231/236/123	
14	12#	High-pressure double- head joint screw 高压双头接头螺钉	BOSCH: 120 series	
15	13#	High-pressure double- head joint screw 高压双头接头螺钉	BOSCH: 110系列 喷油器用	
16	14#	$\Phi 29.3 \times 31.8 \times M26$ (Solenoid valve nut)	CAT:320D	

17	15#	$\Phi 17.5 \times 45 \times M16$ (Nozzle nut)	CAT:320D	
18	16#	$\Phi 18.9 \times 41 \times M17$	Delphi	
19	17#	$\Phi 16.9 \times 41 \times M15.2$	Delphi	
20	18#	$\Phi 18.85 \times 34.7 \times M17$	Iveco	
21	19#	$\Phi 20.85 \times 34.7 \times M19$	Iveco	
22	20#	$\Phi 20.5 \times 35.2 \times M17$	Commins	
23	21#	$\Phi 33 \times 16 \times M31$	Commins	
24	22#	$\Phi 17.5 \times 45 \times M16$ (Nozzle nut)	320D改型油嘴紧帽 (GLB)	
25	23#	$\Phi 29.3 \times 32.5 \times M26$	320D改型电磁阀紧帽 (GLB)	

26	24#	$\Phi 17.5 \times 45 \times M16$ (Nozzle nut)	320D改型油嘴紧帽 (LF)	
27	25#	$\Phi 29.5 \times 32 \times M27$	320D改型电磁阀紧帽(LF)	
28	26#	$\Phi 38.25 \times 34.2 \times M35$		
29	27#	$\Phi 39 \times 90.8 \times M34Z$ (Nut for Pump Injector)	127-8216/127-8222/127-8213	
30	28#	$\Phi 39 \times 90.8 \times M34$ (Nut for Pump Injector)	127-8216/127-8222/127-8213	
31	29#	$\Phi 30.5 \times 9.7 \times M27$	110电磁阀扁帽	
32	30#	$\Phi 30.8 \times 20.5 \times M28 * 0.5$ 、 $M28 * 0.75$ (Solenoid valve nut)	0445120027/042/08 2	
33	31#	$\Phi 37.45 \times 85.3 \times M29$	CAT:C7/C9	
34	32#	$\Phi 39.35 \times 90.4 \times M33$	CAT:C13/C15	

35	33#	$\Phi 37.45 \times 82.3 \times M29$	CAT:C-9	
-----------	------------	---	----------------	---



LIAOCHENG COMMONRAIL AUTOPARTS CO., LTD

Control Rod Lists

NO.	Control rod	length (mm)	Outer circle diameter (mm)	Picture	
1	095000-1211	87.3	5		
2	095000-1212	66.5	5		
3	095000-1213	60.64	5		
4	095000-1214	79.33	5		
5	095000-1215	78	5		
6	095000-1216	78	5		
7	095000-1654	57.3	4.3		
8	095000-5212	67.3	4.3		
9	095000-5424	67.3	4.3		
10	095000-5230	79.2	4.3		
11	095000-5471	52.7	4.3		
12	095000-5471	52.7	4.3		
13	095000-5471	52.7	4.3		
14	095000-5471	52.7	4.3		
15	095000-5471	52.7	4.3		
16	095000-5471	52.7	4.3		
17	095000-5480	92.7	4.3		
18	095000-5511	85	4.3		
19	095000-4152	85	4.3		
20	095000-5511A	84.95	4.3		
21	095000-5941	76.9	4.3		
22	095000-5941	76.9	4.3		
23	095000-6070	93.5	4.3		
24	095000-6120	66.53	4.3		
25	095000-6471	66.7	4.3		
26	095000-6591	63.5	4.3		

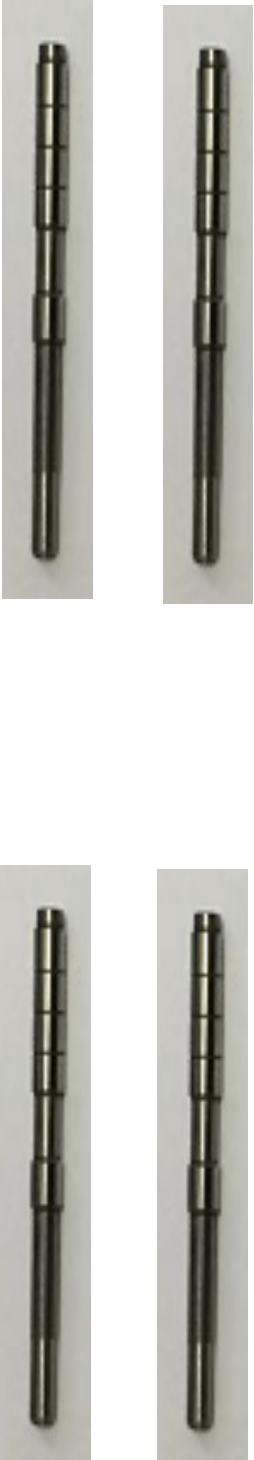
27	095000-6591	63.5	4.3	
28	095000-6591	63.5	4.3	
29	095000-6591	63.5	4.3	
30	095000-6591	63.5	4.3	
31	095000-6700	77.5	4.3	
32	095000-6700	77.5	4.3	
33	095000-6790	113	4.3	
34	095000-8100	90.4	4.3	
35	095000-8100	90.4	4.3	
36	095000-0541	71.25	4.3	
37	095000-5600	118.4	4.3	
38	095000-5635	56.3	4.3	
39	095000-6845	68.45	4.3	
40	095000-7100	71.0	4.3	
41	095000-7210	72.1	4.3	
42	095000-1089	61.3	7.3	
43	095000-6500	65	4.3	
44	Export 1	117.7	4.3	
45	Export 1	117.7	4.3	
46	Export 2	125.85	4.3	
47	Export 3	117.4	3.8	
48	Export 4	109.6	4.3	
49	7200	72		
50	8322	83.21		
51	5800	117.7		
52	5801	125.85		
53	6126	61.26		
54	G3	117.4		



LIAOCHENG COMMONRAIL AUTOPARTS CO., LTD

Relief Valve Lists

Number	Part Number	Engine Model	Pictures
1	095420-0140		
2	095420-0170		
3	095420-0190		
4	095420-0201		
5	095420-230		
6	095420-0260		
7	095420-0281		
8	095420-0320		
9	095420-0440		
10	095420-0550		
11	095420-0670		

12	1110010013		
13	1110010014		
14	1110010015		
15	1110010017		
16	1110010018		
17	1110010022		
18	1110010024		
19	1110010025		
20	1110010027		
21	1110010028		





LIAOCHENG COMMONRAIL AUTOPARTS CO., LTD

Solenoid For Commonrail Injector Lists

NO.	OEM NO.	Adaptable fuel injector assembly types			Picture
1	FO0VC30318	0445110183 0445110301 0445110313 0445110321 0445110334 0445110345 0445110355 0445110359 0445110376 0445110486 0445110594 0445110690 0445110710 0445110447 0445110780 0445110799	0445110291 0445110304 0445110317 0445110332 0445110335 0445110346 0445110357 0445110361 0445110454 0445110511 0445110623 0445110691 0445110752 0445110692 0445110792	0445110293 0445110305 0445110318 0445110333 0445110343 0445110347 0445110358 0445110365 0445110466 0445110512 0455110637 0445110629 0445110787 0445110735 0445110796	
2	FO0VC30319	0445110247 0445110281 0445110558	0445110356	0445110280 0445110442	
3	FO0RJ02697	0445120007 0445120020 0445120060 0445120122 0445120238 0445120041	0445120008 0445120040 0445120084 0445120123 0445120273 0445120134	0445120019 0445120059 0445120121 0445120236 0445120376	

4	FOORJ02703	0445120066 0445120067 0445120078 0445120081 0445120083 0445120086 0445120087 0445120102 0445120106 0445120110 0445120117 0445120127 0445120129 0445120130 0445120149 0445120150 0445120156 0445120160 0445120163 0445120164 0445120165 0445120166 0445120169 0445120170 0445120182 0445120183 0445120200 0445120213 0445120214 0445120215 0445120217 0445120225 0445120068 0445120161 0445120162	
5	FOORJ00395	0445120002	
6	FOOVC30057	0445110126 0445110290 0445110729	
7	FOOVC30058	0445110038 0445110059 0445110063 0445110084 0445110087 0445110091 0445110092 0445110102 0445110141 0445110185 0445110186 0445110221 0445110222 0445110223 0445110231 0445110279 0445110283 0445110306 0445110336	
8	FOOVC30054	0445110189 0445110035	
9	DENSO (电感: 145uH)	095000-5471 095000-6691 095000-6700 095000-6701 095000-8010 095000-5215 095000-6353 095000-5226 095000-6593 095000-5450 095000-6363 095000-6753 095000-6303	

10	DENSO (电感: 165uH)	095000-8011 095000-6222 095000-8871 23670-30400	095000-8100 095000-6250 0L090		
11	DENSO (电感: 145uH)	Suitable for 5550 injector			
12	DENSO (电感: 270uH)	0L050 0L010 23670-30300 095000-7781	23670-30050 095000-5880	23670-30280 095000-7761	
13	DENSO (电感: 145uH)	095000-5600 095000-6791	095000-6240	095000-6790	
14	DENSO (电感: 165uH)	适用电装国五G3喷油器, 095000-9690 1550/2900 1560/2870 1520/8630 5296723 2770 295050- 2470/2790/0232/0790/1600/2650/0920/1440/ 0491			
15	DENSO G2 (电感145uH)	适用于电装G2喷油器 095000-6980 弹簧室深度15.5mm			

16	DENSO G3 (电感165uH)	适用于电装G3喷油器 弹簧室深度16.35mm	
17	CAT	320D	
18	CAT	C7/C9/C-9	









LIAOCHENG COMMONRAIL AUTOPARTS CO., LTD

Bosch Control valve Lists

NO.	Valve No.	Injector No.	Pictures
1	F 00R J00 005	0 445 120 002/0986435501	
2	F 00R J00 218	0 445 120 003/004	
3	F 00R J00 339 F 00R J01 945	0 445 120 103/0 445 120 079/0986435505/032 0 445 120 018/113/0986435503/0 445 120 007	
4	F 00R J00 375	0 445 120 006	
5	F 00R J00 399		
6	F 00R J00 420		
7	F 00R J00 995		
8	F 00R J01 176		
9	F 00R J01 159	0 445 120 024/026/027	
10	F 00R J02 466	0 445 120 217/218/219/274/275/030	
11	F 00R J01 222		
12	F 00R J01 278	0 445 120 057/409/351/346/075/057/054	
13	F 00R J01 329	0 445 120 042	
14	F 00R J01 428	0 445 120 090/049/048	
15	F 00R J01 451	0 445 120 074	
16	F 00R J01 479	0 445 120 067/067	
17	F 00R J01 533		
18	F 00R J02 213 F 00R J01 612	0 445 120 040/041	
19	F 00R J01 657	0 445 120 396/395/247	
		0 445 120 124/263/396/393/378	
	F 00R J01 657	0 445 120 430/480/479	

20	F 00R J01 683	0 445 120 268/080
21	F 00R J01 692	0 445 120 153
		0 445 120 081/331/324
		0 445 120 130/129/149/150/227/244
		0 445 120 163/226/436/433/429/427
		0 445 120 446/357/503/502
		0 445 120 324
22	F 00R J01 704	0 445 120 392/245
23	F 00R J02 806	0 445 120 110/083/156/165/225/293
		0 445 120 304/377/304/489
		0 445 120 421
24	F 00R J01 714	0 445 120 356/342/336/332/071/184
	F 00R J02 004	0 445 120 269
25	F 00R J01 727	0 445 120 086/087/127/265/266/391/388
26	F 00R J01 747	0 445 120 082
27	F 00R J01 819	0 445 120 157/282/092/279/157/282
28	F 00R J01 865	
29	F 00R J01 924	0 445 120 296/102
30	F 00R J01 941	0 445 120 121/122/125/236/140/120
	F 00R J01 129	
31	F 00R J02 005	
32	F 00R J02 012	
	F 00R J02 035	0 445 120 397
		0 445 120 117/277
		0 445 120 145
		0 445 120 160/318
		0 445 120 215
		0 445 120 261



33		0 445 120 413	
		0 445 120 398	
		0 455 120 364	
		0 445 120 352	
		0 445 120 335	
		0 445 120 334	
		0 445 120 280	
		0 445 120 297	
		0 445 120 486	
		0 445 120 497	
34	F 00R J02 056	0 445 120 142/325	
		0 445 120 106/232/310/	
		0 445 120 339/309/232	
35	F 00R J02 067 F 00R J00 447 F 00R J01 895		
36	F 00R J02 103	0 445 120 361/360	
		0 445 120 415/321/445	
		0 445 120 416/297	
		0 445 120 134	
		0 445 120 372	
37	F 00R J02 130	0 445 120 123/255/250/238/328/256	
		0 445 120 273/212/0986435571	
38	F 00R J02 246	0 445 120 073	
39	F 00R J02 266	0 445 120 126	
40	F 00R J02 386		
41	F 00R J02 410 F 00R J02 044	0 445 120	
		179/180/197/201/202/220/229/311/	
		0 445 120 541/440	

42	F 00R J02 429	0 445 120 258
		0 445 120 233
		0 445 120 178
		0 445 120 494/493
		0 445 120 472
		0 445 120 448/447
43	F 00R J02 449	0 445 120 186/359/358/316/315/308
44	F 00R J02 454 F 00R J00 834	
45	F 00R J02 472	0 445 120 182/242
		0 445 120 329/289/367
		0 445 120 383
		0 445 120 403/402/400/399/382/371
46	F 00R J02 278	0 445 120 109/058
47	F 00R J02 506	0 445 120 305/257/199/181
48	F 00R J02 561	0 445 120 203
		0 445 120 557
		0 445 120 368/441
49	F 00R J02 714	
50	F 00R J03 556	0 445 120 501/387/370/481
		0 445 120 554
		0 445 120 463
51	F 00V C01 001	0 445 110 009/010/011/024/025/071/072/012
52	F 00V C01 003	
53	F 00V C01 005	
54	F 00V C01 007	
55	F 00V C01 011	
56	F 00V C01 013	



57	F 00V C01 015	
58	F 00V C01 016	
59	F 00V C01 022	
60	F 00V C01 023	
61	F 00V C01 024	
62	F 00V C01 033	0 445 110 762/763/730/186/279/283
63	F 00V C01 034	
64	F 00V C01 036	
65	F 00V C01 037	
66	F 00V C01 038	
67	F 00V C01 042	
68	F 00V C01 043	0 445 110 266/130/049/048/047
69	F 00V C01 044	
70	F 00V C01 045	0 445 110 095/096/105/106/107/170
71	F 00V C01 046	
72	F 00V C01 050	
73	F 00V C01 051	0 445 110 181/189/190/182
74	F 00V C01 052	
75	F 00V C01 053	
76	F 00V C01 054	
77	F 00V C01 301	
78	F 00V C01 303	
79	F 00V C01 305	
80	F 00V C01 309	0 445 110 054/255/129/128
81	F 00V C01 310	0 445 110 122/131
82	F 00V C01 313	
83	F 00V C01 315	



84	F 00V C01 317	
85	F 00V C01 318	
86	F 00V C01 383 F 00V C01 320	0 445 110 847/846
		0 445 110 594
		0 445 110 376
87	F 00V C01 321	
88	F 00V C01 324	0 445 110 162/163/294/295/656/194/193
89	F 00V C01 325	0 445 110 236/296/172
90	F 00V C01 328	
91	F 00V C01 329	0 445 110 467/315284/169/168
92	F 00V C01 331	0 445 110 216/301/219/212/
93	F 00V C01 334	0 445 110 183/316/331/578/765
94	F 00V C01 336	0 445 110 213 (0986435162)
95	F 00V C01 338	0 445 110 273/435/247/248
96	F 00V C01 340	
97	F 00V C01 341	
98	F 00V C01 342	
99	F 00V C01 344	
100	F 00V C01 345	
101	F 00V C01 346	0 445 110 257/258/725/253/254/726
102	F 00V C01 347	
103	F 00V C01 349	0 445 110 928/923/866/865/250/249
104	F 00V C01 352	0 445 110 852/850/724/274/275/278/277
105	F 00V C01 353	0 445 110 808/265
106	F 00V C01 354	0 445 110 899/898/297/281
107	F 00V C01 356	0 445 110 307
		0 445 110 944/943/942/941



108	F 00V C01 358	0 445 110 917/542/447/434/409/396	
		0 445 110 745	
		0 445 110 708/707	
		0 445 110 660/659/529/528/527/526/434	
		0 445 110 434/396	
		0 445 110 386/291	
		0 445 110 367/366	
109	F 00V C01 359	0 445 110 623	
		0 445 110 951/950	
		0 445 110 936/935	
		0 445 110 891/821/782	
		0 445 110 887	
		0 445 110 886/885/817/816/794/465	
		0 445 110 862/861/827/826/825/824	
		0 445 110 854/853/805/804	
		0 445 110 823	
		0 445 110 812/811/757/756	
		0 445 110 803/796	
		0 445 110 780	
		0 445 110 769	
		0 445 110 767/721	
		0 445 110 752/516	
		0 445 110 748/	
		0 445 110 719	
110	F 00V C01 360	0 445 B76/054/585/890/822	
		0 445 110 741	
		0 445 110 685/684	



110	F 00V C01 303	0 445 110 643/420/304
		0 445 110 482/317
		0 445 110 370/348
111	F 00V C01 365	0 445 110 864/863/860
		0 445 110 715/422/421
		0 445 110 511
		0 445 110 312
112	F 00V C01 367	0 445 110 677/676
113	F 00V C01 368	0 445 110 889/888
		0 445 110 868
		0 445 110 844/636/635/843/773/592
		0 445 110 733/568/567/
		0 445 110 390
		0 445 110 321
114	F 00V C01 371	0 445 110 544/383/333/334/372/333/723/534/544/6
115	F 00V C01 372	
116	F 00V C01 376	
117	F 00V C01 377	0 445 110 443
118	F 00V C01 380	0 445 110 634/375
119	F 00V C01 386	0 445 110 750/695/494/493/432/431
1	F 00R J02 377	0 445 120 327/422/408/376/327/167/295/451/ 443/451
2	F 00R J01 334	0 445 120 093/091/047
3	F 00R J02 397	0 445 120 243/095



4	F 00R J02 278	0 445 120 109/058
5	F 00R J02 397	0 445 120 243/095
6	F 00V C01 364	0 445 110 311
7	F 00V C01 306	0 445 110 444/441/436/215/214/085/153/154
8	F 00V C01 357	0 445 110 933/932/289
9	F 00V C01 360	0 445 110 460/327/299/308/300
1	F 00R J01 522	
2	F 00R J01 052	
3	F 00V C01 348	
4	F 00V C01 355	0445 110 280
5	F 00V C01 362	0445 110 303
6	F 00V C01 378	0445 110 377/378
7	F 00V C01 379	
8	F 00V C01 381	0445 110 374
9	F 00V C01 385	0445 110 353
10	F 00V C01 004	0445 110 030
11	F 00V C01 035	
12	F 00V C01 055	
13	F 00V C01 057	
14	F 00V C01 311	
15	F 00V C01 323	0445 110 167
16	F 00V C01 333	
17	F 00V C01 361	0445 110 288





LIAOCHENG COMMONRAIL AUTOPARTS CO., LTD

Commonrail Nozzle Lists

No.	Nozzle NO.	Injector NO.	Pictures
1	DSLA154P1320	0445110189	
2	DLLA145P2557	0445110808	
3	DLLA143P2365	0445110537	
4	DLLA143P1696	0445120127/389	
5	DLLA148P2516	0445120415	
6	DLLA154P2406	0445120368	
7	DLLA150 P2440	0445110629	
8	DLLA150P2439	0445110631	
9	DLLA150P2482	0445110694	
10	DLLA157P2508	0445110710	
11	DLLA149P2556	0445110805	
12	DLLA150P2572	0445110821	
13	DLLA151P2359	0445110531	
14	DLLA148P2497	0445110719	
15	DLLA148P2361	0445110516	
16	DLLA151P2488	0445110691	
17	DLLA143P2364	0445110515	
18	DLLA148P1809	0445110345	
19	DLLA150P2121	0445110355	
20	DLLA150P2434	0445110626	
21	DLLA158P2539	0445110792	
22	DLLA155P2547	0445110799	
23	DLLA148P2523	0445110757	
24	DLLA150P1666	0445110293/404/407	
25	DLLA153P715		
26	DLLA146P1296	0445110141	
27	DLLA148P2129	0445110365	
28	DLLA150P2272	0445110454	
29	DLLA150P2436	0445110632	
30	DLLA153P2351	0445110541	
31	DLLA140P2281	0445110465	
32	DLLA82P1668	0445110305/521	
33	DLLA147P1702	0445110313	
34	DLLA145P926+	0445110266	
35	DLLA145P928	0445110049	
36	DSLA143P5501	0445120212	
37	DSLA128P5510	0445120231	

38	DSLA128P1510	0445120059
39	DSLA140P1723	0445120123
40	DSLA140P1142	0445110145
41	DLLA118P2203	0445120236
42	DLLA144P1707	0445120122
43	DLLA142P1709	0445120121
44	DLLA154P1418	0445120045
45	DLLA144P1565	0445120066
46	DLLA146P1581	0445120067
47	DLLA150P1566	0445120138
48	DLLA150P2142	0445120242
49	DLLA150P2386	0445120357
50	DLLA148P2221	0445120265
51	DLLA148P2222	0445120266
52	DLLA145P2397	0445120361
53	DLLA147P2474	0445120391
54	DLLA145P1655	0445120388/086
55	DLLA146P1339	0445120218
56	DLLA142P2262	0445120289
57	DLLA152P1819	0445120170/224
58	DLLA152P1768	0445120149/213/214
59	DLLA150P1622	0445120078/393
60	DLLA149P2166	0445120215
61	DLLA151P2240	0445120277/397
62	DLLA150P1781	0445120150/244
63	DLLA152P2344	0445120343
64	DLLA150P2197	0445120247/395
65	DLLA148P1688	0445120110
66	DLLA135P1747	0445120126
67	DLLA152P1690	0445120083
68	DLLA150P1826	0445120160
69	DLLA141P2146	0445120134
70	DLLA151P1656	0445120081
71	DLLA148P1815	0445120290
72	DLLA148P2369	0445120321
73	DLLA150P2282	0445120294
74	DLLA145P2168	0445110376
75	DLLAP147P1814	0445120153
76	DLLA127P2402	0445120367
77	DLLA148P1524	0445120217
78	DLLA149P2345	0445120344
79	DLLA153P1721	0445120106/310
80	DLLA153P2189	0445120232/309

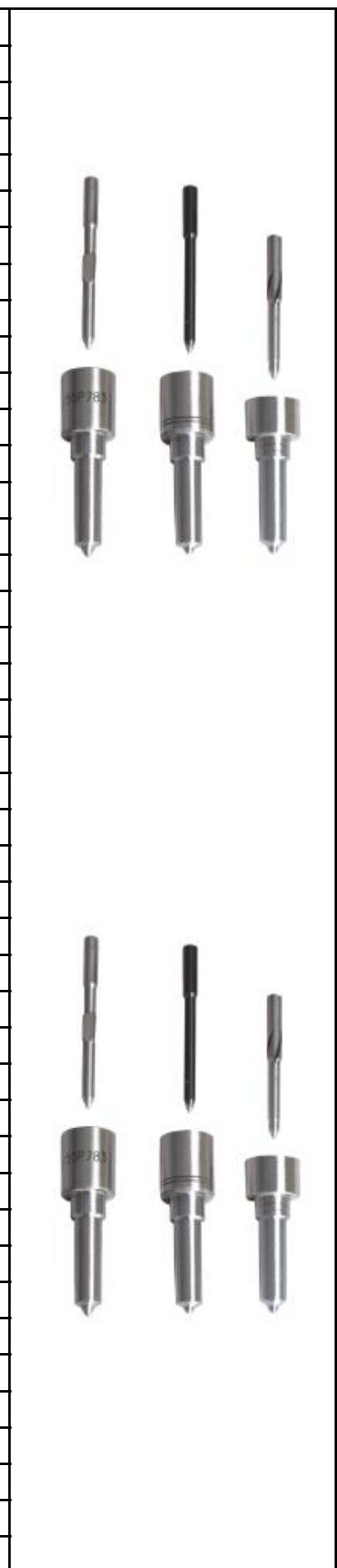

81	DLLA140P1790	0445120141
82	DLLA143P2155	0445120204
83	DLLA150P2153	0445120178
84	DLLA146P2487	0445110690
85	DLLA150P2616	0445110891
86	DLLA150P2596	0445110862
87	DLLA150P2156	0445110380
88	DLLA82P1773	0445110512
89	DLLA150P1808	0445110412
90	DLLA145P2431	0445110623
91	DLLA150P2362	0445110538
92	DSLA143P5519	0445120255
93	DSLA143P5499	0445120210
94	DSLA124P1659	0445120114/0445120103
95	DSLA124P5500	0445120208
96	DSLA124P5516	0445120238
97	DSLA158P974	0445120008
98	DLLA158P1500	0445120042
99	DLLA159P1611	0445120082
100	DLLA146P2563	0445120459
101	DLLA152P2422	0445120373
102	DLLA145P2566	0445120461/555
103	DLLA149P2568	0445120462
104	DLLA150P2489	0445110696
105	DLLA153P2546	0445110796
106	DLLA156P2470	0445110677
107	DLLA149P2593	0445110854
108	DLLA120P2613	0445120489
109	DLLA152P2348	0445110527
110	0445110449	DLLA150P1812
111	DSLA143P1058	0445120113/0445120018
112	DLLA146P2145	0445120193
113	DLLA148P2158	0445120281
114	DLLA127P1098	RE543266
115	DLLA127P944	095000-6310/RE530362
116	DLLA139P887	RE529118
117	DLLA142P852	095000-1211
118	DLLA145P1024	30300
119	DLLA145P1049	095000-8011
120	DLLA145P864	30050
121	DLLA145P870	095000-5600
122	DLLA145P875	095000-5760/8110
123	DLLA147P788	095000-0770/0940



124	DLLA148P816	095000-5070/5130	
125	DLLA148P828	095000-5230	
126	DLLA148P915	095000-6070	
127	DLLA148P932	095000-6240	
128	DLLA150 P835	095000-5215	
129	DLLA150P1026/966	30310	
130	DLLA150P1032	095000-7510	
131	DLLA150P1052	095000-8100	
132	DLLA150P1113	095000-9690/6800	
133	DLLA150P866	095000-5550/8310	
134	DLLA150P927/905	095000-5942	
135	DLLA151P1089	095000-8920	
136	DLLA152P1040	095000-8370	
137	DLLA152P1071	095000-6480	
138	DLLA152P862	095000-5430/6100	
139	DLLA152P865/1097	095000-5512	
140	DLLA152P879	095000-6480	
141	DLLA152P929	095000-5513/6300	
142	DLLA152P947	095000-6253	
143	DLLA152P980	095000-6980	
144	DLLA152P981	095000-6990	
145	DLLA153P884	095000-5800	
146	DLLA153P885	095000-7060/5810	
147	DLLA153P977	095000-6693	
148	DLLA155P1025	095000-7781/7731	
149	DLLA155P1030	095000-7490/9560	
150	DLLA155P1062	0L050	
151	DLLA155P1090/964	095000-6791	
152	DLLA155P842	095000-6353	
153	DLLA155P848	095000-6593	
154	DLLA155P863	095000-5921	
155	DLLA155P965	095000-6700	
156	DLLA156P799	095000-5007	
157	DLLA156P910	095000-5972	
158	DLLA157P855	095000-5450	
159	DLLA158P1096/854	095000-5471	
160	DLLA158P834	095000-5226/5222	
161	DLLA158P844/1092	095000-5345/6366	
162	G3S6	295050-018X 295050-020X 295050-046X 295050-052X	
163	G3S33		



164	G3S52		
165	DLLA125P889		
166	DLLA154P988		
167	DSLA136P804		
168	DLLA156P850		
169	DSLA145P763 +		
170	DLLA160P1063+		
171	DSLA154P1034		
172	DLLA150P758		
173	DSLA154P1129/		
174	DLLA150P1011		
175	DLLA157P964		
176	DLLA156P1107+		
177	DLLA142P1333		
178	DSLA140P1033/		
179	DSLA142P1474		
180	DSLA156P737		
181	DSLA143P970		
182	DSLA156P1411		
183	DSLA137P793		
184	DLLA151P771		
185	DLLA155P767		
186	DLLA156P1114		
187	DLLA156P1367		
188	DLLA150P1197		
189	DSLA150P1102		
190	DLLA157P649		
191	DLLA145P978		
192	DLLA153P1270+		
193	DSLA156P736		
194	CP0210 858703 V 0602 2801 MP144		
195	DLLA148P1067		
196	DSLA142P795		
197	DSLA124P1309		
198	DLLA150P1224		
199	DLLA150P1437		
200	DLLA156P1368		
201	DLLA148P817		
202	CP0509825864 V0203P152 909		
203	D - DLLA158P854		
204	DSLA150P706		
205	DSLA150P1250		
206	CP0631775794 P142		



207	DLLA150P952	
208	DLLA150P1512	
209	DSLA144P971	
210	DSLA144P1021	
211	DSLA145P1091	
212	DSLA156P1079/+	
213	DLLA156P1509	
214	CP0634 281 929	
215	CP0611229583	
216	ALLA147P747-J	
217	DSLA150P1248	
218	DSLA150P783	
219	CP06 192 47384 M0006 P154	
220	DLLA146P1545	
221	DSLA156P1155+	
222	DLLA150P1151	
223	DLLA142P1595	
224	DLLA149P1471/	
225	DLLA153P1322	
226	DLLA150P1614	
227	DLLZ147S1083	
228	CP08308 84778 M0006 P154 116	
229	DLLA144P1565	
230	DLLA160P1308	
231	DLLA154P2178	
232	DLLA160P1415	
233	DSLA150P1156	
234	DSLA150P1247	
235	DLLA148P1524/	
236	DLLA153P1494	
237	DLLA149P1515/	
238	CP06 137 35048 V0605 P144 684	
239	CP13246 16933 M0011 P162 192	
240	CP12299 76106 M0604 P142 524	
241	CP0435077389 V0802 P150 383	
242	DLLA157P1777	
243	DLLA145P1698	
244	DLLA152P1832/	
245	DLLA146P1581	
246	DLLA152P1077+	
247	DSLA146P1409+	
248	DLLA152P1525	
249	DLLA150P1744	



250	DLLA152P1681	
251	DLLA162P2160+	
252	DLLA148P1671	
253	DLLA150P2125	
254	DLLA150P2259	
255	DLLA150P1828	
256	DLLA145P2573	
257	DLLA150P1827	
258	DLLA145P1738	
259	DLLA153P2210	
260	DLLA152P2217	
261	DLLA151P2182	
262	DLLA145P1720	
263	DLLA152P2350	
264	DLLA146P2161	
265	DLLA155P1674	
266	DLLA144P2273	
267	DLLA150P1803	
268	DLLA148P2538	
269	DLLA162P2266	
270	DLLA146P1610	
271	DLLA155P2264	
272	DLLA150P2126	
273	DLLA144P1417	
274	DLLA152P1609	
275	DLLA150P1373	
276	DLLA143P2206	
277	DLLA158P1385	
278	DSLA144P1295	
279	DSLA145P979	
280	DLLA146P1783	
281	DLLA145P1804	
282	M0011 P162 304	
283	M0604 P142 696	
284	DLLA143P1535	
285	DLLA150P1076	





LIAOCHENG COMMONRAIL AUTOPARTS CO., LTD

Denso orifice plate Lists

No.	Item	Injector No.	Pictures
1	02#	095000-5212/5215/5226/5512/5513/5391 295040-6230	
2	04#	095000- 5550/5950/5053/5220/6590/6311/6312/5030/7850/7893/649 0/6491/6950 095000-5030/6351/6793/6791	
3	05#	BF11X11E-058250 11E-505757 23670-30010/30020 D56204M0104/23670-30030/27030 (11R00176) /095000- 0570/094#/095#/077#/063#/0402	
4	06#	095000-8480/23670-51031	
5	07#	23670-30050/095000-5810/095000-5881/095000-5660 23670-0L050/095000-8290/095000-8220/095000-8560 095000-778X/23670-30280/23670-39185/23670- 39215/23670-39315/23670-39310/ 23670-30140/23670-30220/23670-09070 23670-30300/095000-7760/095000-7761/095000- 7751/095000-7750/23670-39276 23670-0L010/23670-0L070/095000--8740/23670-09360	
6	10#	095000-6593/095000-6951/095000-6952/095000-6594 095000-5550/095000-8310 095000-6353/095000-6350/095000-6352 095000-6491/095000-6490/095000-6492/RE529118 095000-6310/095000-6311/RE530362 095000-5800 095000-7060/6C1Q-9K546-BC RE529149/095000-6480 095000-8940/RE543266 095000-5600/1465A041 095000-956x/1465A257	
7	18#	095000-0260/5450/5454/6860/6821/9720	
8	19#	095000- 5230/5341/5342/5344/5470/5471/5472/5473/5474/5475/547 6/6374/6382/6392 095000- 5480/5481/5500/5501/5502/5511/5931/6363/6364/6366/611 1/6300/6420/6430 095000- 8740/8901/8902/8903//6900/8900/5600/5619/5650/5690/81 70/8930/8970 095000-5931/6931/7257/7611/3930/0660/23670- 09360/30050	

9	21#	13H50
10	29#	095000-5511/5514/5515/5516
		095000-5459/5489
11	31#	095000-6222/6223/6693/6691/6700/6701/6790
		095000-8010/8011/8100 295040-6770
12	32# (28#)	095000-5760/6770/6070/1211 612006N0683 295040-6120 8-98203849-ODMX
13	34#	095000- 8633/8163/8300/6652/8971/2491/6303/4363/6270/254
14	36#	095000-6790/6791/6793/6693
15	501#	095000-0231/23670-30190
16	504#/505#	095000- 0231/0152/0491/1290/4351/0650/6022/3490/7880/059 1/0452/0352/1930/1570
		095000-4990/7193/7870
17	507#	23670-0L110/23670-09380/295050-054#/SM295050-0810
		23670-0L090/294050-0521
		23670-30400/295050-0460
18	509#	7193/7870
19	517#	095000-1440
20	VP12	095000-5650/6521/6240/6241/6243 16600- VMOOD/VM00A/MB40#/MB40A DCR1106240
21	F03 (BGC2	23670-30420/0L090/30143/0L100
22	F23 (SFP6	095000-5801/5800/6Q10C/ 1465A054
23	orifice p	095000-0560/0562/0942/5880/6366





LIAOCHENG COMMONRAIL AUTOPARTS CO., LTD

Control valve Lists

No.	Contral No.	Injector NO.	Pictures
1	28392662	28342997/R00001D	
2	28277576	28264951	
3	28264094	28230891	
4	28525582	28229873	
5	28256383	28231014	
6	28400213	28400214/28534718	
7	9308Z625C	R001101D	
8	28362727	28319895	
9	28346624	R00301D	
10	28265514		
11	28439531	28236381	
12	28297165	28239766	
13	28397897	28559935	
14	28631942		
15	28430285	28437695	
16	28651415		
17	28651416		
18	28343134	28307309	
19	9308-622B		
20	9308-621C		
21	28239294		
22	28239295		



LIAOCHENG COMMONRAIL AUTOPARTS CO., LTD

Samll Parts Lists

No.	Series	Part number	the pictures of details
1	Metering valve	7123-490AE	
2		7123-490AH	
3		7123-490AR	
4		7123-490E	
5		7123-490F	
6		7123-718F	
7		7123-835F	
8		7123-930G	
9		7123-781K	
10		7139-559AF	
11		7139-559D	
12		7139-559E	
13		7139-559H	
14		7139-559M	
15		7139-559P	
16		7139-559S	
17		7180-321A	
18		7180-935A	
19		7180-321C	
20		7180-935C	
21		7180-321E	
22		7180-935E	
23		7180-321L	
24		7182-621C	
25		7182-621E	
26		7182-621F	
27		7182-621G	
28		7182-621T	
29		9050-355	

30	Transfer pump rotor	7123-018F	
31		7123-018G	
32		7123-018D	
33		7123-018E	
34		7182-245	
35		7182-245A	
36	Roller & shoe kit	7135-072N	
37		7135-72	
38	Actuator kit	7206-0486	
39	Control valve	For CAT 320D	



LIAOCHENG COMMONRAIL AUTOPARTS CO., LTD

VE ROTOR HEAD

NO	Original number	Specification	Matching models	Remarks
1	096400-0143	4/9R	ISUZU 1.5T FORKLIFT 4FE1	10
2	096400-0232	4/10R	mitsubishi 4D5T	10.1
3	096400-0242	4/9R	TOYOTA 2C	10
4	096400-0262	4/12R	KOMATSU 4D95L	12.1
5	096400-0371	4/10R	TOYOTA 2L	10.1
6	096400-0432	4/12R	TOYOTA 1Z	12.1
7	096400-1000	4/10R		10.1
8	096400-1030	4/9R	MITSUBISHI 4D6	10
9	096400-1060	4/9R	TOYOTA 3B (1090)	10
10	096400-1090	4/9R	TOYOTA 1DZ	10
11	096400-1160	4/10R		10.1
12	096400-1210	6/12R	TOYOTA 11Z 13Z	12.1
13	096400-1220	4/12R	KOMATSU 4D95S	12.1
14	096400-1230	4/12R	TOYOTA 1Z	12.1
15	096400-1240	4/12R	TOYOTA 14B D850	12.1
16	096400-1250	4/10R	TOYOTA 3L	10.1
17	096400-1270	4/10R	TOYOTA 2C-T	10.1
18	096400-1300	4/10R	TOYOTA 1DZ	10.1
19	096400-1320	6/12R	TOYOTA 1HD-T	12.1
20	096400-1330	6/10R	TOYOTA 1HZ	10.1
21	096400-1390	4/10R		10.1
22	096400-1441	4/12R	TOYOTA 1KZ	12.1
23	096400-1480	4/10R	TOYOTA 2L-TE	10.1
24	096400-1500	6/10R	TOYOTA 1HZ	10.1
25	096400-1580	4/12R		12.1

Pictrue



26	096400-1590	4/10R		10.1
27	096400-1600	4/11L	ISUZU 4JB1	12
28	096400-1610	4/10L		10.1
29	096400-1670	6/12R		12.1
30	096400-1680	3/9R	TOYOTA 3B	10
31	096400-1690	4/12R	TOYOTA 2Z	12.1
32	096400-1700	6/12R		12.1
33	096400-1730	4/10R	8F 1DZ NISSAN	10.1
34	096400-1740	4/10R		10.1
35	096400-1770	4/10R		10.1
36	096400-1800	6/12R		12.1
37	096400-1860	4/12R		12.1
38	096400-1890	4/10R		10.1
39	096400-1950	4/11R	NISSAN	12.1
40	146400-2220	4/10R	mitsubishi 4D55	12
41	146400-4520	4/10R	ISUZU 4FC1	12
42	146400-5521	4/9L	ISUZU C223	10
43	146400-5820	4/10L		12
44	146400-8821	4/9L	ISUZU 3T tractor shovel	10
45	146400-9720	4/10R	NISSAN LD20T	12
46	146401-0221	4/10R		12
47	146401-0520	4/10R	NISSAN AD23 TD27 (2120)	12
48	146401-1920	4/9L	ISUZU C240	10
49	146401-2020	4/10R		12
50	146401-2120	4/10R	NISSAN AD27	12
51	146401-3020	4/12R	KOMATSUForklift 4D95 4D94	14
52	146401-3220 9 461	4/10R	(1620)	12
53	146401-34209 461	4/10R		12
54	146401-3520	4/10L	TD23 10Z	12
55	146401-36209 461	4/10R		12
56	146401-37209 461	4/10R		12
57	146401-4220	4/11R	NISSAN QD32 FENGXING MITSUBISHIS4S	12
58	146401-44209 461	4/12R	DAEWOOForklift DB33A	14



59	146401-4720	4/10R		12
60	146402-0820	4/11R	ISUZU 4JB1、4BC2	12
61	146402-0920	4/11L	ISUZU 4JA1、4JB1	12
62	146402-1420	4/12R	ISUZU 3 T Truck4BE1 (02-4320)	14
63	146402-1520	4/10R	ISUZU D201-02	10.1
64	146402-2420	4/11L	ISUZU 4JB1CG	12
65	146402-25209 461	4/11R		12
66	146402-3420	4/11R	498 engine/NISSAN BD30	12
67	146402-3820	4/11L	ISUZU TRCCK 4JA1	12
68	146402-4020	4/12L	493ZQ (2200)	14
69	146402-4320	4/12R	ISUZU 3T TRUCK 4BE1	14
70	146402-4420	4/12L	ISUZU 4JA1	14
71	146402-4720	4/11L	ISUZU 4JB1-TC (9 461 615 973)	12
72	146402-5120	4/11L	Ford Transit	12
73	146402-5220	4/11L		12
74	146402-5720	4/12R		14
75	146403-0520	4/10R		12
76	146403-12209 461	4/8R		10
77	146403-2820	4/10R	MAZADA ED33	12
78	146403-3120	4/10L	NISSAN CD17	12
79	146403-3320	4/10R	NISSAN CD35	12
80	146403-3420	4/10L		12
81	146403-3520	4/10R	NISSAN TD27	12
82	146403-37209 461	4/11R		12
83	146403-4220	4/10L		12
84	146403-4720	4/10R		12
85	146403-48209 461	4/11L	ISUZU 4JG2 TOYOTA forklift	12
86	146403-4920	4/11R	MITSUBISHI	12
87	146403-6120	4/11R		12
88	146403-6620	4/11R		12
89	146403-6820	4/10L	MAZADA WLT	12
90	146403-6920	4/10R	(9620)	12
91	146403-7420	4/11R	MITSUBISHI	12



92	146403-7920	4/10L		12
93	146403-8720	4/10R	Terracan Electronic control	12
94	146403-9221	4/10L		12
95	146403-95209 461 6	4/10R		12
96	146403-9620	4/10R		12
97	146403-9720	4/11R	CAT307	12
98	146404-1620	4/10R	Refine	12
99	146404-2200	4/12L	ISUZU	14
100	146405-04219 461 6	6/11R	Korea Daewoo	12
101	146405-06209 461 6	6/12R	(06-0820)	14
102	146405-1920	6/10R	NISSAN TD42	12
103	146405-37209 461 6	6/11R		12
104	146405-4020	6/10R		12
105	146405-4220	6/11R	NISSAN TD42T (05-4420)	12
106	146405-44209 461 6	6/11R		12
107	146406-0620	6/11R	6D95L KOMATSU	12
108	146406-0820	6/12R	KOMATSUForklift	14
109	146407-00209 461 6	6/10R		10
110	146408-0420	6/10R		12
111	146408-0620	6/10R		12
112	923402-0904	4/10R	Forklift、Yuchai little excavator	12
113	YK205	4/12R		13
114	YK206	4/11L		12
115	YK209	4/11L		12
116	YK210	4/11R		12
117	YK214	4/10R		10.1
118	YK215	4/11L		12
119	YK400	4/12L		13
120	YK661	4/11L	Jin Ning oII Nozzle 148P042	12
121	YK662	4/11L	Jin Ning oII	12
122	YK666	4/11R		12
123	KIA2700	4/10L		12
124	KIA	4/10L		12



125	ASIA	6/11R		12
126	YK B3-90	3/9L		10
127	1 468 333 323	3/11L	Filyat GEOTECH	12
128	1 468 333 335	3/11R		12
129	1 468 333 342	3/11L		12
130	1 468 334 009	4/11L	ISUZU	12
131	1 468 334 012	4/12R	(4648)	13
132	1 468 334 013	4/12R	Liebherr	13
133	1 468 334 014	4/12R		13
134	1 468 334 017	4/9R		10
135	1 468 334 018	4/11R		12
136	1 468 334 032	4/11R		12
137	1 468 334 066	4/12L		13
138	1 468 334 313	4/9R	IEVCO 40-8	10
139	1 468 334 327	4/9R	Volkswagen CR, JK (4565)	10
140	1 468 334 337	4/10R	Ford York (4480)	12
141	1 468 334 378	4/12R	KOMMINS 4BT (construction machinery)	13
142	1 468 334 391	4/10R		12
143	1 468 334 456	4/12L	(4033)	13
144	1 468 334 472	4/11L		12
145	1 468 334 475	4/12R	POKINS Phaser 70	13
146	1 468 334 480	4/10R		12
147	1 468 334 485	4/11R	IEVCO40-10 (4603)	12
148	1 468 334 496	4/12R	KOMMINS 4BT AA (bus)	13
149	1 468 334 564	4/8R	Volkswagen/AUDI 1Y LINDERForklift	10
150	1 468 334 565	4/9R	Volkswagen/AUDI JK	10
151	1 468 334 575	4/9R	Volkswagen ME	10
152	1 468 334 580	4/11R	(4799, 4859)	12
153	1 468 334 592	4/11L	AURIFULL	12
154	1 468 334 594	4/12R		12
155	1 468 334 595	4/11R	IEVCO	12
156	1 468 334 603	4/11R	IEVCO 40-10 High emission	12
157	1 468 334 604	4/11R	IEVCO	12



158	1 468 334 606	4/11R	IEVCO	12
159	1 468 334 611	4/9R		10
160	1 468 334 617	4/11R	(4798、4844)	13
161	1 468 334 625	4/12R		13
162	1 468 334 631	4/10L		12
163	1 468 334 647	4/12R		13
164	1 468 334 648	4/12R	KOMMINS 4BTAA/Yangzhou Yaxing	13
165	1 468 334 653	4/12R		13
166	1 468 334 654	4/12R		13
167	1 468 334 672	4/12R	POKINS Oman cavalry	13
168	1 468 334 713	4/12R	MAN	13
169	1 468 334 717	4/8R		10
170	1 468 334 720	4/11R	IEVCO	12
171	1 468 334 768	4/9R		10
172	1 468 334 780	4/11R	IEVCO	12
173	1 468 334 784	4/12R		13
174	1 468 334 798	4/11R	IEVCO40-10	12
175	1 468 334 799	4/11R		12
176	1 468 334 810	4/12R		13
177	1 468 334 841	4/11R	IEVCO	12
178	1 468 334 844	4/11R		12
179	1 468 334 851	4/11R		12
180	1 468 334 859	4/11R		12
181	1 468 334 870	4/12R	(4899)	13
182	1 468 334 873	4/12R		13
183	1 468 334 874	4/12R		13
184	1 468 334 882	4/11R		12
185	1 468 334 889	4/11R	RENAULT S9W 700	12
186	1 468 334 899	4/12R		13
187	1 468 334 900	4/12R		13
188	1 468 334 925	4/12R	IEVCO	13
189	1 468 334 928	4/11L		12
190	1 468 334 946	4/11R	IEVCO	12



191	1 468 334 960	4/12R	(4994)	13
192	1 468 334 964	4/8R	LINDERForklift	10
193	1 468 334 982	4/12R		13
194	1 468 334 987	4/11R		12
195	1 468 334 993	4/12R		13
196	1 468 334 994	4/12R		13
197	1 468 335 338	5/11R		12
198	1 468 335 345	5/10R	AUDI CN	12
199	1 468 335 348	5/8L	(5365)	10
200	1 468 335 351	5/9L		10
201	1 468 335 365	5/8L		10
202	1 468 336 343	6/10L		12
203	1 468 336 352	6/12L	POKINS	13
204	1 468 336 364	6/12R	MAN D0230 MKF/170	13
205	1 468 336 403	6/12R	KOMMINS	13
206	1 468 336 420	6/10R		12
207	1 468 336 423	6/12R	KOMMINS 6BT	13
208	1 468 336 440	6/10L		12
209	1 468 336 451	6/12R	POKINS	13
210	1 468 336 453	6/12L		13
211	1 468 336 457	6/11R	IEVCO	12
212	1 468 336 464	6/12R	POKINS Phaser160T	13
213	1 468 336 468	6/10L		12
214	1 468 336 480	6/12R	KOMMINS 6BT 5.9	13
215	1 468 336 499	6/12R	POKINS	13
216	1 468 336 513	6/12R	T007 T003 (6655)	13
217	1 468 336 601	6/12R		12
218	1 468 336 602	6/12R	POKINS	13
219	1 468 336 606	6/12R	KOMMINS 6BTAA 5.9 (6636)	13
220	1 468 336 607	6/12R		13
221	1 468 336 608	6/12R		13
222	1 468 336 614	6/12R		13
223	1 468 336 622	6/12L		13



224	1 468 336 623	6/12R		13
225	1 468 336 626	6/12L	POKINS 6352	13
226	1 468 336 636	6/12R	Yuchai6108 DAFCN 95	13
227	1 468 336 637	6/11R	IEVCO	12
228	1 468 336 642	6/12R		13
229	1 468 336 647	6/12R	CDC 6BTA 5.9 HYUNDAI Excavator	13
230	1 468 336 655	6/12R		13
231	1 468 336 801	6/12R		13
232	1 468 336 806	6/12R		13
233	1 468 373 004	3/12L		13
234	1 468 373 011	3/12R		13
235	1 468 373 012	3/12L		13
236	1 468 374 012	4/11R		12
237	1 468 374 015	4/12R		13
238	1 468 374 016	4/12R	Dongfeng storica (4024)	13
239	1 468 374 019	4/12R	Yuchai 、 (4110)	13
240	1 468 374 020	4/12L	(4028)	13
241	1 468 374 024	4/12R	KOMMINS bus	13
242	1 468 374 032	4/11R		12
243	1 468 374 033	4/12L		13
244	1 468 374 036	4/12L		13
245	1 468 374 037	4/12R		13
246	1 468 374 041	4/12R	IEVCO2.8L	13
247	1 468 374 042	4/11R		12
248	1 468 374 047	4/11L	Jiangling luck	12
249	1 468 374 053	4/12R	POKINS	13
250	1 468 374 064	4/12R		13
251	1 468 374 066	4/11L		12
252	1 468 374 099	4/12L		13
253	1 468 376 001	6/12R	CNH TM140	13
254	1 468 376 002	6/12R	KOMMINS (6008)	13
255	1 468 376 003	6/12R	Yuchai、 (6105)	13
256	1 468 376 005	6/12R	KOMMINS (6027、6037)	13



257	1 468 376 007	6/12R		13
258	1 468 376 008	6/12R	KOMMINS	13
259	1 468 376 010	6/12L		13
260	1 468 376 013	6/12L		13
261	1 468 376 017	6/12R		13
262	1 468 376 021	6/12R		13
263	1 468 376 023	6/12R		13
264	1 468 376 028	6/12R		13
265	1 468 376 033	6/12R		13
266	1 468 376 037	6/12R		13
267	1 468 376 042	6/11L		12
268	1 468 376 248	6/12R		13
269	1 468 376 668	6/12R	POKINS	13
270	2 468 334 043	4/9R		10
271	2 468 334 066	4/11R		12
272	2 468 334 091	4/10R	FAW Jetta	12
273	2 468 335 044	5/11R		12
274	2 468 335 047	5/11L		12
275	2 468 336 013	6/10R	BME 25 6 T1	12
276	2 468 336 020	6/10R		12
277	2 468 336 029	6/12L		13
278	9 461 080 408	4/11R		12
279		4/10R	DAEWOO Excavator	12
280		4/10R	HYUNDAI Excavator	12
281		4/10R	Korandot, South Korea	12
282	149701-05209 443	4/8.5R	Mitsubishi Pajero 4M41	





LIAOCHENG COMMONRAIL AUTOPARTS CO.,LTD

DPA ROTOR HEAD

No.	Product Code	Rotor number	sleeve number	Barrel number	Specificati on	Note	small plunger	Solenoid	Rotor nut	pictrue
1	7123-340J	344J	343	558A	4/6. 5R	DPA	2	no	7123-018F	
2	7123-340M	344M	343	342A	4/7. 5L	DPA	2	no	7123-018G	
3	7123-359M 7180-578M	344M	361	582A	4/7. 5L	DPA	2	no	7123-018G	
4	7123-340R 7180-550R	344R	343	558A	4/8. 5L	DPA	2	no	7123-018G	
5	7123-340S 7180-550S	344S	343	558A	4/8. 5R	DPA	2	no	7123-018F	
6	7123-345T 7180-559T	349T	348	577A	6/9L	DPA	2	no	7123-018G	
7	7123-909T 7180-571T	908T	906	577B	6/9L	DPA	2	no	7123-018G	
8	7123-340U 7180-550U	344U	343	558A	4/9R	DPA	2	no	7123-018F	
9	7123-345U 7180-559U	349U	348	577A	6/9R	DPA	2	no	7123-018F	
10	7123-909U 7180-571U	908U	906	577B	6/9R	DPA	2	no	7123-018F	
11	7123-909V 7180-571V	908V	906	577B	6/9. 5L	DPA	2	no	7123-018G	

12	7123-340W 7180-550W	344W	343	558A	4/9. 5R	DPA	2	no	7123-018F
13	7139-235G	858Q	348	880	3/8R	DPA	2	no	7123-018F
14	7139-235S	858S	348	880A	3/8. 5R	DPA	2	no	7123-018F
15	7139-764S 7180-616S	708S	766	620A	3/8. 5R	DPA	2	no	7123-018F
16	7139-130T	344T	343	558B	4/9L	DPA	2	no	7123-018G
17	7139-764T 7180-616T	708T	766	620A	3/9L	DPA	2	no	7123-018G
18	7139-360U 7180-560U	189U	348	577A	6/9R	DPA	2	no	7123-018F
19	7139-709W 7180-611W	708W	706	615A	3/9. 5R	DPA	2	no	7123-018F
20	7139-92Y	91Y	906	347B	6/10R	DPA	2	no	7123-018F
21	7180-600L	800L	226	596B	4/7R	DPA	4	no	7123-018F
22	7180-645L	344L	652	649A	4/7R	DPA	2	yes	7123-018F
23	7180-655L	36L	840	657B	6/7R	DPA	4	yes	7123-018F
24	7180-700L	800L	171	702B	4/7R	DPA	4	yes	7182-245
25	7180-720L	241L	242	724B	4/7R	DPA	4	yes	7123-018F
26	7180-727L	36L	840	725B	6/7R	DPA	4	yes	7182-245
27	7180-728L	800L	171	730B	4/7R	DPA	4	yes	7123-018F
28	7180-965L	895L	171	957	4/7R	DPA	4	yes	7182-245
29	7180-967L	955L	840	959	6/7R	DPA	4	yes	7182-245
30	7180-973L	976L	975	979	3/7R	DPA	4	yes	7182-245
31	7180-650S	708S	810	654A	3/8. 5R	DPA	2	yes	7123-018F
32	7180-668S	344S	991	677A	4/8. 5R	DPA	2	yes	7123-018F
33	7180-977S	981S	980	979	3/8. 5R	DPA	2	yes	7182-245
34	7180-647U	344U	652	649B	4/9R	DPA	2	yes	7123-018F



35	7180-668U	344U	991	677A	4/9R	DPA	2	yes	7123-018F
36	7180-698U	344U	652	702B	4/9R	DPA	2	yes	7123-018F
37	7180-722U	248U	246	724B	4/9R	DPA	2	yes	7123-018F
38	7180-750U	278U	254A	752B	6/9R	DPA	2	yes	7123-018F
39	7180-819U	820U	246	724B	4/9R	DPA	2	yes	7123-018F
40	7180-854U	853U	343	558A	4/9R	DPA	2	yes	7123-018F
41	7180-613W	708W	706	615B	3/9.5R	DPA	2	no	7123-018F
42	7180-668W	344W	991	677A	4/9.5R	DPA	2	yes	7123-018F
43	7180-759W	344W	226	596A	4/9.5R	DPA	2	no	7123-018F
44	7180-572Y	91Y	906	577B	6/10R	DPA	2	no	7123-018F
45	7183-121K	527K	521	119B	3/7L	DPS	4	yes	7123-018G
46	7183-128K	528K	517	131B	4/7L	DPS	4	yes	7123-018G
47	7183-129K	043K	517	131B	4/7L	DPS	4	yes	7182-245A
48	7183-136K	466K	521	139B	4/7L	DPS	4	yes	7182-245A
49	7183-113L	436L	435	115A	4/7R	DPS	4	yes	7182-245
50	7183-125L	528L	671	127B	4/7R	DPS	4	yes	7123-018F
51	7183-156L	878L	769	158B	6/7R	DPS	4	yes	7123-018F
52	7183-165L	528L	783	167B	4/7R	DPS	4	yes	7123-018F
53	7183-182L	829L	631	135B	6/7R	DPS	4	yes	7123-018F
54	7183-742L	344L	223	746A	4/7R	DPS	2	yes	7123-018F
55	7184-083L	976L	984	986	3/7R	DPA	4	yes	7182-245
56	7185-023L	511L	677	025B	6/7R	DP200	4	no	7182-245
57	7185-044L	043L	408	038B	4/7R	DPT	4	yes	7182-245
58	7185-101L	256L	254	103B	6/7R	DP200	4	yes	7123-018F
59	7185-114L	314L	315	103B	6/7R	DP200	4	yes	7182-245
60	7185-196L	481L	059	123B	6/7R	DP200	4	yes	7182-245
61	7185-197L	482L	408	038B	4/7R	DP200	4	yes	7182-245
62	7185-626L	269L	DPS866	872	6/7R	DPT	4	yes	7182-245



63	7185-627L	326L	868	877	3/7R	DP200	4	yes	7182-245
64	7185-706L	326L	871	877	3/7R	DP200	4	yes	7182-245
65	7185-906L	326L	871	895	3/7R	DP200	4	yes	7182-245
66	7185-913L	326L	868	895	3/7R	DP200	4	yes	7182-245
67	7185-917L	345L	863	893	6/7R	DP200	4	yes	7182-245
68	7185-918L	328L	864	896	4/7R	DP200	4	yes	7182-245
69	7185-919L	345L	869	893	6/7R	DPT	4	yes	7182-245
70	7185-127U	318U	242	085B	4/9R	DPT	2	yes	7182-245
71	7189-267K	004K	054	061	4/7L	DP200	4	yes	7182-245A
72	7189-522K	528K	515	466	4/7L	DPT	4	yes	7182-245A
73	7189-039L	004L	051	061	4/7R	DP200	4	yes	7182-245
74	7189-187L	943L	106	128	6/7R	DP200	4	yes	7182-245
75	7189-340L	159L	326	155	4/7R	DPT	4	yes	7182-245
76	7189-376L	004L	326	061	4/7R	DP200	4	yes	7182-245
77	7189-878L	018L	411	412	3/7R	DP200	4	yes	7182-245
78	9002-232L	641L	734	733	4/7R	DPA	2	yes	7123-018F
79	9050-191L	800L	188	A702B	4/7R	DPA	4	yes	7123-018F
80	9050-222L	511L	224	093B	6/7R	DP200	4	yes	7182-245
81	9050-228L	215L	231	229B	4/7R	DP200	4	yes	7182-245
82	9050-300L	215L	231	085B	4/7R	DPT	4	yes	7182-245
83	9050-304L	502L	306	088B	3/7R	DPT	4	yes	7182-245
84	9094-404S	708S	706	409A	3/8.5R	DPA	2	yes	7123-018F
85	9187-210A	210A	540	210A	3/7R	DP200	4	yes	7182-245
86	527K	527K	521	717B	3/7L	DPS	4	yes	7123-018G
87	528K	528K	517	516B	4/7L	DPS	4	yes	7123-018G
88	15L	15L	435	115A	4/7R	DPS	4	yes	7182-245
89	215L SI	215L	343	029B	4/7R	DP200	4	no	7182-245
90	547L	547L	226A	958	4/7R	DPA	4	yes	7123-018F



91	800L CI	800L	181	180B	4/7R	DPA	4	yes	7123-018F
92	927S	927S	810	958LT	3/8. 5R	DPA	2	yes	7182-245
93	344W	344W	044	683A	4/9. 5R	DPA	2	yes	7123-018F
94	91Y	91Y	906	757	6/10R	DPA	2	no	7123-018F
95	28302134	528K	8680	2132	4/7L	DPT	4	yes	7182-245A
96	28385103	019L	2406	2405	6/7R	DPT	4	yes	7182-245
97	23403730	3724	224	3726	6/7L	DPT	4	yes	7182-245A





LIAOCHENG COMMONRAIL AUTOPARTS CO.,LTD

DENSO REPAIR KIT

IMAGE		
PART NUMBER	095000-5474/5471/8903	095000-6353
APPLIED INJECTOR	Nozzle: DLLA158P854/DLLA158P1096 Orifice plate: 1 200 803 Control rods:1 200 701 (ZP50)	Nozzle: DLLA155P848 Orifice plate: 1 200 804 Control rods:1 200 705 (ZP9)

IMAGE		
PART NUMBER	095000-6593	095000-5511/5513
APPLIED INJECTOR	Nozzle: DLLA155P842 Orifice plate: 1 200 804 Control rods:1 200 705 (ZP9)	Nozzle: DLLA152P865 Orifice plate: 1 200 804 Control rods:1 200 706 (ZP53)





IMAGE		
PART NUMBER	095000-6364	095000-6366
APPLIED INJECTOR	Nozzle: DLLA158P844 Orifice plate: 1 200 804 Control rods:1 200 701 (ZP50)	Nozzle: DLLA158P1092 Orifice plate: 1 200 804 Control rods: 1 200 701 (ZP50)

IMAGE		
PART NUMBER	095000-6700/6701	095000-6791
APPLIED INJECTOR	Nozzle: DLLA155P965 Orifice plate:1 200 805 Control rods1 200 703 (ZP11)	Nozzle: DLLA155P1090 Orifice plate: 1 200 802 Control rods1 200 704 (ZP52)

BOSCH REPAIR KIT



IMAGE		
PART NUMBER	F00RJ03281	F00RJ03282
APPLIED INJECTOR	<p>Injector: 0445120078 Nozzle: DLLA150P1622 Valve: F00R J01 657 Sealing ring: BRI200-00-009 Support ring: BRI200-00-010 Ball guidance: BRI200-00-008</p>	<p>Injector: 0445120110/0445120292 Nozzle: DLLA148P1688 Valve: F00R J02 806 Sealing ring: BRI200-00-009 Support ring: BRI200-00-010 Ball guidance: BRI200-00-008</p>



IMAGE		
PART NUMBER	F00RJ03283	F00RJ03284
APPLIED INJECTOR	<p>Injector: 0445120170 0445120224 Nozzle: DLLA152P1819 Valve: F00R J01 692 Sealing ring: BRI200-00-009 Support ring: BRI200-00-010 Ball guidance: BRI200-00-008</p>	<p>Injector: 0445120002 Nozzle: DSLA136P804 Valve: F00R J00 005 Sealing ring: BRI200-00-009 Support ring: BRI200-00-010 Ball guidance: BRI200-00-008</p>



IMAGE		
PART NUMBER	F00RJ03285	F00RJ03286
APPLIED INJECTOR	<p>Injector: 0445120081/0445120331 Nozzle: DLLA151P1656 Valve: F00R J02 056 Sealing ring: BRI200-00-009 Support ring: BRI200-00-010 Ball guidance: BRI200-00-008</p>	<p>Injector: 0445120106/0445120310 Nozzle: DLLA153P1721 Valve: F00R J02 056 Sealing ring: BRI200-00-009 Support ring: BRI200-00-010 Ball guidance: BRI200-00-008</p>



IMAGE		
PART NUMBER	F00RJ03287	F00RJ03288
APPLIED INJECTOR	<p>Injector:0445120265 Nozzle: DLLA148P2221 Valve: F00R J01 727 Sealing ring: BRI200-00-009 Support ring: BRI200-00-010 Ball guidance: BRI200-00-008</p>	<p>Injector: 445120134 Nozzle: DLLA141P2146 Valve: F00R J02 103 Sealing ring: BRI200-00-009 Support ring: BRI200-00-010 Ball guidance: BRI200-00-008</p>



IMAGE		
PART NUMBER	F00RJ03285	F00RJ03286
APPLIED INJECTOR	Injector:0445120081/0445120331 Nozzle: DLLA151P1656 Valve: F00R J02 056 Sealing ring: BRI200-00-009 Support ring: BRI200-00-010 Ball guidance: BRI200-00-008	Injector: 0445120106/0445120310 Nozzle: DLLA153P1721 Valve: F00R J02 056 Sealing ring: BRI200-00-009 Support ring: BRI200-00-010 Ball guidance: BRI200-00-008



IMAGE		
PART NUMBER	F00RJ03287	F00RJ03288
APPLIED INJECTOR	Injector:0445120265 Nozzle: DLLA148P2221 Valve: F00R J01 727 Sealing ring: BRI200-00-009 Support ring: BRI200-00-010 Ball guidance: BRI200-00-008	Injector: 445120134 Nozzle: DLLA141P2146 Valve: F00R J02 103 Sealing ring: BRI200-00-009 Support ring: BRI200-00-010 Ball guidance: BRI200-00-008



IMAGE		
PART NUMBER	F00RJ03289	F00RJ03290
APPLIED INJECTOR	<p>Injector: 0445120215 Nozzle: DLLA149P2166 Valve: F00R J02 035 Sealing ring: BRI200-00-009 Support ring: BRI200-00-010 Ball guidance: BRI200-00-008</p>	<p>Injector: 0445120149/0445120213 Nozzle: DLLA152P1768 Valve: F00R J01 692 Sealing ring: BRI200-00-009 Support ring: BRI200-00-010 Ball guidance: BRI200-00-008</p>



IMAGE		
PART NUMBER	F00RJ03472	F00RJ03475
APPLIED INJECTOR	<p>Injector: 0445120083 Nozzle: DLLA152P1690 Valve: F00RJ02806 Sealing ring: BRI200-00-009 Support ring: BRI200-00-010 Ball guidance: BRI200-00-008</p>	<p>Injector: 0445120086 Nozzle: DLLA145P1655 Valve: F00R J01 727 Sealing ring: BRI200-00-009 Support ring: BRI200-00-010 Ball guidance: BRI200-00-008</p>



IMAGE		
PART NUMBER	F00RJ03488	F00RJ03491
APPLIED INJECTOR	<p>Injector: 04451201300445120222 Nozzle: DLLA149P1724 Valve: F00R J01 692 Sealing ring: BRI200-00-009 Support ring: BRI200-00-010 Ball guidance: BRI200-00-008</p>	<p>Injector: 04451201500445120244 Nozzle: DLLA150P1781 Valve: F00R J01 692 Sealing ring: BRI200-00-009 Support ring: BRI200-00-010 Ball guidance: BRI200-00-008</p>



IMAGE		
PART NUMBER	F00RJ03493	F00RJ03494
APPLIED INJECTOR	<p>Injector: 0445120160 Nozzle: DLLA150P1826 Valve: F00R J02 035 Sealing ring: BRI200-00-009 Support ring: BRI200-00-010 Ball guidance: BRI200-00-008</p>	<p>Injector: 0445120163/0445120226 Nozzle: DLLA150P1826 Valve: F00R J01 692 Sealing ring: BRI200-00-009 Support ring: BRI200-00-010 Ball guidance: BRI200-00-008</p>



IMAGE		
PART NUMBER	F00RJ03495	F00RJ03504
APPLIED INJECTOR	<p>Injector: 0445120225 Nozzle: DLLA150P2259 Valve: F00R J02 806 Sealing ring: BRI200-00-009 Support ring: BRI200-00-010 Ball guidance: BRI200-00-008</p>	<p>Injector: 0445120227/ 0445120228 Nozzle: DLLA151P2182 Valve: F00R J01 692 Sealing ring: BRI200-00-009 Support ring: BRI200-00-010 Ball guidance: BRI200-00-008</p>



IMAGE		
PART NUMBER	F00RJ03507	F00RJ03510
APPLIED INJECTOR	<p>Injector: 0445120242,0445120183 Nozzle: DLLA150P2142 Valve: F00V CO1 367 Sealing ring: BRI200-00-009 Support ring: BRI200-00-010 Ball guidance: BRI200-00-008</p>	<p>Injector: 0445120242,0445120183 Nozzle: DLLA150P2142 Valve: F00R J01 727 Sealing ring: BRI200-00-009 Support ring: BRI200-00-010 Ball guidance: BRI200-00-008</p>



IMAGE		
PART NUMBER	F00RJ03487	F00RJ03496
APPLIED INJECTOR	<p>Injector: 0445120200/0445120223 0445120129/0445120221 Nozzle: DLLA146P1725 Valve: F00R J01 692 Sealing ring: BRI200-00-009 Support ring: BRI200-00-010 Ball guidance: BRI200-00-008</p>	<p>Injector: 445120289 Nozzle: DLLA142P2262 Valve: F00V CO1 367 Sealing ring: BRI200-00-009 Support ring: BRI200-00-010 Ball guidance: BRI200-00-008</p>



IMAGE		
PART NUMBER	F00RJ03515	F00RJ03521
APPLIED INJECTOR	<p>Injector:0445120289 Nozzle: DLLA142P2262 Valve: F00V CO1 367 Sealing ring: BRI200-00-009 Support ring: BRI200-00-010 Ball guidance: BRI200-00-008</p>	<p>Injector: 445120304 Nozzle: DLLA144P2273 Valve: F00R J02 806 Sealing ring: BRI200-00-009 Support ring: BRI200-00-010 Ball guidance: BRI200-00-008</p>



IMAGE		
PART NUMBER	F00RJ03509	F00RJ03468
APPLIED INJECTOR	<p>Injector: 0445120247 Nozzle: DLLA150P2197 Valve: F00R J01 657 Sealing ring: BRI200-00-009 Support ring: BRI200-00-010 Ball guidance: BRI200-00-008</p>	<p>Injector: 445120059 Nozzle: DSLA128P1510 Valve: F00R J02 130 Sealing ring: BRI200-00-009 Support ring: BRI200-00-010 Ball guidance: BRI200-00-008</p>



IMAGE		
PART NUMBER	F00RJ03535	F00RJ03539
APPLIED INJECTOR	<p>Injector: 0445120321 Nozzle: DLLA148P2369 Valve: F00V CO1 367 Sealing ring: BRI200-00-009 Support ring: BRI200-00-010 Ball guidance: BRI200-00-008</p>	<p>Injector: 0445120329 Nozzle: DLLA143P2319 Valve: F00R J02 103 Sealing ring: BRI200-00-009 Support ring: BRI200-00-010 Ball guidance: BRI200-00-008</p>



IMAGE		
PART NUMBER	F00RJ03545	F00RJ03546
APPLIED INJECTOR	<p>Injector: 0445120357 Nozzle: DLLA150P2386 Valve: F00R J01 692 Sealing ring: BRI200-00-009 Support ring: BRI200-00-010 Ball guidance: BRI200-00-008</p>	<p>Injector: 0 445120361 Nozzle: DLLA145P2397 Valve: F00R J02 103 Sealing ring: BRI200-00-009 Support ring: BRI200-00-010 Ball guidance: BRI200-00-008</p>



IMAGE		
PART NUMBER	F00RJ03548	F00RJ04101
APPLIED INJECTOR	<p>Injector: 445120343 Nozzle: DLLA152P2344 Valve :F00R J01 692 Sealing ring: BRI200-00-009 Support ring: BRI200-00-010 Ball guidance: BRI200-00-008</p>	<p>Injector: 0445110376 0445110594 Nozzle: DLLA145P2168 Valve: F00V C01 383 Sealing ring: BRI200-00-009 Support ring: BRI200-00-010 Ball guidance: BRI200-00-008</p>



IMAGE		
PART NUMBER	F00RJ04105	F00RJ04144
APPLIED INJECTOR	<p>Injector: 0445110537 Nozzle: DLLA143P2365 Valve:F00V CO1 359 Sealing ring: BRI200-00-009 Support ring: BRI200-00-010 Ball guidance: BRI200-00-008</p>	<p>Injector: 0445110317 0445110482 Nozzle: DLLA145P1720 Valve:4c Sealing ring: BRI200-00-009 Support ring: BRI200-00-010 Ball guidance: BRI200-00-008</p>



IMAGE		
PART NUMBER	F00RJ04107	F00RJ04108
APPLIED INJECTOR	<p>Injector: 0445110537 Nozzle: DLLA143P2365 Valve:F00V CO1 359 Sealing ring: BRI200-00-009 Support ring: BRI200-00-010 Ball guidance: BRI200-00-008</p>	<p>Injector: 0445110629 0445110628 Nozzle: DLLA150P2440 Valve:F00V CO1 359 Sealing ring: BRI200-00-009 Support ring: BRI200-00-010 Ball guidance: BRI200-00-008</p>



IMAGE		
PART NUMBER	F00RJ04109	F00RJ04110
APPLIED INJECTOR	<p>Injector: 0445110631,0445110630 Nozzle: DLLA150P2439 Valve:F00V CO1 359 Sealing ring: BRI200-00-009 Support ring: BRI200-00-010 Ball guidance: BRI200-00-008</p>	<p>Injector:0445110672 Nozzle: DLLA143P2472 Valve:F00V CO1 359 Sealing ring: BRI200-00-009 Support ring: BRI200-00-010 Ball guidance: BRI200-00-008</p>



IMAGE		
PART NUMBER	F00RJ04145	F00RJ04114
APPLIED INJECTOR	<p>Injector:0445110291/0445110409 Nozzle: DLLA155P1674 Valve :F00V CO1 334 Sealing ring: BRI200-00-009 Support ring: BRI200-00-010 Ball guidance: BRI200-00-008</p>	<p>Injector: 0445110721 Nozzle: DLLA143P2500 Valve:F00V CO1 359 Sealing ring: BRI200-00-009 Support ring: BRI200-00-010 Ball guidance: BRI200-00-008</p>



IMAGE		
PART NUMBER	F00RJ04118	F00RJ04119
APPLIED INJECTOR	<p>Injector: 0445110633/0445110632 Nozzle: DLLA150P2436 Valve: F00V CO1 359 Sealing ring: BRI200-00-009 Support ring: BRI200-00-010 Ball guidance: BRI200-00-008</p>	<p>Injector: 0445110694 Nozzle: DLLA150P2482 Valve: F00V CO1 359 Sealing ring: BRI200-00-009 Support ring: BRI200-00-010 Ball guidance: BRI200-00-008</p>



IMAGE		
PART NUMBER	F00RJ04121	F00RJ04148
APPLIED INJECTOR	<p>Injector: 0445110293 0445110407 Nozzle: DLLA150P1666 Valve: F00V CO1 359 Sealing ring: BRI200-00-009 Support ring: BRI200-00-010 Ball guidance: BRI200-00-008</p>	<p>Injector: 0445110313/0445110446 0445110445/0445110443 Nozzle: DLLA147P1702 Valve: F00V CO1 359 Sealing ring: BRI200-00-009 Support ring: BRI200-00-010 Ball guidance: BRI200-00-008</p>



IMAGE		
PART NUMBER	F00RJ04123	F00RJ04124
APPLIED INJECTOR	<p>Injector:0445110719 Nozzle: DLLA148P2497 Valve: F00V CO1 359 Sealing ring: BRI200-00-009 Support ring: BRI200-00-010 Ball guidance: BRI200-00-008</p>	<p>Injector:0445110356 Nozzle: DLLA150P2125 Valve: FOOV C01 365 Sealing ring: BRI200-00-009 Support ring: BRI200-00-010 Ball guidance: BRI200-00-008</p>



IMAGE		
PART NUMBER	F00RJ04125	F00RJ04126
APPLIED INJECTOR	<p>Injector: 0445110486 Nozzle: DLLA150P2327 Valve:FOOV C01 365 Sealing ring: BRI200-00-009 Support ring: BRI200-00-010 Ball guidance: BRI200-00-008</p>	<p>Injector:0445110487 Nozzle: DLLA150P2340 Valve:FOOV C01 365 Sealing ring: BRI200-00-009 Support ring: BRI200-00-010 Ball guidance: BRI200-00-008</p>



IMAGE		
PART NUMBER	F00RJ04127	F00RJ04128
APPLIED INJECTOR	<p>Injector: 0445110335/0445110512 Nozzle: DLLA82P1773 Valve: F00V CO1 359 Sealing ring: BRI200-00-009 Support ring: BRI200-00-010 Ball guidance: BRI200-00-008</p>	<p>Injector: 0445110817 Nozzle: DLLA151P2567 Valve: F00V CO1 359 Sealing ring: BRI200-00-009 Support ring: BRI200-00-010 Ball guidance: BRI200-00-008</p>



IMAGE		
PART NUMBER	F00RJ04129	F00RJ04130
APPLIED INJECTOR	<p>Injector: 0445110412/0445110343 Nozzle: DLLA150P1808 Valve: F00V CO1 359 Sealing ring: BRI200-00-009 Support ring: BRI200-00-010 Ball guidance: BRI200-00-008</p>	<p>Injector:0445110794 0445110717/0445110718 0445110466/0445110465 Nozzle: DLLA140P2281 Valve: F00V CO1 359 Sealing ring: BRI200-00-009 Support ring: BRI200-00-010 Ball guidance: BRI200-00-008</p>



IMAGE		
PART NUMBER	F00RJ04131	F00RJ04132
APPLIED INJECTOR	<p>Injector: F00RJ04131 Nozzle: DLLA157P2508 Valve: F00V CO1 359 Sealing ring: BRI200-00-009 Support ring: BRI200-00-010 Ball guidance: BRI200-00-008</p>	<p>Injector:0445110466 Nozzle: DLLA140P2281 Valve: F00V CO1 359 Sealing ring: BRI200-00-009 Support ring: BRI200-00-010 Ball guidance: BRI200-00-008</p>



IMAGE		
PART NUMBER	F00RJ04151	F00RJ04134
APPLIED INJECTOR	<p>Injector:0445110691 Nozzle: DLLA151P2488 Valve :F00V CO1 359 Sealing ring: BRI200-00-009 Support ring: BRI200-00-010 Ball guidance: BRI200-00-008</p>	<p>Injector: 0445110715 Nozzle: DLLA150P2499 Valve: FOOV C01 365 Sealing ring: BRI200-00-009 Support ring: BRI200-00-010 Ball guidance: BRI200-00-008</p>



IMAGE		
PART NUMBER	F00RJ04135	F00RJ04136
APPLIED INJECTOR	<p>Injector: 0445110511 Nozzle: DLLA150P2339 Valve: F00V C01 365 Sealing ring: BRI200-00-009 Support ring: BRI200-00-010 Ball guidance: BRI200-00-008</p>	<p>Injector: 0445110422 0445110421 Nozzle: DLLA138P2246 Valve F00V C01 365 Sealing ring: BRI200-00-009 Support ring: BRI200-00-010 Ball guidance: BRI200-00-008</p>



IMAGE		
PART NUMBER	F00RJ04137	F00RJ04138
APPLIED INJECTOR	<p>Injector: 0445110318, 0445110361 Nozzle: DLLA156P1719 Valve:F00R J02 472-81W Sealing ring: BRI200-00-009 Support ring: BRI200-00-010 Ball guidance: BRI200-00-008</p>	<p>Injector: 0445110527 0445110526 Nozzle: DLLA152P2348 Valve:F00V CO1 358-81W Sealing ring: BRI200-00-009 Support ring: BRI200-00-010 Ball guidance: BRI200-00-008</p>



IMAGE		
PART NUMBER	F00RJ04139	F00RJ04140
APPLIED INJECTOR	<p>Injector: 0445110359/0445110358 Nozzle: DLLA150P2126 Valve:F00V CO1 358-81W Sealing ring: BRI200-00-009 Support ring: BRI200-00-010 Ball guidance: BRI200-00-008</p>	<p>Injector: 0445110359/0445110358 Nozzle: DLLA150P2126 Valve:F00V CO1 358-81W Sealing ring: BRI200-00-009 Support ring: BRI200-00-010 Ball guidance: BRI200-00-008</p>



IMAGE		
PART NUMBER	F00RJ04141	F00RJ04142
APPLIED INJECTOR	<p>Injector: 0445110660/0445110659 Nozzle: DLLA145P2461 Valve:F00V CO1 358-81W Sealing ring: BRI200-00-009 Support ring: BRI200-00-010 Ball guidance: BRI200-00-008</p>	<p>Injector: 0445110677/0445110676 Nozzle: DLLA156P2470 Valve:F00R J02 472-81W Sealing ring: BRI200-00-009 Support ring: BRI200-00-010 Ball guidance: BRI200-00-008</p>



IMAGE		
PART NUMBER	F00RJ04144	F00RJ04145
APPLIED INJECTOR	<p>Injector: 0445110317/0445110482 Nozzle: DLLA145P1720 Valve: F00V CO1 363 Sealing ring: BRI200-00-009 Support ring: BRI200-00-010 Ball guidance: BRI218-00-008</p>	<p>Injector: 0445110291/0445110409 Nozzle: DLLA155P1674 Valve: F00V CO1 358-81W Sealing ring: BRI200-00-009 Support ring: BRI200-00-010 Ball guidance: BRI218-00-008</p>



IMAGE		
PART NUMBER	F00RJ04148	F00RJ04151
APPLIED INJECTOR	<p>Injector: 0445110313 0445110446/0445110445 Nozzle: DLLA147P1702 Valve: F00V CO1 359 Sealing ring: BRI200-00-009 Support ring: BRI200-00-010 Ball guidance: BRI218-00-008</p>	<p>Injector: 0445110691 Nozzle: DLLA151P2488 Valve: F00V CO1 359 Sealing ring: BRI200-00-009 Support ring: BRI200-00-010 Ball guidance: BRI218-00-008</p>



IMAGE		
PART NUMBER	F00RJ04152	F00RJ04153
APPLIED INJECTOR	<p>Injector: 0445110365 0445110364</p> <p>Nozzle: DLLA148P2129</p> <p>Valve: F00V CO1 359</p> <p>Sealing ring: BRI200-00-009</p> <p>Support ring: BRI200-00-010</p> <p>Ball guidance: BRI218-00-008</p>	<p>Injector: 0445110757 0445110756</p> <p>Nozzle: DLLA148P2523</p> <p>Valve: F00V CO1 359</p> <p>Sealing ring: BRI200-00-009</p> <p>Support ring: BRI200-00-010</p> <p>Ball guidance: BRI218-00-008</p>



IMAGE		
PART NUMBER	F00RJ04155	F00RJ04156
APPLIED INJECTOR	<p>Injector: 0445110333 0445110383/0445110372</p> <p>Nozzle: DLLA150P1803</p> <p>Valve: F00V C01 371-81W</p> <p>Sealing ring: BRI200-00-009</p> <p>Support ring: BRI200-00-010</p> <p>Ball guidance: BRI218-00-008</p>	<p>Injector: 0445110692</p> <p>Nozzle: DLLA151P2479</p> <p>Valve: F00V C01 371-81W</p> <p>Sealing ring: BRI200-00-009</p> <p>Support ring: BRI200-00-010</p> <p>Ball guidance: BRI218-00-008</p>



IMAGE		
PART NUMBER	F00RJ04160	F00RJ04161
APPLIED INJECTOR	<p>Injector: 0445110417 0445110416 Nozzle: DLLA155P2226 Valve: F00V CO1 359 Sealing ring: BRI200-00-009 Support ring: BRI200-00-010 Ball guidance: BRI218-00-008</p>	<p>Injector: 0445110449 Nozzle: DLLA150P1812 Valve: F00V CO1 359 Sealing ring: BRI200-00-009 Support ring: BRI200-00-010 Ball guidance: BRI218-00-008</p>



IMAGE		
PART NUMBER	F00RJ04162	F00RJ04164
APPLIED INJECTOR	<p>Injector: 0445110799 0445110798 Nozzle: DLLA155P2547 Valve: F00V CO1 359 Sealing ring: BRI200-00-009 Support ring: BRI200-00-010 Ball guidance: BRI218-00-008</p>	<p>Injector: 0445110787 Nozzle: DLLA158P2539 Valve: F00V CO1 359 Sealing ring: BRI200-00-009 Support ring: BRI200-00-010 Ball guidance: BRI218-00-008</p>

IMAGE	
PART NUMBER	F00RJ04165
APPLIED INJECTOR	Injector: 0445110623 Nozzle: DLLA145P2431 Valve: F00V CO1 359 Sealing ring: BRI200-00-009 Support ring: BRI200-00-010 Ball guidance: BRI218-00-008