

DIN FITTINGS

DIN 2353 METRIC BITE-TYPE FITTINGS AND ADAPTERS
DIN 标准接头





公司简介

1953年, L. Mike Brennan即公司创始人, 布劳宁先生离开了工作多年的岗位, 在美国俄亥俄州注册了以自己姓氏命名的公司“Brennan Industries Inc.”, 开始为客户生产和仓储各种液压管接件。在办公室进门的位置, 布劳宁先生专门订制了一个铜框, 并刻下了“以客户为家人”的公司理念, 确保每位员工上班时都能看到。这一年布劳宁公司的产品库存目录清单上有了300种美标产品。

6年后, 布劳宁先生的女婿——David D. Carr先生的加入, 加快了家族企业的发展。布劳宁公司的产品线从最初的美标接头迅速扩展至仪器仪表接头&阀门、阀组产品、SAE法兰及美标卡套产品, 仓库覆盖美国东西海岸线、石油开采区及重工业开发区域。在此期间, David D. Carr先生创新性地引入了大数据预测生产系统, 配合领先的加工生产规模, 彻底消除了客户因传统接单模式而产生的等货与存货的烦恼。在David D. Carr先生管理公司的几十年间, 独特的布劳宁模式和客户一起经历了各类经济危机与行业震荡。通过保障每位客户的产品及时供应, 消除客户的呆滞库存, 降低客户90%以上的库存成本, 布劳宁取得了飞速发展。自2014年起, 布劳宁液压管接件北美地区销售总量连续多年名列前茅。

如今, 布劳宁公司家族第三代成员David M. Carr先生正在带领公司走向全球化。目前布劳宁公司在北美、亚洲和欧洲设有5家生产制造中心, 14个战略仓库, 拥有包括美标、德标 (DIN标准), 英标 (BS标准) 与日标 (JIS标准) 等不同品种与规格的50,000多种产品库存。高效扁平的管理模式, 简单实用的经营理念, 让全球数百个行业的30,000多家客户最终选择使用布劳宁公司的产品和服务。

自成立以来, 布劳宁一直坚持非常严格的质量控制措施, “以客户为家人”的创始理念让每位家族成员及每位布劳宁人始终坚持以最高标准进行生产及质量监控。布劳宁生产制造中心都通过了ISO 9001、IATF 16949、AS9100D、NADCAP等一种或多种质量体系认证, 多年来布劳宁也一直是多家航空航天、核电、铁路、石油化工等要求极为严苛的企业的合格供应商。

目前布劳宁在中国的长期协议客户得到的额外服务包括但不限于:

- 协议库存产品, 随时按实际需求数量订货, 没有起订量限制
- 协议库存产品订单后24小时内发货, 72小时内到货或在指定时间到货
- 布劳宁全球14个仓库可任意调用产品
- 随时依据行业周期调整备货数量
- 突发订单优先加急处理
- 专业技术支持、包括设计支持、三维模型提供、产品优化
- 非标产品设计和订制服务
- 布劳宁全球分销商团队的售后质量服务支持

布劳宁公司期待更多的客户加入布劳宁大家庭, 享受布劳宁公司提供的更加安全, 更有保障的供应支持。欢迎联系 sheilawang@brennanchina.com 或本地布劳宁公司分销商获取更多布劳宁公司详细信息。



目录

螺母和卡套

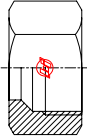
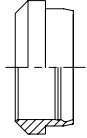
TNT 	KO 
卡套螺母 P07	渐进式卡套 P08

管/管连接

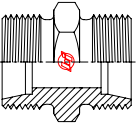
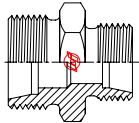
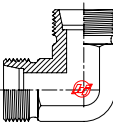
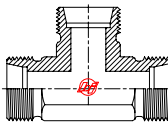
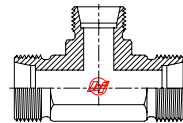
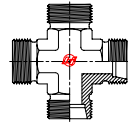
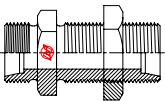
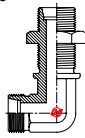
00TT 	00TT 	90TT 	TTT 	TTT 	TTTT 
直通接头 P09	直通变径接头 P10	直角接头 P11	三通接头 P12	三通变径接头 P13-14	四通接头 P15
00TKt 	90TKt 				
隔板直通接头 P16	隔板直角接头 P17				

组合连接

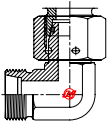
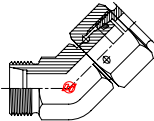
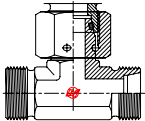
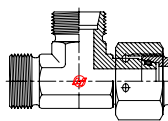
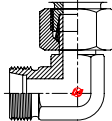
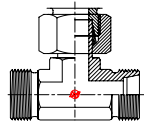
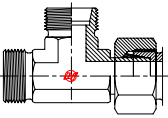
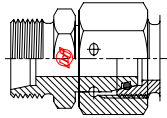
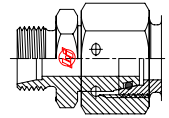
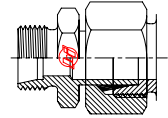
90TSr 	45TSr 	TTSr 	TSrT 	90TTs 	TTTs 
直角组合接头 P18	45°组合接头 P19	三通组合接头 P20	三通组合接头 P21	直角金属组合接头 P22	三通金属组合接头 P23
TTsT 	00TSr 	00TSr 	00TTs 		
三通金属组合接头 P24	直通过渡接头 P25	直通变径组合接头 P26-29	直通变径金属组合接头 P30-31		

布劳宁不承担因为印刷错误或样本其他错误而引起的责任；布劳宁可能在任何时候修改本样本中的尺寸或规范，届时无法事先告知每一位阅读本样本的客户！

目录

旋转螺母/旋转螺母连接

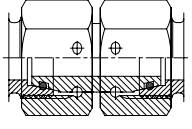
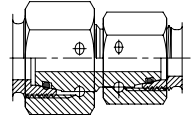
00SrSr 	00SrSr 
直通组合接头 P32	直通组合变径接头 P33-34

外螺纹油口连接

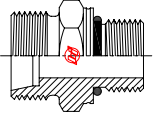
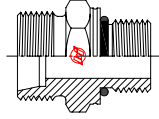
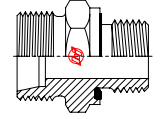
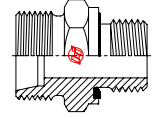
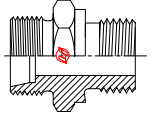
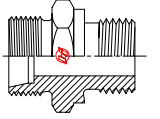
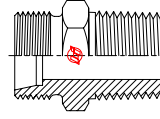
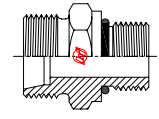
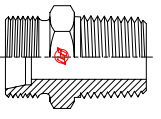
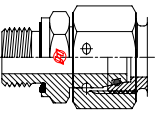
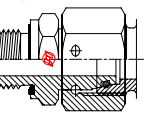
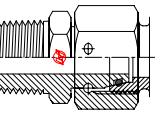
00TOm/00TON 	00TOt 	00TOe/00TOf 	00TOg/00TOh 	00TLm/00TLn 	00TLb/00TLc 
公制螺纹端直通接头 P35	英制螺纹端直通接头 P36	公制ED端直通接头 P37	英制ED端直通接头 P38-39	公制金属密封端直通接头 P40	英制金属密封端直通接头 P41-42
00TR 	00TOj/00TOd 	00TP 	00OeSr/00OfSr 	00OgSr/00OhSr 	00PSr 
BSPT端直通接头 P43	美制螺纹UNF端直通接头 P44	NPT端直通接头 P45-46	公制ED端直通组合 P47	英制ED端直通组合 P48	NPT端直通组合 P49

可调向接头

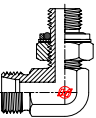
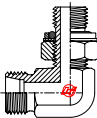
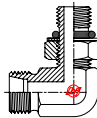
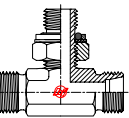
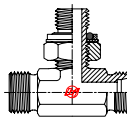
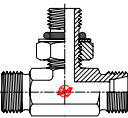
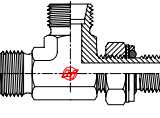
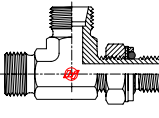
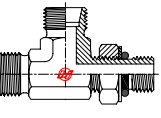
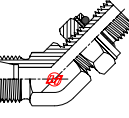
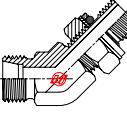
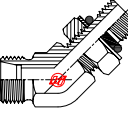
90TAs 	90TAb 	90TAj/90TAd 	TTAs 	TTAb 	TTAj/TTAd 
公制螺纹端直角可调向接头 P50	英制螺纹端直角可调向接头 P51	美制螺纹端直角可调向接头 P52	公制螺纹端三通可调向接头 P53	英制螺纹端三通可调向接头 P54	美制螺纹端三通可调向接头 P55
TAsT 	TAbT 	TAjT/TAdT 	45TAs 	45TAb 	45TAj/45TAd 
公制螺纹/直路端三通可调向接头 P56	英制螺纹/直路端三通可调向接头 P57	美制螺纹/直路端三通可调向接头 P58	公制螺纹45°可调向接头 P59	英制螺纹45°可调向接头 P60	美制螺纹45°可调向接头 P61

布劳宁不承担因为印刷错误或样本其他错误而引起的责任；布劳宁可能在任何时候修改本样本中的尺寸或规范，届时无法事先告知每一位阅读本样本的客户！

目录

铰接接头

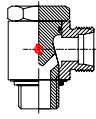
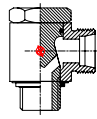
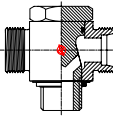
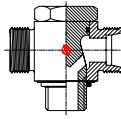
BJ-90TOe/BJ-90TOf	BJ-90TOg/BJ-90TOh	BJ-TTOg/BJ-TTOh	BJ-TTOe/BJ-TTOf
			
公制螺纹 90° 高压铰接式接头 P62	英制螺纹 90° 高压铰接式接头 P63	英制螺纹 三通 高压铰接式接头 P64	公制螺纹 三通 高压铰接式接头 P65

非调向接头

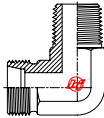
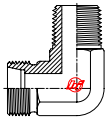
90TR	90TP
	
BSPT 非调向接头 P66	NPT 非调向接头 P67

内螺纹连接

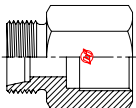
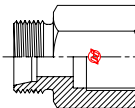
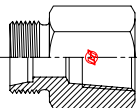
00TXm	00TXg	00TG
		
直通公制 内螺纹连接 P68	直通英制 内螺纹连接 P69	直通NPT 内螺纹连接 P70

油口变径接头

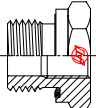
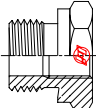
00OgXg	00LbXg
	
BSPP油口 变径ED密封接头 P71	BSPP油口 变径金属密封接头 P72

压力表接头

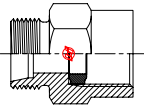
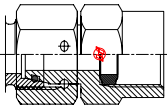
00THg	00SrHg
	
BSPP螺纹 压力表接头 P73	BSPP螺纹 压力表组合接头 P73

布劳宁不承担因为印刷错误或样本其他错误而引起的责任；布劳宁可能在任何时候修改本样本中的尺寸或规范，届时无法事先告知每一位阅读本样本的客户！

目录

堵头

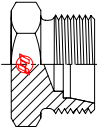
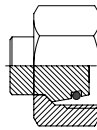
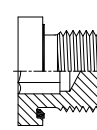
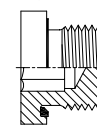
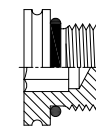
 <p>管端堵头 P74</p>	 <p>旋转螺母堵头 P75</p>	 <p>公制螺纹ED堵头 P76</p>	 <p>英制螺纹ED堵头 P76</p>	 <p>公制外螺纹堵头 P77</p>
--	--	--	--	---

焊接接头

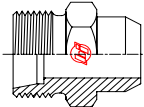
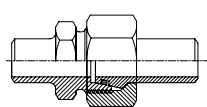
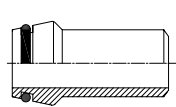
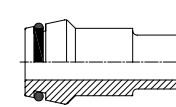
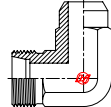
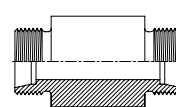
 <p>焊接接头 P78</p>	 <p>双头活接焊接接头 P79</p>	 <p>焊接直接头 P80</p>	 <p>变径焊接直接头 P81-82</p>	 <p>90°焊接接头 P83</p>	 <p>直通过板焊接直接头 P84</p>
--	--	---	---	---	---

法兰接头

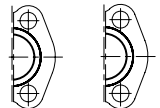
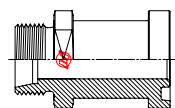
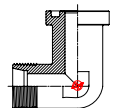
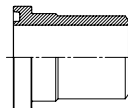
 <p>对开法兰片 P85</p>	 <p>法兰直接头 P86-87</p>	 <p>法兰90°弯头 P88-89</p>	 <p>焊接法兰直接头 P90-91</p>
---	--	--	--

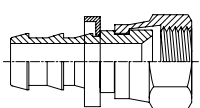
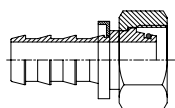

水/气软管接头

 <p>JIC37°扩口插入式软管接头 P92</p>	 <p>公制24°锥插入式软管接头 P92</p>
---	---

布劳宁不承担因为印刷错误或样本其他错误而引起的责任；布劳宁可能在任何时候修改本样本中的尺寸或规范，届时无法事先告知每一位阅读本样本的客户！

目录

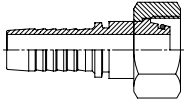
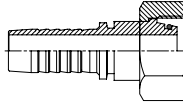
胶管接头

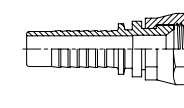
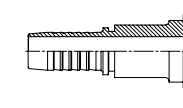
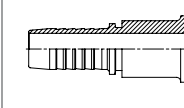
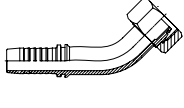
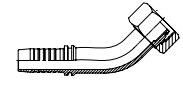
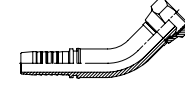
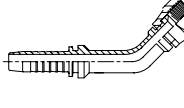
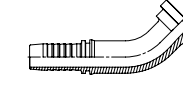
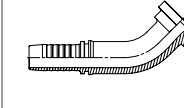
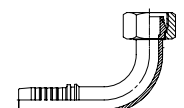
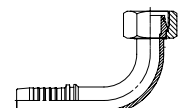
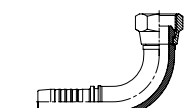
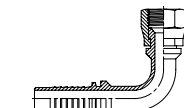
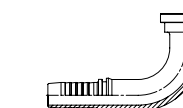
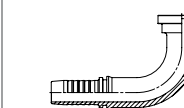
00R02Sr 	00R02Sr 	00R02Sb 	00R02Sj 	00R02Cj 	00R02Cd 
轻型 24° 锥直接头 P93	重型 24° 锥直接头 P94	BSPP 60° 锥直接头 P95	JIC 37° 锥直接头 P96	轻型 直接法兰接头 P97	重型 直接法兰接头 P98
45R02Sr 	45R02Sr 	45R02Sb 	45R02Sj 	45R02Cj 	45R02Cd 
轻型 24° 锥45°接头 P99	重型 24° 锥45°接头 P100	BSPP 60° 锥45°接头 P101	JIC 37° 锥45°接头 P102	轻型 45° 法兰接头 P103	重型 45° 法兰接头 P104
90R02Sr 	90R02Sr 	90R02Sb 	90R02Sj 	90R02Cj 	90R02Cd 
轻型 24° 锥90°接头 P105	重型 24° 锥90°接头 P106	BSPP 60° 锥90°接头 P107	JIC 37° 锥90°接头 P108	轻型 90° 法兰接头 P109	重型 90° 法兰接头 P110

套筒

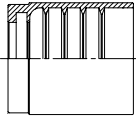
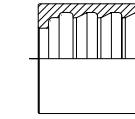
KR02 	KR04 
两层扣压式 软管套管 P111	四层扣压式 软管套管 P111

软管总成

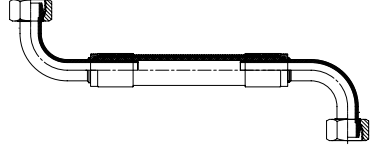
软管总成 P112

布劳宁不承担因为印刷错误或样本其他错误而引起的责任；布劳宁可能在任何时候修改本样本中的尺寸或规范，届时无法事先告知每一位阅读本样本的客户！

TNT 螺母

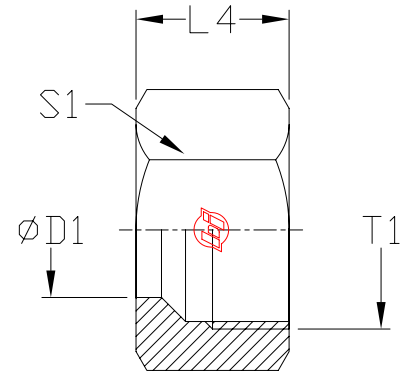

订货号	系列	钢管外径 D1	T1	L4	S1	PN (bar)	
						C	SS
TNT-LL04	LL	04	M 08x1.0	11.0	10	100	100
TNT-LL06		06	M 10x1.0	11.5	12	100	100
TNT-LL08		08	M 12x1.0	12.0	14	100	100
TNT-LL10		10	M 14x1.0	12.5	17.0	100	63
TNT-LL12		12	M 16x1.0	13.0	19.0	100	63
TNT-L06	L	06	M 12x1.5	14.5	14	500	315
TNT-L08		08	M 14x1.5	14.5	17	500	315
TNT-L10		10	M 16x1.5	15.5	19	500	315
TNT-L12		12	M 18x1.5	15.5	22	400	315
TNT-L15		15	M 22x1.5	17.0	27	400	315
TNT-L18		18	M 26x1.5	18.0	32	400	315
TNT-L22		22	M 30x2.0	20.0	36	250	160
TNT-L28		28	M 36x2.0	21.0	41	250	160
TNT-L35		35	M 45x2.0	24.0	50	250	160
TNT-L42		42	M 52x2.0	24.0	60	250	160
TNT-S06	S	6	M 14x1.5	16.5	17	800	630
TNT-S08		8	M 16x1.5	16.5	19	800	630
TNT-S10		10	M 18x1.5	17.5	22	800	630
TNT-S12		12	M 20x1.5	17.5	24	630	630
TNT-S14		14	M 22x1.5	20.5	27	630	630
TNT-S16		16	M 24x1.5	20.5	30	630	400
TNT-S20		20	M 30x2.0	24.0	36	420	400
TNT-S25		25	M 36x2.0	27.0	46	420	400
TNT-S30		30	M 42x2.0	29.0	50	420	400
TNT-S38		38	M 52x2.0	32.5	60	420	315

订货示例:

碳钢, 无六价铬镀锌: TNT-LL04

304不锈钢: TNT-LL04-304

316不锈钢: TNT-LL04-316

KO 卡套

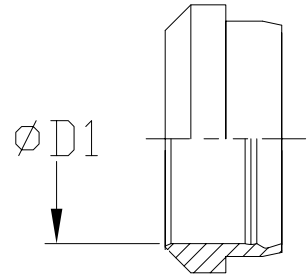

订货号	系列	钢管外径 D1	碳钢卡套 工作压力(bar)	不锈钢卡套 工作压力(bar)
KO-LL04	LL	04	100	63
KO-LL06		06	100	63
KO-LL08		08	100	63
KO-LL10		10	100	63
KO-LL12		12	100	63
KO-L06	L	06	500	315
KO-L08		08	500	315
KO-L10		10	500	315
KO-L12		12	400	315
KO-L15		15	400	315
KO-L18		18	400	315
KO-L22		22	250	160
KO-L28		28	250	160
KO-L35		35	250	160
KO-L42		42	250	160
KO-S06	S	06	800	630
KO-S08		08	800	630
KO-S10		10	800	630
KO-S12		12	630	630
KO-S14		14	630	630
KO-S16		16	630	400
KO-S20		20	420	400
KO-S25		25	420	400
KO-S30		30	420	400
KO-S38		38	420	315

订货示例:

碳钢, 无六价铬镀锌: KO-LL04

不锈钢: KO-LL04-316Ti

00TT 直通过头

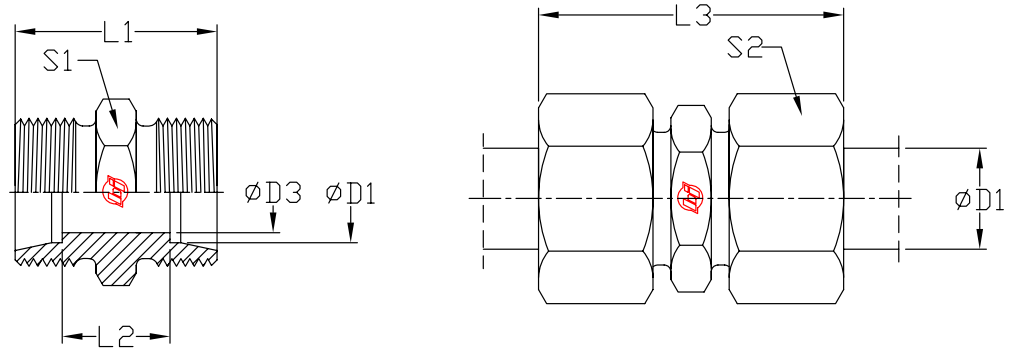

订货号	系列	钢管外径 D1	D3	L1	L2	L3	S1	S2	PN(bar)	
									C	SS
00TT-L06-L06	L	06	4.0	24.0	10.0	39.0	12	14	500	315
00TT-L08-L08		08	6.0	25.0	11.0	40.0	14	17	500	315
00TT-L10-L10		10	8.0	27.0	13.0	42.0	17	19	500	315
00TT-L12-L12		12	10.0	28.0	14.0	43.0	19	22	400	315
00TT-L15-L15		15	12.0	30.0	16.0	46.0	24	27	400	315
00TT-L18-L18		18	15.0	31.0	16.0	48.0	27	32	400	315
00TT-L22-L22		22	19.0	35.0	20.0	52.0	32	36	250	160
00TT-L28-L28		28	24.0	36.0	21.0	54.0	41	41	250	160
00TT-L35-L35		35	30.0	41.0	20.0	63.0	46	50	250	160
00TT-L42-L42		42	36.0	43.0	21.0	66.0	55	60	250	160
00TT-S06-S06	S	06	4.0	30.0	16.0	45.0	14	17	800	630
00TT-S08-S08		08	5.0	32.0	18.0	47.0	17	19	800	630
00TT-S10-S10		10	7.0	32.0	17.0	49.0	19	22	800	630
00TT-S12-S12		12	8.0	34.0	19.0	51.0	22	24	630	630
00TT-S14-S14		14	10.0	38.0	22.0	57.0	24	27	630	630
00TT-S16-S16		16	12.0	38.0	21.0	57.0	27	30	630	400
00TT-S20-S20		20	16.0	44.0	23.0	66.0	32	36	420	400
00TT-S25-S25		25	20.0	50.0	26.0	74.0	41	46	420	400
00TT-S30-S30		30	25.0	54.0	27.0	80.0	46	50	420	400
00TT-S38-S38		38	32.0	61.0	29.0	90.0	55	60	420	315

订货示例:

碳钢, 无六价铬镀锌: 00TT-L06-L06

304不锈钢: 00TT-L06-L06-304

316不锈钢: 00TT-L06-L06-316

注: 订货号不含螺母卡套

注: 订货号含螺母卡套 00TT-L06-L06-NBR

00TT 直通变径接头

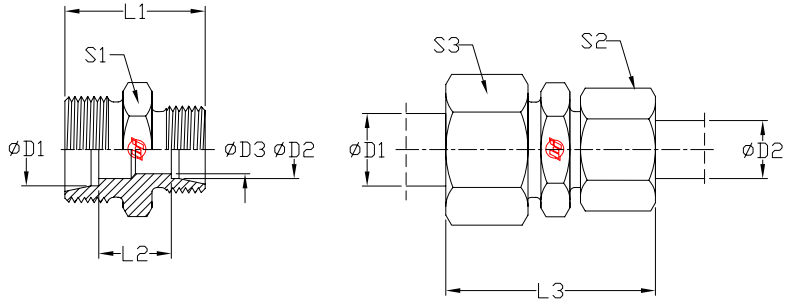

订货号	系列	钢管 外径 D1	钢管 外径 D2	D3	L1	L2	L3	S1	S2	S3	PN(bar)	
											C	SS
00TT-L08-L06	L	08	06	4.0	25.0	11.0	40.0	14	14	17	500	315
00TT-L10-L06		10	06	4.0	26.0	12.0	41.0	17	14	19	500	315
00TT-L10-L08		10	08	6.0	26.0	12.0	41.0	17	17	19	500	315
00TT-L12-L06		12	06	4.0	27.0	13.0	42.0	19	14	22	400	315
00TT-L12-L08		12	08	6.0	27.0	13.0	42.0	19	17	22	400	315
00TT-L12-L10		12	10	8.0	28.0	14.0	43.0	19	19	22	400	315
00TT-L15-L10		15	10	8.0	29.0	14.5	45.0	24	19	27	400	315
00TT-L15-L12		15	12	10.0	29.0	14.5	45.0	24	22	27	400	315
00TT-L18-L10		18	10	8.0	30.0	15.5	46.0	27	19	32	400	315
00TT-L18-L12		18	12	10.0	30.0	15.5	46.0	27	22	32	400	315
00TT-L18-L15		18	15	12.0	31.0	16.0	48.0	27	27	32	400	315
00TT-L22-L12		22	12	10.0	32.0	17.5	48.0	32	22	36	250	160
00TT-L22-L15		22	15	12.0	33.0	18.5	50.0	32	27	36	250	160
00TT-L22-L18		22	18	15.0	33.0	18.0	50.0	32	32	36	250	160
00TT-L28-L18		28	18	15.0	34.0	19.0	52.0	41	32	41	250	160
00TT-L28-L22		28	22	19.0	36.0	21.0	54.0	41	36	41	250	160
00TT-L35-L22		35	22	19.0	39.0	21.0	59.0	46	36	50	250	160
00TT-L35-L28		35	28	24.0	39.0	21.0	59.0	46	41	50	250	160
00TT-L42-L35	42	35	30.0	43.0	21.5	66.0	55	50	60	250	160	
00TT-S08-S06	S	08	06	4.0	32.0	18.0	47.0	17	17	19	800	630
00TT-S10-S06		10	06	4.0	32.0	17.5	48.0	19	17	22	800	630
00TT-S10-S08		10	08	5.0	32.0	17.5	48.0	19	19	22	800	630
00TT-S12-S06		12	06	4.0	34.0	19.5	50.0	22	17	24	630	630
00TT-S12-S08		12	08	5.0	34.0	19.5	50.0	22	19	24	630	630
00TT-S12-S10		12	10	7.0	34.0	19.0	51.0	22	22	24	630	630
00TT-S16-S10		16	10	7.0	36.0	20.0	54.0	27	22	30	630	400
00TT-S16-S12		16	12	8.0	36.0	20.0	54.0	27	24	30	630	400
00TT-S20-S10		20	10	7.0	40.0	22.0	60.0	32	22	36	420	400
00TT-S20-S12		20	12	8.0	40.0	22.0	60.0	32	24	36	420	400
00TT-S20-S16		20	16	12.0	42.0	23.0	63.0	32	30	36	420	400
00TT-S25-S16		25	16	12.0	46.0	25.5	68.0	41	30	46	420	400
00TT-S25-S20		25	20	16.0	48.0	25.5	71.0	41	36	46	420	400
00TT-S30-S20		30	20	16.0	50.0	26.0	74.0	46	36	50	420	400
00TT-S30-S25		30	25	20.0	52.0	26.5	77.0	46	46	50	420	400
00TT-S38-S30	38	30	25.0	59.0	29.5	87.0	55	50	60	420	315	

订货示例:

碳钢, 无六价铬镀锌: 00TT-L08-L06

304不锈钢: 00TT-L08-L06-304

316不锈钢: 00TT-L08-L06-316

注: 订货号不含螺母卡套

注: 订货号含螺母卡套 00TT-L08-L06-NBR

90TT 直角接头

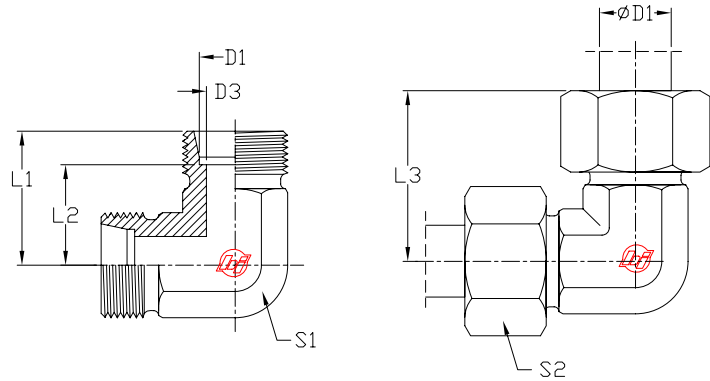

订货号	系列	钢管外径 D1	D3	L1	L2	L3	S1	S2	PN(bar)	
									C	SS
90TT-L06-L06	L	06	4.0	19.0	12.0	27.0	12	14	500	315
90TT-L08-L08		08	6.0	21.0	14.0	29.0	12	17	500	315
90TT-L10-L10		10	8.0	22.0	15.0	30.0	14	19	500	315
90TT-L12-L12		12	10.0	24.0	17.0	32.0	19	22	400	315
90TT-L15-L15		15	12.0	28.0	21.0	36.0	19	27	400	315
90TT-L18-L18		18	15.0	31.0	23.5	40.0	24	32	400	315
90TT-L22-L22		22	19.0	35.0	27.5	44.0	27	36	250	160
90TT-L28-L28		28	24.0	38.0	30.5	47.0	36	41	250	160
90TT-L35-L35		35	30.0	45.0	34.5	56.0	41	50	250	160
90TT-L42-L42		42	36.0	51.0	40.0	63.0	50	60	250	160
90TT-S06-S06	S	06	4.0	23.0	16.0	31.0	12	17	800	630
90TT-S08-S08		08	5.0	24.0	17.0	32.0	14	19	800	630
90TT-S10-S10		10	7.0	25.0	17.5	34.0	17	22	800	630
90TT-S12-S12		12	8.0	29.0	21.5	38.0	17	24	630	630
90TT-S14-S14		14	10.0	30.0	22.0	40.0	19	27	630	630
90TT-S16-S16		16	12.0	33.0	24.5	43.0	24	30	630	400
90TT-S20-S20		20	16.0	37.0	26.5	48.0	27	36	420	400
90TT-S25-S25		25	20.0	42.0	30.0	54.0	36	46	420	400
90TT-S30-S30		30	25.0	49.0	35.5	62.0	41	50	420	400
90TT-S38-S38		38	32.0	57.0	41.0	72.0	50	60	420	315

订货示例:

碳钢, 无六价铬镀锌: 90TT-L06-L06

304不锈钢: 90TT-L06-L06-304

316不锈钢: 90TT-L06-L06-316

注: 订货号不含螺母卡套

注: 订货号含螺母卡套 90TT-L06-L06-NBR

TTT 三通接头

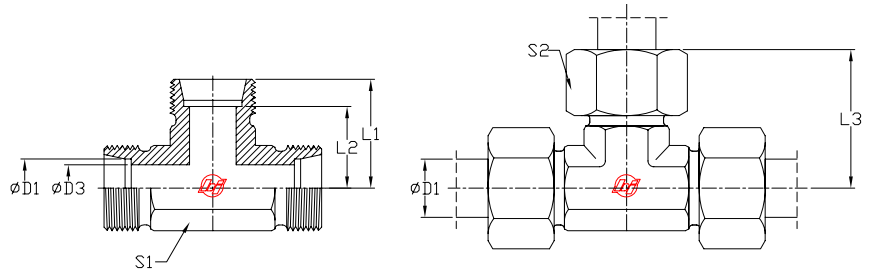

订货号	系列	钢管外径 D1	D3	L1	L2	L3	S1	S2	PN(bar)	
									C	SS
TTT-L06-L06-L06	L	06	4.0	19.0	12.0	27.0	12	14	500	315
TTT-L08-L08-L08		08	6.0	21.0	14.0	29.0	14	17	500	315
TTT-L10-L10-L10		10	8.0	22.0	15.0	30.0	14	19	500	315
TTT-L12-L12-L12		12	10	24.0	17.0	32.0	17	22	400	315
TTT-L15-L15-L15		15	12	28.0	21.0	36.0	19	27	400	315
TTT-L18-L18-L18		18	15	31.0	23.5	40.0	24	32	400	315
TTT-L22-L22-L22		22	19	35.0	27.5	44.0	27	36	250	160
TTT-L28-L28-L28		28	24	38.0	30.5	47.0	36	41	250	160
TTT-L35-L35-L35		35	30	45.0	34.5	56.0	41	50	250	160
TTT-L42-L42-L42		42	36	51.0	40.0	63.0	50	60	250	160
TTT-S06-S06-S06	S	06	4.0	23.0	16.0	31.0	12	17	800	630
TTT-S08-S08-S08		08	5.0	24.0	17.0	32.0	14	19	800	630
TTT-S10-S10-S10		10	7.0	25.0	17.5	34.0	17	22	800	630
TTT-S12-S12-S12		12	8.0	29.0	21.5	38.0	17	24	630	630
TTT-S14-S14-S14		14	10.0	30.0	22.0	40.0	19	27	630	630
TTT-S16-S16-S16		16	12	33.0	24.5	43.0	24	30	630	400
TTT-S20-S20-S20		20	16	37.0	26.5	48.0	27	36	420	400
TTT-S25-S25-S25		25	20	42.0	30.0	54.0	36	46	420	400
TTT-S30-S30-S30		30	25	49.0	35.5	62.0	41	50	420	400
TTT-S38-S38-S38		38	32	57.0	41.0	72.0	50	60	420	315

订货示例:

碳钢, 无六价铬镀锌: TTT-L06-L06-L06

304不锈钢: TTT-L06-L06-L06-304

316不锈钢: TTT-L06-L06-L06-316

注: 订货号不含螺母卡套

注: 订货号含螺母卡套 TTT-L06-L06-L06-NBR

TTT 三通变径接头

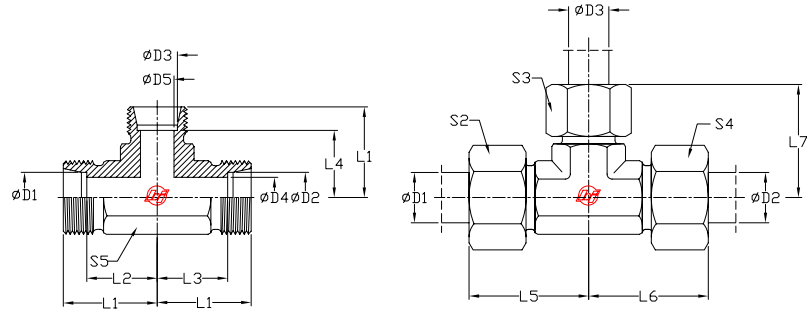

订货号	系列	钢管	钢管	钢管														PN(bar)	
		外径	外径	外径	D4	D5	L1	L2	L3	L4	L5	L6	L7	S2	S3	S4	S5	C	SS
		D1	D2	D3															
TTT-L06-L06-L08	L	06	06	08	4.0	6.0	21.0	14.0	14.0	14.0	29.0	29.0	29.0	14	17	14	14	500	315
TTT-L08-L08-L06		08	08	06	6.0	4.0	21.0	14.0	14.0	14.0	29.0	29.0	29.0	17	14	17	14	500	315
TTT-L06-L06-L10		06	06	10	4.0	8.0	22.0	15.0	15.0	15.0	30.0	30.0	30.0	14	19	14	14	500	315
TTT-L08-L08-L10		08	08	10	6.0	8.0	22.0	15.0	15.0	15.0	30.0	30.0	30.0	17	19	17	14	500	315
TTT-L10-L10-L06		10	10	06	8.0	4.0	22.0	15.0	15.0	15.0	30.0	30.0	30.0	19	14	19	14	500	315
TTT-L10-L10-L08		10	10	08	8.0	6.0	22.0	15.0	15.0	15.0	30.0	30.0	30.0	19	17	19	14	500	315
TTT-L10-L06-L10		10	06	10	4.0	8.0	22.0	15.0	15.0	15.0	30.0	30.0	30.0	19	19	14	14	500	315
TTT-L08-L08-L12		08	08	12	6.0	10.0	24.0	17.0	17.0	17.0	32.0	32.0	32.0	17	22	17	17	400	315
TTT-L12-L12-L06		12	12	06	10.0	4.0	24.0	17.0	17.0	17.0	32.0	32.0	32.0	22	14	22	17	400	315
TTT-L12-L08-L08		12	08	08	6.0	6.0	24.0	17.0	17.0	17.0	32.0	32.0	32.0	22	17	17	17	400	315
TTT-L12-L12-L08		12	12	08	10.0	6.0	24.0	17.0	17.0	17.0	32.0	32.0	32.0	22	17	22	17	400	315
TTT-L12-L10-L10		12	10	10	8.0	8.0	24.0	17.0	17.0	17.0	32.0	32.0	32.0	22	19	19	17	400	315
TTT-L12-L12-L10		12	12	10	10.0	8.0	24.0	17.0	17.0	17.0	32.0	32.0	32.0	22	19	22	17	400	315
TTT-L12-L10-L12		12	10	12	8.0	10.0	24.0	17.0	17.0	17.0	32.0	32.0	32.0	22	22	19	17	400	315
TTT-L10-L10-L15		10	10	15	8.0	12.0	28.0	21.0	21.0	21.0	36.0	36.0	36.0	19	27	19	19	400	315
TTT-L12-L12-L15		12	12	15	10.0	12.0	28.0	21.0	21.0	21.0	36.0	36.0	36.0	22	27	22	19	400	315
TTT-L15-L15-L06		15	15	06	12.0	4.0	28.0	21.0	21.0	21.0	36.0	36.0	36.0	27	14	27	19	400	315
TTT-L15-L15-L10		15	15	10	12.0	8.0	28.0	21.0	21.0	21.0	36.0	36.0	36.0	27	19	27	19	400	315
TTT-L15-L12-L12		15	12	12	10.0	10.0	28.0	21.0	21.0	21.0	36.0	36.0	36.0	27	22	22	19	400	315
TTT-L15-L15-L12		15	15	12	12.0	10.0	28.0	21.0	21.0	21.0	36.0	36.0	36.0	27	22	27	19	400	315
TTT-L15-L12-L15		15	12	15	10.0	12.0	28.0	21.0	21.0	21.0	36.0	36.0	36.0	27	27	22	19	400	315
TTT-L12-L12-L18		12	12	18	10.0	15.0	31.0	23.5	23.5	23.5	39.0	39.0	40.0	22	32	22	24	400	315
TTT-L18-L10-L10		18	10	10	8.0	8.0	31.0	23.5	23.5	23.5	40.0	39.0	39.0	32	19	19	24	400	315
TTT-L18-L18-L10		18	18	10	15.0	8.0	31.0	23.5	23.5	23.5	40.0	40.0	39.0	32	19	32	24	400	315
TTT-L18-L18-L12		18	18	12	15.0	10.0	31.0	23.5	23.5	23.5	40.0	40.0	39.0	32	22	32	24	400	315
TTT-L18-L18-L15		18	18	15	15.0	12.0	31.0	23.5	23.5	23.5	40.0	40.0	39.0	32	27	32	24	400	315
TTT-L18-L10-L18		18	10	18	8.0	15.0	31.0	23.5	23.5	23.5	40.0	39.0	40.0	32	32	19	24	400	315
TTT-L22-L22-L10		22	22	10	19.0	8.0	35.0	27.5	27.5	27.5	44.0	44.0	43.0	36	19	36	27	250	160
TTT-L22-L22-L12		22	22	12	19.0	10.0	35.0	27.5	27.5	27.5	44.0	44.0	43.0	36	22	36	27	250	160
TTT-L22-L15-L15		22	15	15	12.0	12.0	35.0	27.5	27.5	27.5	44.0	43.0	43.0	36	27	27	27	250	160

TTT 三通变径接头

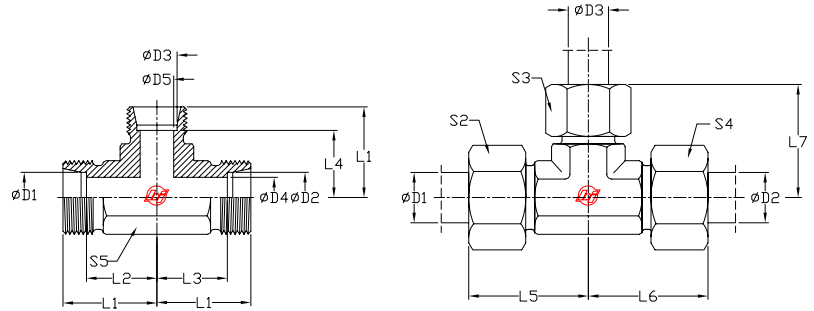

续上表

订货号	系列	钢管	钢管	钢管														PN(bar)	
		外径	外径	外径	D4	D5	L1	L2	L3	L4	L5	L6	L7	S2	S3	S4	S5	C	SS
TTT-L22-L22-L15	L	22	22	15	19.0	12.0	35.0	27.5	27.5	27.5	44.0	44.0	43.0	36	27	36	27	250	160
TTT-L22-L18-L18		22	18	18	15.0	15.0	35.0	27.5	27.5	27.5	44.0	44.0	44.0	36	32	32	27	250	160
TTT-L22-L22-L18		22	22	18	19.0	15.0	35.0	27.5	27.5	27.5	44.0	44.0	44.0	36	32	36	27	250	160
TTT-L22-L18-L22		22	18	22	15.0	19.0	35.0	27.5	27.5	27.5	44.0	44.0	44.0	36	36	32	27	250	160
TTT-L28-L28-L10		28	28	10	24.0	8.0	38.0	30.5	30.5	30.5	47.0	47.0	46.0	41	19	41	36	250	160
TTT-L28-L28-L12		28	28	12	24.0	10.0	38.0	30.5	30.5	30.5	47.0	47.0	46.0	41	22	41	36	250	160
TTT-L28-L28-L15		28	28	15	24.0	12.0	38.0	30.5	30.5	30.5	47.0	47.0	46.0	41	27	41	36	250	160
TTT-L28-L28-L18		28	28	18	24.0	15.0	38.0	30.5	30.5	30.5	47.0	47.0	47.0	41	32	41	36	250	160
TTT-L28-L22-L22		28	22	22	19.0	19.0	38.0	30.5	30.5	30.5	47.0	47.0	47.0	41	36	36	36	250	160
TTT-L28-L28-L22		28	28	22	24.0	19.0	38.0	30.5	30.5	30.5	47.0	47.0	47.0	41	36	41	36	250	160
TTT-S10-S10-S06		S	10	10	06	7.0	4.0	25.0	17.5	17.5	17.5	34.0	34.0	33.0	22	17	22	17	800
TTT-S12-S08-S08	12		08	08	5.0	5.0	29.0	21.5	21.5	21.5	38.0	37.0	37.0	24	19	19	17	630	630
TTT-S12-S12-S08	12		12	08	8.0	5.0	29.0	21.5	21.5	21.5	38.0	38.0	37.0	24	19	24	17	630	630
TTT-S12-S12-S10	12		12	10	8.0	7.0	29.0	21.5	21.5	21.5	38.0	38.0	38.0	24	22	24	17	630	630
TTT-S12-S12-S16	12		12	16	8.0	12.0	33.0	24.5	24.5	24.5	42.0	42.0	43.0	24	30	24	24	630	400
TTT-S16-S16-S06	16		16	06	12.0	4.0	33.0	24.5	24.5	24.5	43.0	43.0	41.0	30	17	30	24	630	400
TTT-S16-S16-S08	16		16	08	12.0	5.0	33.0	24.5	24.5	24.5	43.0	43.0	41.0	30	19	30	24	630	400
TTT-S16-S16-S10	16		16	10	12.0	7.0	33.0	24.5	24.5	24.5	43.0	43.0	42.0	30	22	30	24	630	400
TTT-S16-S16-S12	16		16	12	12.0	8.0	33.0	24.5	24.5	24.5	43.0	43.0	42.0	30	24	30	24	630	400
TTT-S16-S16-S20	16		16	20	12.0	16.0	37.0	26.5	26.5	26.5	47.0	47.0	48.0	30	36	30	27	420	400
TTT-S20-S20-S10	20		20	10	16.0	7.0	37.0	26.5	26.5	26.5	48.0	48.0	46.0	36	22	36	27	420	400
TTT-S20-S20-S12	20		20	12	16.0	8.0	37.0	26.5	26.5	26.5	48.0	48.0	46.0	36	24	36	27	420	400
TTT-S20-S20-S16	20		20	16	16.0	12.0	37.0	26.5	26.5	26.5	48.0	48.0	47.0	36	30	36	27	420	400
TTT-S20-S20-S25	20		20	25	16.0	20.0	42.0	30.0	30.0	30.0	53.0	53.0	54.0	36	46	36	36	420	400
TTT-S25-S25-S16	25		25	16	20.0	12.0	42.0	30.0	30.0	30.0	54.0	54.0	52.0	46	30	46	36	420	400
TTT-S25-S25-S20	25		25	20	20.0	16.0	42.0	30.0	30.0	30.0	54.0	54.0	53.0	46	36	46	36	420	400
TTT-S25-S25-S30	25		25	30	20.0	25.0	49.0	35.5	35.5	35.5	61.0	6.01	62.0	46	50	46	41	420	400

订货示例:

碳钢, 无六价铬镀锌: TTT-L06-L06-L08

304不锈钢: TTT-L06-L06-L08-304

316不锈钢: TTT-L06-L06-L08-316

注: 订货号含螺母卡套 TTT-L06-L06-L08-NBR

TTTT 四通接头

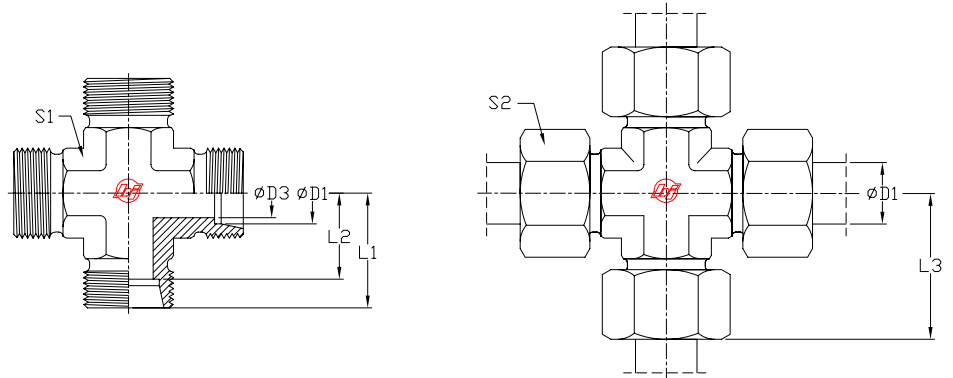

订货号	系列	钢管外径		L1	L2	L3	S1	S2	PN(bar)	
		D1	D3						C	SS
TTTT-L06-L06-L06-L06	L	06	4.0	19.0	12.0	27.0	12	14	315	315
TTTT-L08-L08-L08-L08		08	6.0	21.0	14.0	29.0	14	17	315	315
TTTT-L10-L10-L10-L10		10	8.0	22.0	15.0	30.0	14	19	315	315
TTTT-L12-L12-L12-L12		12	10.0	24.0	17.0	32.0	17	22	315	315
TTTT-L15-L15-L15-L15		15	12.0	28.0	21.0	36.0	19	27	315	315
TTTT-L18-L18-L18-L18		18	15.0	31.0	23.5	40.0	24	32	315	315
TTTT-L22-L22-L22-L22		22	19.0	35.0	27.5	44.0	27	36	160	160
TTTT-L28-L28-L28-L28		28	24.0	38.0	30.5	47.0	36	41	160	160
TTTT-L35-L35-L35-L35		35	30.0	45.0	34.5	56.0	41	50	160	160
TTTT-L42-L42-L42-L42		42	36.0	51.0	40.0	63.0	50	60	160	160
TTTT-S06-S06-S06-S06	S	06	4.0	23.0	16.0	31.0	14	17	630	630
TTTT-S08-S08-S08-S08		08	5.0	24.0	17.0	32.0	14	19	630	630
TTTT-S10-S10-S10-S10		10	7.0	25.0	17.5	34.0	17	22	630	630
TTTT-S12-S12-S12-S12		12	8.0	29.0	21.5	38.0	17	24	630	630
TTTT-S14-S14-S14-S14		14	10.0	30.0	22.0	40.0	19	27	400	400
TTTT-S16-S16-S16-S16		16	12.0	33.0	24.5	43.0	24	30	400	400
TTTT-S20-S20-S20-S20		20	16.0	37.0	26.5	48.0	30	36	315	315
TTTT-S25-S25-S25-S25		25	20.0	42.0	30.0	54.0	36	46	315	315
TTTT-S30-S30-S30-S30		30	25.0	49.0	35.5	62.0	41	50	315	315
TTTT-S38-S38-S38-S38		38	32.0	57.0	41.0	72.0	50	60	315	315

订货示例:

碳钢, 无六价铬镀锌: TTTT-L06-L06-L06-L06

304不锈钢: TTTT-L06-L06-L06-L06-304

316不锈钢: TTTT-L06-L06-L06-L06-316

注: 订货号不含螺母卡套

注: 订货号含螺母卡套 TTTT-L06-L06-L06-L06-NBR

00TKt 隔板直通接头

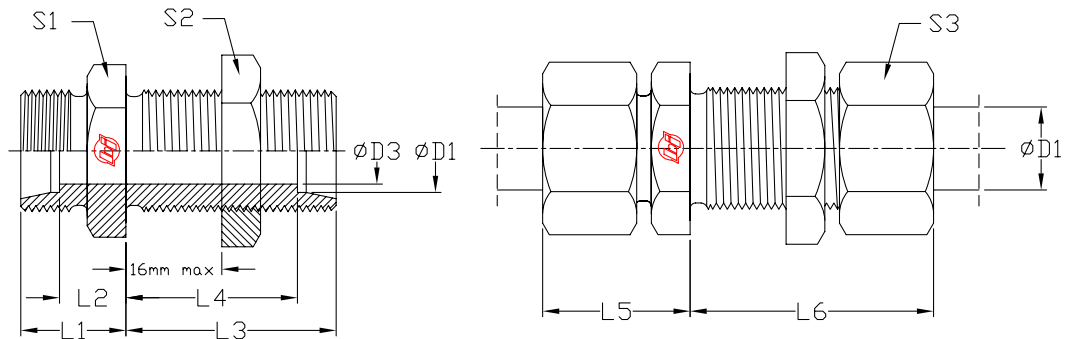

订货号	系列	钢管 外径											PN(bar)	
		D1	D3	L1	L2	L3	L4	L5	L6	S1	S2	S3	C	SS
00TKt-L06-L06-LN	L	06	4.0	14.0	7.0	34.0	27.0	22.0	42.0	17	17	14	500	315
00TKt-L08-L08-LN		08	6.0	15.0	8.0	34.0	27.0	23.0	42.0	19	19	17	500	315
00TKt-L10-L10-LN		10	8.0	17.0	10.0	35.0	28.0	25.0	43.0	22	22	19	500	315
00TKt-L12-L12-LN		12	10.0	17.0	10.0	36.0	29.0	25.0	44.0	24	24	22	400	315
00TKt-L15-L15-LN		15	12.0	19.0	12.0	38.0	31.0	27.0	46.0	27	30	27	400	315
00TKt-L18-L18-LN		18	15.0	21.0	13.5	40.0	32.5	30.0	49.0	32	36	32	400	315
00TKt-L22-L22-LN		22	19.0	24.0	16.5	42.0	34.5	33.0	51.0	36	41	36	250	160
00TKt-L28-L28-LN		28	24.0	26.0	18.5	43.0	35.5	35.0	52.0	41	46	41	250	160
00TKt-L35-L35-LN		35	30.0	29.0	18.5	47.0	36.5	40.0	58.0	50	55	50	250	160
00TKt-L42-L42-LN		42	36.0	30.0	19.0	47.0	36.0	42.0	59.0	60	65	60	250	160
00TKt-S06-S06-LN	S	06	4.0	19.0	12.0	36.0	29.0	27.0	44.0	19	19	17	800	630
00TKt-S08-S08-LN		08	5.0	20.0	13.0	36.0	29.0	28.0	44.0	22	22	19	800	630
00TKt-S10-S10-LN		10	7.0	22.0	14.5	37.0	29.5	31.0	46.0	24	24	22	800	630
00TKt-S12-S12-LN		12	8.0	22.0	14.5	38.0	30.5	31.0	47.0	27	27	24	630	630
00TKt-S14-S14-LN		14	10.0	25.0	17.0	40.0	32.0	35.0	50.0	30	30	27	630	630
00TKt-S16-S16-LN		16	12.0	25.0	16.5	40.0	31.5	35.0	50.0	32	32	30	630	400
00TKt-S20-S20-LN		20	16.0	28.0	17.5	44.0	33.5	39.0	55.0	41	41	36	420	400
00TKt-S25-S25-LN		25	20.0	32.0	20.0	47.0	35.0	44.0	59.0	46	46	46	420	400
00TKt-S30-S30-LN		30	25.0	35.0	21.5	51.0	37.5	48.0	64.0	50	50	50	420	400
00TKt-S38-S38-LN		38	32.0	38.0	22.0	53.0	37.0	53.0	68.0	65	65	60	420	315

订货示例:

碳钢, 无六价铬镀锌: 00TKt-L06-L06-LN

304不锈钢: 00TKt-L06-L06-LN-304

316不锈钢: 00TKt-L06-L06-LN-316

注: 订货号不含螺母卡套

注: 订货号含螺母卡套 00TKt-L06-L06-LN-NBR

90TKt 隔板直角接头

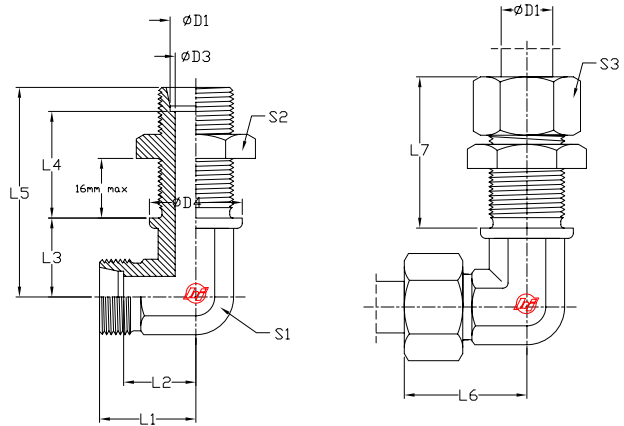

订货号	系列	钢管 外径		D4	L1	L2	L3	L4	L5	L6	L7	S1	S2	S3	PN(bar)	
		D1	D3												C	SS
90TKt-L06-L06-LN	L	06	4.0	17.0	19.0	12.0	14.0	27.0	48.0	27.0	42.0	12	17	14	315	315
90TKt-L08-L08-LN		08	6.0	19.0	21.0	14.0	17.0	27.0	51.0	29.0	42.0	12	19	17	315	315
90TKt-L10-L10-LN		10	8.0	22.0	22.0	15.0	18.0	28.0	53.0	30.0	43.0	14	22	19	315	315
90TKt-L12-L12-LN		12	10.0	24.0	24.0	17.0	20.0	29.0	56.0	32.0	44.0	17	24	22	315	315
90TKt-L15-L15-LN		15	12.0	27.0	28.0	21.0	23.0	31.0	61.0	36.0	46.0	19	30	27	315	315
90TKt-L18-L18-LN		18	15.0	32.0	31.0	23.5	24.0	32.5	64.0	40.0	49.0	24	36	32	315	315
90TKt-L22-L22-LN		22	19.0	36.0	35.0	27.5	30.0	34.5	72.0	44.0	51.0	27	41	36	160	160
90TKt-L28-L28-LN		28	24.0	42.0	38.0	30.5	34.0	35.5	77.0	47.0	52.0	36	46	41	160	160
90TKt-L35-L35-LN		35	30.0	50.0	45.0	34.5	39.0	36.5	86.0	56.0	58.0	41	55	50	160	160
90TKt-L42-L42-LN		42	36.0	60.0	51.0	40.0	43.0	36.0	90.0	63.0	59.0	50	65	60	160	160
90TKt-S06-S06-LN	S	06	4.0	19.0	23.0	16.0	17.0	29.0	53.0	31.0	44.0	12	19	17	630	630
90TKt-S08-S08-LN		08	5.0	22.0	24.0	17.0	18.0	29.0	54.0	32.0	44.0	14	22	19	630	630
90TKt-S10-S10-LN		10	7.0	24.0	25.0	17.5	20.0	29.5	57.0	34.0	46.0	17	24	22	630	630
90TKt-S12-S12-LN		12	8.0	27.0	29.0	21.5	21.0	30.5	59.0	38.0	47.0	17	27	24	630	630
90TKt-S14-S14-LN		14	10.0	27.0	30.0	22.0	23.0	32.0	63.0	40.0	50.0	19	30	27	630	630
90TKt-S16-S16-LN		16	12.0	30.0	33.0	24.5	24.0	31.5	64.0	43.0	50.0	24	32	30	400	400
90TKt-S20-S20-LN		20	16.0	36.0	37.0	26.5	30.0	33.5	74.0	48.0	55.0	27	41	36	400	400
90TKt-S25-S25-LN		25	20.0	42.0	42.0	30.0	34.0	35.0	81.0	54.0	59.0	36	46	46	400	400
90TKt-S30-S30-LN		30	25.0	50.0	49.0	35.5	39.0	37.5	90.0	62.0	64.0	41	50	50	400	400
90TKt-S38-S38-LN		38	32.0	60.0	57.0	41.0	43.0	37.0	96.0	72.0	68.0	50	65	60	315	315

订货示例:

碳钢, 无六价铬镀锌: 90TKt-L06-L06-LN

304不锈钢: 90TKt-L06-L06-LN-304

316不锈钢: 90TKt-L06-L06-LN-316

注: 订货号不含螺母卡套

注: 订货号含螺母卡套 90TKt-L06-L06-LN-NBR

90TSr 直角组合接头

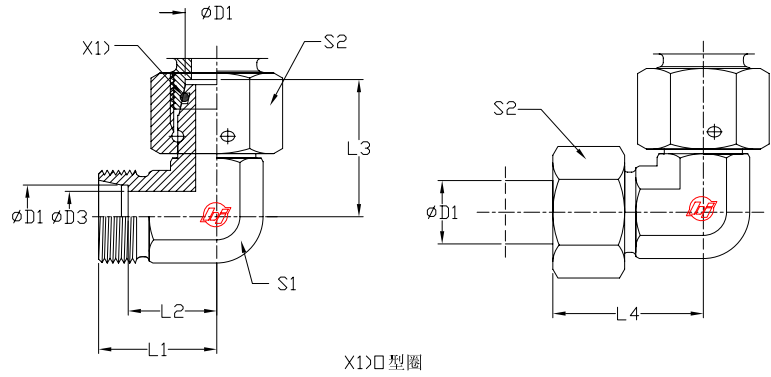

订货号	系列	钢管 外径		L1	L2	L3	L4	S1	S2	PN(bar)	
		D1	D3							C	SS
90TSr-L06-L06	L	06	4.0	19.0	12.0	26.0	27.0	12	14	500	315
90TSr-L08-L08		08	6.0	21.0	14.0	27.5	29.0	12	17	500	315
90TSr-L10-L10		10	8.0	22.0	15.0	29.0	30.0	14	19	500	315
90TSr-L12-L12		12	10.0	24.0	17.0	29.5	32.0	17	22	400	315
90TSr-L15-L15		15	12.0	28.0	21.0	32.5	36.0	19	27	400	315
90TSr-L18-L18		18	15.0	31.0	23.5	35.5	40.0	24	32	400	315
90TSr-L22-L22		22	19.0	35.0	27.5	38.5	44.0	27	36	250	160
90TSr-L28-L28		28	24.0	38.0	30.5	41.5	47.0	36	41	250	160
90TSr-L35-L35		35	30.0	45.0	34.5	51.0	56.0	41	50	250	160
90TSr-L42-L42		42	36.0	51.0	40.0	56.0	63.0	50	60	250	160
90TSr-S06-S06	S	06	4.0	23.0	16.0	27.0	31.0	12	17	800	630
90TSr-S08-S08		08	5.0	24.0	17.0	27.5	32.0	14	19	800	630
90TSr-S10-S10		10	6.0	25.0	17.5	30.0	34.0	17	22	800	630
90TSr-S12-S12		12	8.0	29.0	21.5	31.0	38.0	17	24	630	630
90TSr-S16-S16		16	12.0	33.0	24.5	36.5	43.0	24	30	630	400
90TSr-S20-S20		20	16.0	37.0	26.5	44.5	48.0	27	36	420	400
90TSr-S25-S25		25	20.0	42.0	30.0	50.0	54.0	36	46	420	400
90TSr-S30-S30		30	25.0	49.0	35.5	55.0	62.0	41	50	420	400
90TSr-S38-S38		38	32.0	57.0	41.0	63.0	72.0	50	60	420	315

订货示例:

碳钢, 无六价铬镀锌: 90TSr-L06-L06

304不锈钢: 90TSr-L06-L06-304

316不锈钢: 90TSr-L06-L06-316

注: 订货号不含螺母卡套

注: 订货号含螺母卡套 90TSr-L06-L06-NBR

45TSr 45°组合接头

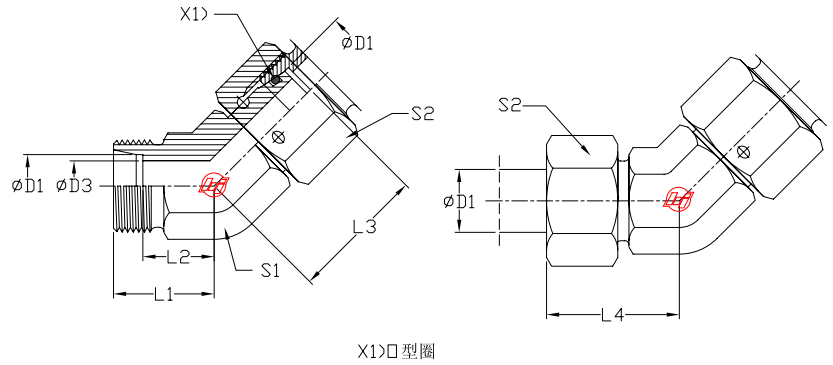

订货号	系列	钢管外径		L1	L2	L3	L4	S1	S2	PN(bar)	
		D1	D3							C	SS
45TSr-L06-L06	L	06	4.0	16.0	9.0	26.0	24.0	14	14	315	315
45TSr-L08-L08		08	6.0	19.0	12.0	27.5	27.0	14	17	315	315
45TSr-L10-L10		10	8.0	19.0	12.0	29.0	27.0	19	19	315	315
45TSr-L12-L12		12	10.0	21.0	14.0	29.5	29.0	19	22	315	315
45TSr-L15-L15		15	12.0	24.0	17.0	32.5	32.0	22	27	315	315
45TSr-L18-L18		18	15.0	24.0	16.5	35.5	33.0	27	32	315	315
45TSr-L22-L22		22	19.0	26.0	18.5	38.5	35.0	30	36	160	160
45TSr-L28-L28		28	24.0	30.5	23.0	41.5	40.0	36	41	160	160
45TSr-L35-L35		35	30.0	37.0	26.5	51.0	48.0	41	50	160	160
45TSr-L42-L42		42	36.0	37.0	26.0	56.0	49.0	50	60	160	160
45TSr-S06-S06	S	06	4.0	16.0	9.0	27.0	24.0	14	17	630	630
45TSr-S08-S08		08	5.0	19.0	12.0	27.5	27.0	19	19	630	630
45TSr-S10-S10		10	7.0	21.0	13.5	30.0	30.0	19	22	630	630
45TSr-S12-S12		12	8.0	24.0	16.5	31.0	33.0	22	24	630	630
45TSr-S16-S16		16	12.0	24.0	15.5	36.5	34.0	27	30	400	400
45TSr-S20-S20		20	16.0	26.5	16.0	44.5	38.0	30	36	400	400
45TSr-S25-S25		25	20.0	30.5	18.5	50.0	43.0	36	46	400	400
45TSr-S30-S30		30	25.0	37.0	23.5	55.0	50.0	41	50	400	400
45TSr-S38-S38		38	32.0	37.0	21.0	63.0	52.0	50	60	315	315

订货示例:

碳钢, 无六价铬镀锌: 45TSr-L06-L06

304不锈钢: 45TSr-L06-L06-304

316不锈钢: 45TSr-L06-L06-316

注: 订货号不含螺母卡套

注: 订货号含螺母卡套 45TSr-L06-L06-NBR

TTSr 三通组合接头

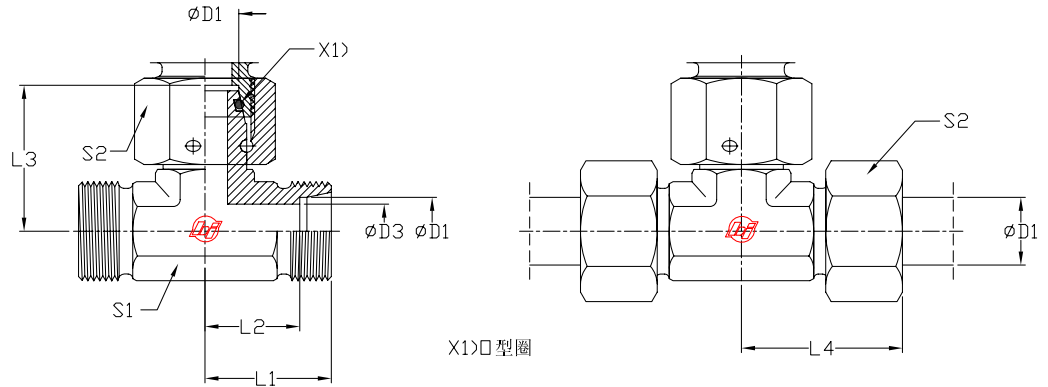

订货号	系列	钢管 外径									PN(bar)	
		D1	D3	L1	L2	L3	L4	S1	S2	C	SS	
TTSr-L06-L06-L06	L	06	4.0	19.0	12.0	26.0	27.0	12	14	500	315	
TTSr-L08-L08-L08		08	6.0	21.0	14.0	27.5	29.0	12	17	500	315	
TTSr-L10-L10-L10		10	8.0	22.0	15.0	29.0	30.0	14	19	500	315	
TTSr-L12-L12-L12		12	10.0	24.0	17.0	29.5	32.0	17	22	400	315	
TTSr-L15-L15-L15		15	12.0	28.0	21.0	32.5	36.0	19	27	400	315	
TTSr-L18-L18-L18		18	15.0	31.0	23.5	35.5	40.0	24	32	400	315	
TTSr-L22-L22-L22		22	19.0	35.0	27.5	38.5	44.0	27	36	250	160	
TTSr-L28-L28-L28		28	24.0	38.0	30.5	41.5	47.0	36	41	250	160	
TTSr-L35-L35-L35		35	30.0	45.0	34.5	51.0	56.0	41	50	250	160	
TTSr-L42-L42-L42		42	36.0	51.0	40.0	56.0	63.0	50	60	250	160	
TTSr-S06-S06-S06	S	06	4.0	23.0	16.0	27.0	31.0	12	17	800	630	
TTSr-S08-S08-S08		08	5.0	24.0	17.0	27.5	32.0	14	19	800	630	
TTSr-S10-S10-S10		10	7.0	25.0	17.5	30.0	34.0	17	22	800	630	
TTSr-S12-S12-S12		12	8.0	29.0	21.5	31.0	38.0	17	24	630	630	
TTSr-S14-S14-S14		14	9.0	30.0	22.0	35.0	40.0	19	27	630	630	
TTSr-S16-S16-S16		16	12.0	33.0	24.5	36.5	43.0	24	30	630	400	
TTSr-S20-S20-S20		20	16.0	37.0	26.5	44.5	48.0	27	36	420	400	
TTSr-S25-S25-S25		25	20.0	42.0	30.0	50.0	54.0	36	46	420	400	
TTSr-S30-S30-S30		30	25.0	49.0	35.5	55.0	62.0	41	50	420	400	
TTSr-S38-S38-S38		38	32.0	57.0	41.0	63.0	72.0	50	60	420	315	

订货示例:

碳钢, 无六价铬镀锌: TTSr-L06-L06-L06

304不锈钢: TTSr-L06-L06-L06-304

316不锈钢: TTSr-L06-L06-L06-316

注: 订货号不含螺母卡套

注: 订货号含螺母卡套 TTSr-L06-L06-L06-NBR

TSrT 三通组合接头

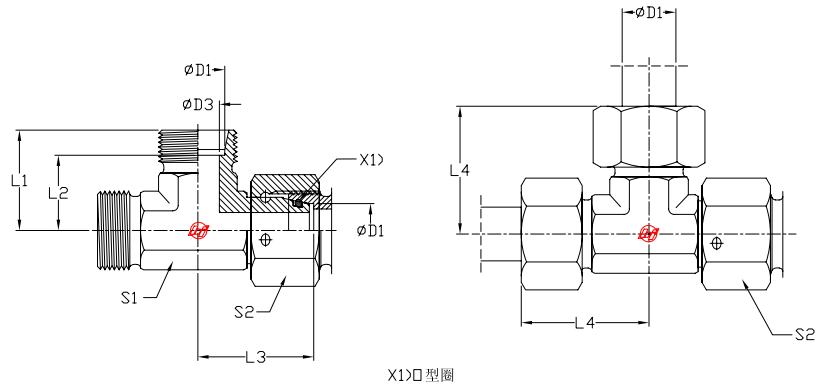

订货号	系列	钢管 外径	D3	L1	L2	L3	L4	S1	S2	PN(bar)	
		D1								C	SS
TSrT-L06-L06-L06	L	06	4.0	19.0	12.0	26.0	27.0	12	14	500	315
TSrT-L08-L08-L08		08	6.0	21.0	14.0	27.5	29.0	12	17	500	315
TSrT-L10-L10-L10		10	8.0	22.0	15.0	29.0	30.0	14	19	500	315
TSrT-L12-L12-L12		12	10.0	24.0	17.0	29.5	32.0	17	22	400	315
TSrT-L15-L15-L15		15	12.0	28.0	21.0	32.5	36.0	19	27	400	315
TSrT-L18-L18-L18		18	15.0	31.0	23.5	35.5	40.0	24	32	400	315
TSrT-L22-L22-L22		22	19.0	35.0	27.5	38.5	44.0	27	36	250	160
TSrT-L28-L28-L28		28	24.0	38.0	30.5	41.5	47.0	36	41	250	160
TSrT-L35-L35-L35		35	30.0	45.0	34.5	51.0	56.0	41	50	250	160
TSrT-L42-L42-L42		42	36.0	51.0	40.0	56.0	63.0	50	60	250	160
TSrT-S06-S06-S06	S	06	4.0	23.0	16.0	27.0	31.0	12	17	800	630
TSrT-S08-S08-S08		08	5.0	24.0	17.0	27.5	32.0	14	19	800	630
TSrT-S10-S10-S10		10	7.0	25.0	17.5	30.0	34.0	17	22	800	630
TSrT-S12-S12-S12		12	8.0	29.0	21.5	31.0	38.0	17	24	630	630
TSrT-S14-S14-S14		14	9.0	30.0	22.0	35.0	40.0	19	27	630	630
TSrT-S16-S16-S16		16	12.0	33.0	24.5	36.5	43.0	24	30	630	400
TSrT-S20-S20-S20		20	16.0	37.0	26.5	44.5	48.0	27	36	420	400
TSrT-S25-S25-S25		25	20.0	42.0	30.0	50.0	54.0	36	46	420	400
TSrT-S30-S30-S30		30	25.0	49.0	35.5	55.0	62.0	41	50	420	400
TSrT-S38-S38-S38		38	32.0	57.0	41.0	63.0	72.0	50	60	420	315

订货示例:

碳钢, 无六价铬镀锌: TSrT-L06-L06-L06

304不锈钢: TSrT-L06-L06-L06-304

316不锈钢: TSrT-L06-L06-L06-316

注: 订货号不含螺母卡套

注: 订货号含螺母卡套 TSrT-L06-L06-L06-NBR

90TTs 直角金属组合接头

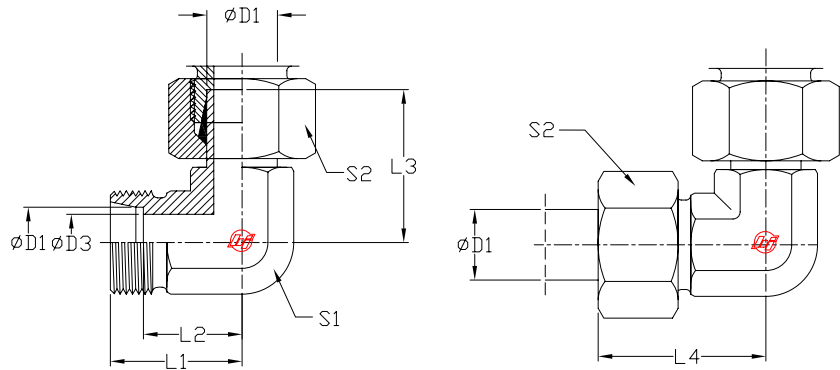

订货号	系列	钢管 外径		L1	L2	L3	L4	S1	S2	PN(bar)	
		D1	D3							C	SS
90TTs-L06-L06	L	06	4.0	19.0	12.0	26.0	27.0	12	14	315	315
90TTs-L08-L08		08	6.0	21.0	14.0	27.5	29.0	12	17	315	315
90TTs-L10-L10		10	8.0	22.0	15.0	29.0	30.0	14	19	315	315
90TTs-L12-L12		12	10.0	24.0	17.0	29.5	32.0	17	22	315	315
90TTs-L15-L15		15	12.0	28.0	21.0	32.5	36.0	19	27	315	315
90TTs-L18-L18		18	15.0	31.0	23.5	35.5	40.0	24	32	315	315
90TTs-L22-L22		22	19.0	35.0	27.5	38.5	44.0	27	36	160	160
90TTs-L28-L28		28	24.0	38.0	30.5	41.5	47.0	36	41	160	160
90TTs-L35-L35		35	30.0	45.0	34.5	51.0	56.0	41	50	160	160
90TTs-L42-L42		42	36.0	51.0	40.0	56.0	63.0	50	60	160	160
90TTs-S06-S06	S	06	4.0	23.0	16.0	27.0	31.0	12	17	630	630
90TTs-S08-S08		08	5.0	24.0	17.0	27.5	32.0	14	19	630	630
90TTs-S10-S10		10	7.0	25.0	17.5	30.0	34.0	17	22	630	630
90TTs-S12-S12		12	8.0	29.0	21.5	31.0	38.0	17	24	630	630
90TTs-S14-S14		14	10.0	30.0	22.0	35.0	40.0	19	27	400	400
90TTs-S16-S16		16	12.0	33.0	24.5	36.5	43.0	24	30	400	400
90TTs-S20-S20		20	16.0	37.0	26.5	44.5	48.0	27	36	400	400
90TTs-S25-S25		25	20.0	42.0	30.0	50.0	54.0	36	46	400	400
90TTs-S30-S30		30	25.0	49.0	35.5	55.0	62.0	41	50	400	400
90TTs-S38-S38		38	32.0	57.0	41.0	63.0	72.0	50	60	315	315

订货示例:

碳钢, 无六价铬镀锌: 90TTs-L06-L06

304不锈钢: 90TTs-L06-L06-304

316不锈钢: 90TTs-L06-L06-316

注: 订货号不含螺母卡套

注: 订货号含螺母卡套 90TTs-L06-L06-NBR

TTTs 三通金属组合接头

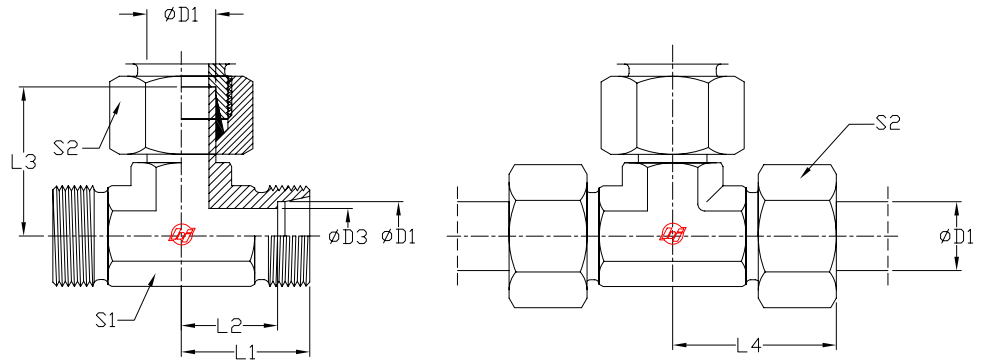

订货号	系列	钢管 外径	D3	L1	L2	L3	L4	S1	S2	PN(bar)	
		D1								C	SS
TTTs-L06-L06-L06	L	06	4.0	19.0	12.0	26.0	27.0	12	14	315	315
TTTs-L08-L08-L08		08	6.0	21.0	14.0	27.5	29.0	12	17	315	315
TTTs-L10-L10-L10		10	8.0	22.0	15.0	29.0	30.0	14	19	315	315
TTTs-L12-L12-L12		12	10.0	24.0	17.0	29.5	32.0	17	22	315	315
TTTs-L15-L15-L15		15	12.0	28.0	21.0	32.5	36.0	19	27	315	315
TTTs-L18-L18-L18		18	15.0	31.0	23.5	35.5	40.0	24	32	315	315
TTTs-L22-L22-L22		22	19.0	35.0	27.5	38.5	44.0	27	36	160	160
TTTs-L28-L28-L28		28	24.0	38.0	30.5	41.5	47.0	36	41	160	160
TTTs-L35-L35-L35		35	30.0	45.0	34.5	51.0	56.0	41	50	160	160
TTTs-L42-L42-L42		42	36.0	51.0	40.0	56.0	63.0	50	60	160	160
TTTs-S06-S06-S06	S	06	4.0	23.0	16.0	27.0	31.0	12	17	630	630
TTTs-S08-S08-S08		08	5.0	24.0	17.0	27.5	32.0	14	19	630	630
TTTs-S10-S10-S10		10	7.0	25.0	17.5	30.0	34.0	17	22	630	630
TTTs-S12-S12-S12		12	8.0	29.0	21.5	31.0	38.0	17	24	630	630
TTTs-S14-S14-S14		14	10.0	30.0	22.0	35.0	40.0	19	27	400	400
TTTs-S16-S16-S16		16	12.0	33.0	24.5	36.5	43.0	24	30	400	400
TTTs-S20-S20-S20		20	16.0	37.0	26.5	44.5	48.0	27	36	400	400
TTTs-S25-S25-S25		25	20.0	42.0	30.0	50.0	54.0	36	46	400	400
TTTs-S30-S30-S30		30	25.0	49.0	35.5	55.0	62.0	41	50	400	400
TTTs-S38-S38-S38		38	32.0	57.0	41.0	63.0	72.0	50	60	315	315

订货示例:

碳钢, 无六价铬镀锌: TTTs-L06-L06-L06

304不锈钢: TTTs-L06-L06-L06-304

316不锈钢: TTTs-L06-L06-L06-316

注: 订货号不含螺母卡套

注: 订货号含螺母卡套 TTTs-L06-L06-L06-NBR

TTsT 三通金属组合接头

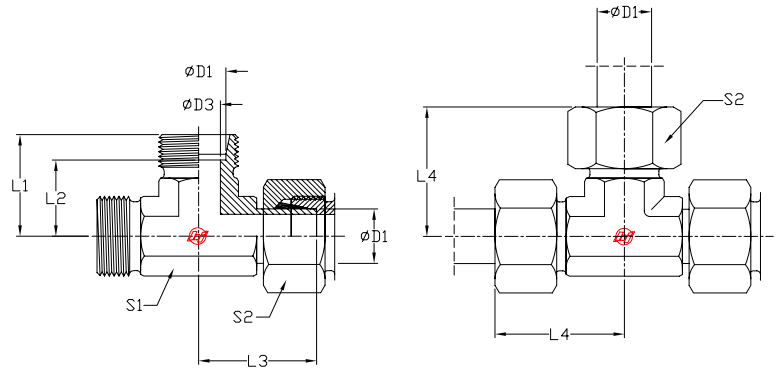

订货号	系列	钢管 外径	D3	L1	L2	L3	L4	S1	S2	PN(bar)	
		D1								C	SS
TTsT-L06-L06-L06	L	06	4.0	19.0	12.0	26.0	27.0	12	14	315	315
TTsT-L08-L08-L08		08	6.0	21.0	14.0	27.5	29.0	12	17	315	315
TTsT-L10-L10-L10		10	8.0	22.0	15.0	29.0	30.0	14	19	315	315
TTsT-L12-L12-L12		12	10.0	24.0	17.0	29.5	32.0	17	22	315	315
TTsT-L15-L15-L15		15	12.0	28.0	21.0	32.5	36.0	19	27	315	315
TTsT-L18-L18-L18		18	15.0	31.0	23.5	35.5	40.0	24	32	315	315
TTsT-L22-L22-L22		22	19.0	35.0	27.5	38.5	44.0	27	36	160	160
TTsT-L28-L28-L28		28	24.0	38.0	30.5	41.5	47.0	36	41	160	160
TTsT-L35-L35-L35		35	30.0	45.0	34.5	51.0	56.0	41	50	160	160
TTsT-L42-L42-L42		42	36.0	51.0	40.0	56.0	63.0	50	60	160	160
TTsT-S06-S06-S06	S	06	4.0	23.0	16.0	27.0	31.0	12	17	630	630
TTsT-S08-S08-S08		08	5.0	24.0	17.0	27.5	32.0	14	19	630	630
TTsT-S10-S10-S10		10	7.0	25.0	17.5	30.0	34.0	17	22	630	630
TTsT-S12-S12-S12		12	8.0	29.0	21.5	31.0	38.0	17	24	630	630
TTsT-S14-S14-S14		14	10.0	30.0	22.0	35.0	40.0	19	27	400	400
TTsT-S16-S16-S16		16	12.0	33.0	24.5	36.5	43.0	24	30	400	400
TTsT-S20-S20-S20		20	16.0	37.0	26.5	44.5	48.0	27	36	400	400
TTsT-S25-S25-S25		25	20.0	42.0	30.0	50.0	54.0	36	46	400	400
TTsT-S30-S30-S30		30	25.0	49.0	35.5	55.0	62.0	41	50	400	400
TTsT-S38-S38-S38		38	32.0	57.0	41.0	63.0	72.0	50	60	315	315

订货示例:

碳钢, 无六价铬镀锌: TTTs-L06-L06-L06

304不锈钢: TTTs-L06-L06-L06-304

316不锈钢: TTTs-L06-L06-L06-316

注: 订货号不含螺母卡套

注: 订货号含螺母卡套 TTTs-L06-L06-L06-NBR

00TSr 直通过渡组合接头

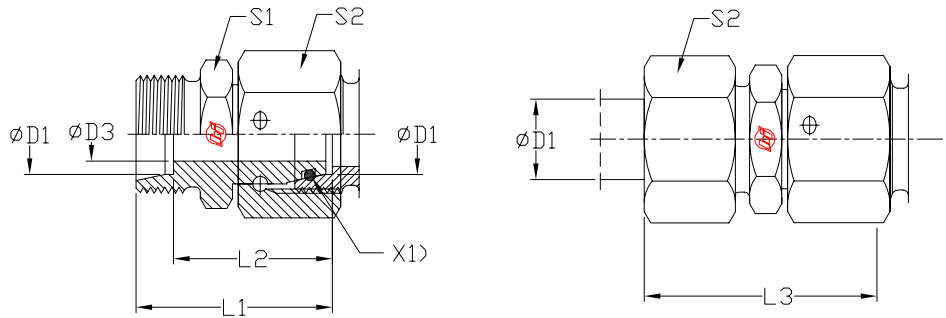

X1) O型圈

订货号	系列	钢管 外径								PN(bar)	
		D1	D3	L1	L2	L3	S1	S2	C	SS	
00TSr-L06-L06	L	06	2.5	43.0	36.0	51.0	12	14	500	315	
00TSr-L08-L08		08	4.0	43.0	36.0	51.0	14	17	500	315	
00TSr-L10-L10		10	6.0	43.0	36.0	51.0	17	19	500	315	
00TSr-L12-L12		12	8.0	43.0	36.0	51.0	19	22	400	315	
00TSr-L15-L15		15	10.0	43.0	36.0	51.0	24	27	400	315	
00TSr-L18-L18		18	13.0	43.5	36.0	52.0	27	32	400	315	
00TSr-L22-L22		22	17.0	47.5	40.0	56.0	32	36	250	160	
00TSr-L28-L28		28	22.0	47.5	40.0	57.0	41	41	250	160	
00TSr-L35-L35		35	28.0	60.5	50.0	72.0	46	50	250	160	
00TSr-L42-L42		42	34.0	71.0	60.0	83.0	55	60	250	160	
00TSr-S06-S06	S	06	2.5	43.0	36.0	51.0	14	17	800	630	
00TSr-S08-S08		08	4.0	43.0	36.0	51.0	17	19	800	630	
00TSr-S10-S10		10	6.0	43.5	36.0	52.0	19	22	800	630	
00TSr-S12-S12		12	8.0	43.5	36.0	52.0	22	24	630	630	
00TSr-S16-S16		16	11.0	48.5	40.0	58.0	27	30	630	400	
00TSr-S20-S20		20	14.0	56.5	46.0	68.0	32	36	420	400	
00TSr-S25-S25		25	18.0	62.0	50.0	74.0	41	46	420	400	
00TSr-S30-S30		30	23.0	69.5	56.0	83.0	46	50	420	400	
00TSr-S38-S38	38	30.0	76.0	60.0	91.0	55	60	420	315		

订货示例:

碳钢, 无六价铬镀锌: 00TSr-L06-L06

304不锈钢: 00TSr-L06-L06-304

316不锈钢: 00TSr-L06-L06-316

注: 订货号不含螺母卡套

注: 订货号含螺母卡套 00TSr-L06-L06-NBR

00TSr 直通变径组合接头

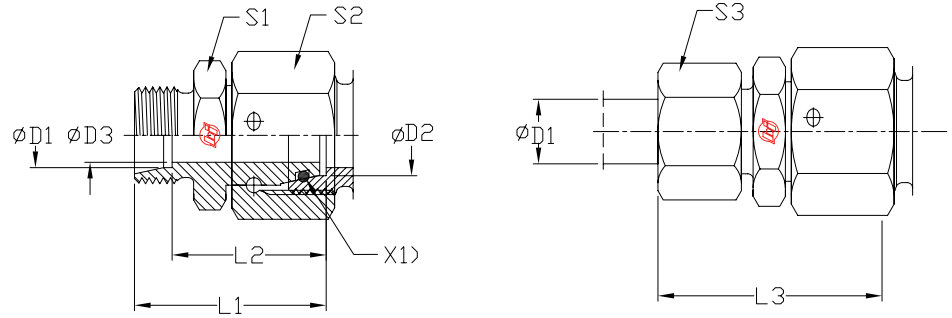

X1) O型圈

订货号	系列	钢管 外径	钢管 外径	D3	L1	L2	L3	S1	S2	S3	PN(bar)	
		D1	D2								C	SS
00TSr-L06-L08	L	06	08	4.0	30.5	23.5	38.0	12	17	14	500	315
00TSr-L06-L10	L	06	10	4.0	32.0	25.0	40.0	14	19	14	500	315
00TSr-L08-L10	L	08	10	6.0	32.0	25.0	40.0	14	19	17	500	315
00TSr-L06-L12	L	06	12	4.0	32.0	25.0	40.0	17	22	14	400	315
00TSr-L08-L12	L	08	12	6.0	32.0	25.0	40.0	17	22	17	400	315
00TSr-L10-L12	L	10	12	8.0	33.0	26.0	41.0	17	22	19	400	315
00TSr-L06-L15	L	06	15	4.0	35.5	28.5	43.0	19	27	14	400	315
00TSr-L08-L15	L	08	15	6.0	35.5	28.5	43.0	19	27	17	400	315
00TSr-L10-L15	L	10	15	8.0	36.5	29.5	44.0	19	27	19	400	315
00TSr-L12-L15	L	12	15	10.0	36.5	29.5	44.0	19	27	22	400	315
00TSr-L06-L18	L	06	18	4.0	35.0	28.0	43.0	24	32	14	400	315
00TSr-L08-L18	L	08	18	6.0	35.0	28.0	43.0	24	32	17	400	315
00TSr-L10-L18	L	10	18	8.0	36.0	29.0	44.0	24	32	19	400	315
00TSr-L12-L18	L	12	18	10.0	36.0	29.0	44.0	24	32	22	400	315
00TSr-L15-L18	L	15	18	12.0	37.0	30.0	45.0	24	32	27	400	315
00TSr-S16-L18	S/L	16	18	12.0	40.0	31.5	49.5	27	32	30	400	315
00TSr-L06-L22	L	06	22	4.0	39.0	32.0	47.0	27	36	14	250	160
00TSr-L08-L22	L	08	22	6.0	39.0	32.0	47.0	27	36	17	250	160
00TSr-L10-L22	L	10	22	8.0	40.0	33.0	48.0	27	36	19	250	160
00TSr-L12-L22	L	12	22	10.0	40.0	33.0	48.0	27	36	22	250	160
00TSr-L15-L22	L	15	22	12.0	41.0	34.0	49.0	27	36	27	250	160
00TSr-S16-L22	S/L	16	22	12.0	43.0	34.5	52.5	27	36	30	250	160
00TSr-L18-L22	L	18	22	15.0	41.0	33.5	50.0	27	36	32	250	160
00TSr-S20-L22	S/L	20	22	16.0	45.0	34.5	56.0	32	36	36	250	160
00TSr-L06-L28	L	06	28	4.0	41.0	34.0	49.0	32	41	14	250	160
00TSr-L08-L28	L	08	28	6.0	41.0	34.0	49.0	32	41	17	250	160
00TSr-L10-L28	L	10	28	8.0	42.0	35.0	50.0	32	41	19	250	160
00TSr-L12-L28	L	12	28	10.0	42.0	35.0	50.0	32	41	22	250	160
00TSr-L15-L28	L	15	28	12.0	43.0	36.0	51.0	32	41	27	250	160

00TSr 直通变径组合接头

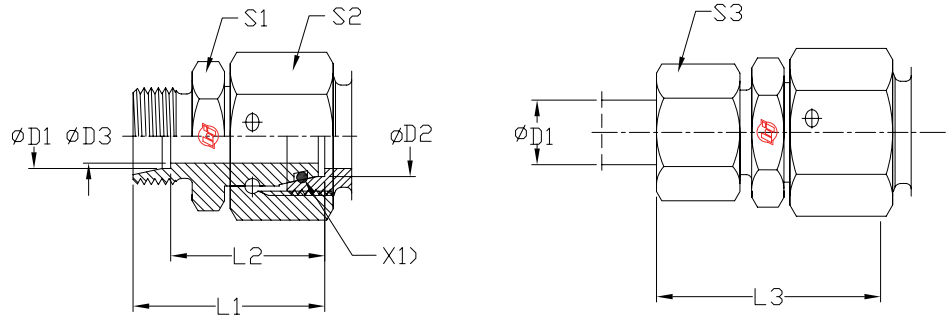

续上表

X1>0型圈

订货号	系列	钢管 外径		D3	L1	L2	L3	S1	S2	S3	PN(bar)	
		D1	D2								C	SS
00TSr-S16-L28	S/L	16	28	12.0	45.0	36.5	54.5	32	41	30	250	160
00TSr-L18-L28	L	18	28	15.0	43.0	35.5	52.0	32	41	32	250	160
00TSr-L22-L28	L	22	28	19.0	45.0	37.5	54.0	32	41	36	250	160
00TSr-S25-L28	S/L	25	28	20.0	50.0	38.0	62.0	41	41	46	250	160
00TSr-L06-L35	L	06	35	4.0	44.0	37.0	52.0	41	50	14	250	160
00TSr-L08-L35	L	08	35	6.0	44.0	37.0	52.0	41	50	17	250	160
00TSr-L10-L35	L	10	35	8.0	45.0	38.0	53.0	41	50	19	250	160
00TSr-L12-L35	L	12	35	10.0	45.0	38.0	53.0	41	50	22	250	160
00TSr-L15-L35	L	15	35	12.0	46.0	39.0	54.0	41	50	27	250	160
00TSr-L18-L35	L	18	35	15.0	46.0	38.5	55.0	41	50	32	250	160
00TSr-L22-L35	L	22	35	19.0	48.0	40.5	57.0	41	50	36	250	160
00TSr-S25-L35	S/L	25	35	20.0	52.0	40.0	64.0	41	50	46	250	160
00TSr-L28-L35	L	28	35	24.0	48.0	40.5	57.0	41	50	41	250	160
00TSr-S30-L35	S/L	30	35	25.0	55.0	41.5	68.0	46	50	50	250	160
00TSr-L10-L42	L	10	42	8.0	48.5	41.5	56.0	50	60	19	250	160
00TSr-L12-L42	L	12	42	10.0	48.5	41.5	56.0	50	60	22	250	160
00TSr-L15-L42	L	15	42	12.0	49.5	42.5	58.0	50	60	27	250	160
00TSr-L18-L42	L	18	42	15.0	49.5	42.0	58.0	50	60	32	250	160
00TSr-L22-L42	L	22	42	19.0	51.5	44.0	60.0	50	60	36	250	160
00TSr-L28-L42	L	28	42	24.0	51.5	44.0	61.0	50	60	41	250	160
00TSr-S30-L42	S/L	30	42	25.0	57.5	44.0	70.5	50	60	50	250	160
00TSr-L35-L42	L	35	42	30.0	53.5	43.0	65.0	50	60	50	250	160
00TSr-S38-L42	S/L	38	42	32.0	61.5	45.5	76.0	55	60	60	250	160

订货示例:

碳钢, 无六价铬镀锌: 00TSr-L06-L08

304不锈钢: 00TSr-L06-L08-304

316不锈钢: 00TSr-L06-L08-316

注: 订货号不含螺母卡套

注: 订货号含螺母卡套 00TSr-L06-L08-NBR

00TSr 直通变径组合接头

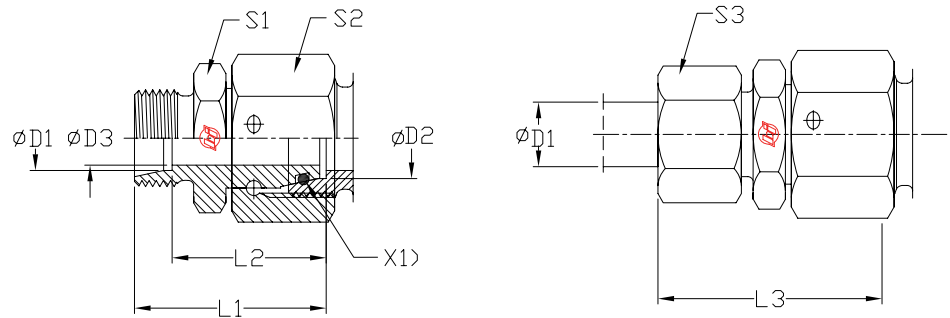

X1) O型圈

订货号	系列	钢管	钢管	D3	L1	L2	L3	S1	S2	S3	PN(bar)	
		外径	外径								C	SS
		D1	D2									
00TSr-S06-S08	S	06	08	4.0	34.0	27.0	42.0	14	19	17	800	630
00TSr-S06-S10	S	06	10	4.0	34.5	27.5	42.0	17	22	17	800	630
00TSr-S08-S10	S	08	10	5.0	34.5	27.5	42.0	17	22	19	800	630
00TSr-S06-S12	S	06	12	4.0	36.0	29.0	44.0	17	24	17	630	630
00TSr-S08-S12	S	08	12	5.0	36.0	29.0	44.0	17	24	19	630	630
00TSr-S10-S12	S	10	12	7.0	37.0	29.5	46.0	19	24	22	630	630
00TSr-S06-S16	S	06	16	4.0	39.0	32.0	47.0	22	30	17	630	400
00TSr-S08-S16	S	08	16	5.0	39.0	32.0	47.0	22	30	19	630	400
00TSr-S10-S16	S	10	16	7.0	39.0	31.5	48.0	22	30	22	630	400
00TSr-S12-S16	S	12	16	8.0	39.0	31.5	48.0	22	30	24	630	400
00TSr-L15-S16	L/S	15	16	11.0	39.0	32.0	47.0	24	30	27	400	315
00TSr-S06-S20	S	06	20	4.0	43.0	36.0	51.0	27	36	17	420	400
00TSr-S08-S20	S	08	20	5.0	43.0	36.0	51.0	27	36	19	420	400
00TSr-S10-S20	S	10	20	7.0	43.0	35.5	52.0	27	36	22	420	400
00TSr-S12-S20	S	12	20	8.0	43.0	35.5	52.0	27	36	24	420	400
00TSr-L15-S20	L/S	15	20	12.0	43.0	36.0	51.0	27	36	27	400	315
00TSr-S16-S20	S	16	20	12.0	45.0	36.5	55.0	27	36	30	420	400
00TSr-L18-S20	L/S	18	20	14.0	43.0	35.5	51.0	27	36	32	400	315
00TSr-S06-S25	S	06	25	4.0	45.5	38.5	53.0	32	46	17	420	400
00TSr-S08-S25	S	08	25	5.0	45.5	38.5	53.0	32	46	19	420	400
00TSr-S10-S25	S	10	25	7.0	45.5	38.0	54.0	32	46	22	420	400
00TSr-S12-S25	S	12	25	8.0	45.5	38.0	54.0	32	46	24	420	400
00TSr-S16-S25	S	16	25	12.0	47.5	39.0	57.0	32	46	30	420	400
00TSr-L18-S25	L/S	18	25	15.0	45.5	38.0	54.0	32	46	32	400	315
00TSr-S20-S25	S	20	25	16.0	49.5	39.0	61.0	32	46	36	420	400
00TSr-L22-S25	L/S	22	25	18.0	47.5	40.0	56.0	32	46	36	250	160
00TSr-S06-S30	S	06	30	4.0	51.0	44.0	59.0	41	50	17	420	400
00TSr-S08-S30	S	08	30	5.0	51.0	44.0	59.0	41	50	19	420	400

00TSr 直通变径组合接头

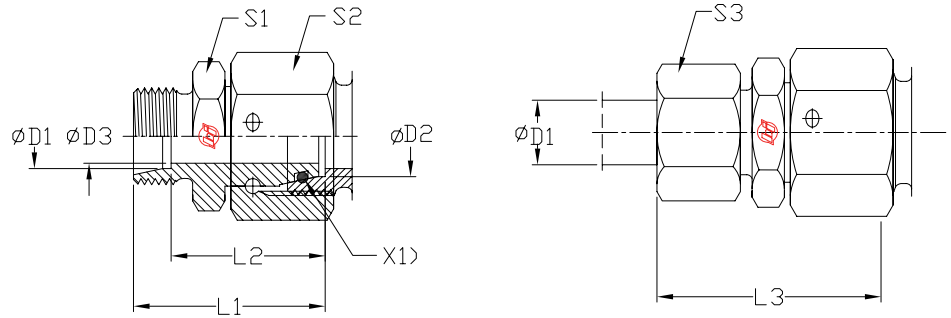

续上表

X1) O型圈

订货号	系列	钢管 外径	钢管 外径	D3	L1	L2	L3	S1	S2	S3	PN(bar)	
		D1	D2								C	SS
00TSr-S10-S30	S	10	30	7.0	51.0	43.5	60.0	41	50	22	420	400
00TSr-S12-S30	S	12	30	8.0	51.0	43.5	60.0	41	50	24	420	400
00TSr-S16-S30	S	16	30	12.0	53.0	44.5	63.0	41	50	30	420	400
00TSr-S20-S30	S	20	30	16.0	55.0	44.5	66.0	41	50	36	420	400
00TSr-L22-S30	L/S	22	30	19.0	53.0	45.5	61.0	41	50	36	250	160
00TSr-S25-S30	S	25	30	20.0	57.0	45.0	69.0	41	50	46	420	400
00TSr-L28-S30	L/S	28	30	23.0	53.0	45.5	62.0	41	50	41	250	160
00TSr-S06-S38	S	06	38	4.0	54.5	47.5	62.0	50	60	17	420	315
00TSr-S08-S38	S	08	38	5.0	54.5	47.5	62.0	50	60	19	420	315
00TSr-S10-S38	S	10	38	7.0	54.5	47.0	63.0	50	60	22	420	315
00TSr-S12-S38	S	12	38	8.0	54.5	47.0	63.0	50	60	24	420	315
00TSr-S14-S38	S	14	38	10.0	56.5	48.5	66.0	50	60	27	420	315
00TSr-S16-S38	S	16	38	12.0	56.5	48.0	66.0	50	60	30	420	315
00TSr-S20-S38	S	20	38	16.0	58.5	48.0	70.0	50	60	36	420	315
00TSr-S25-S38	S	25	38	20.0	60.5	48.5	73.0	50	60	46	420	315
00TSr-L28-S38	L/S	28	38	24.0	56.5	49.0	65.0	50	60	41	250	160
00TSr-S30-S38	S	30	38	25.0	62.5	49.0	76.0	50	60	50	420	315
00TSr-L35-S38	L/S	35	38	30.0	58.5	48.0	69.0	50	60	50	250	160

订货示例:

碳钢, 无六价铬镀锌: 00TSr-S06-S08

304不锈钢: 00TSr-S06-S08-304

316不锈钢: 00TSr-S06-S08-316

注: 订货号不含螺母卡套

注: 订货号含螺母卡套 00TSr-S06-S08-NBR

00TTs 直通变径金属组合接头

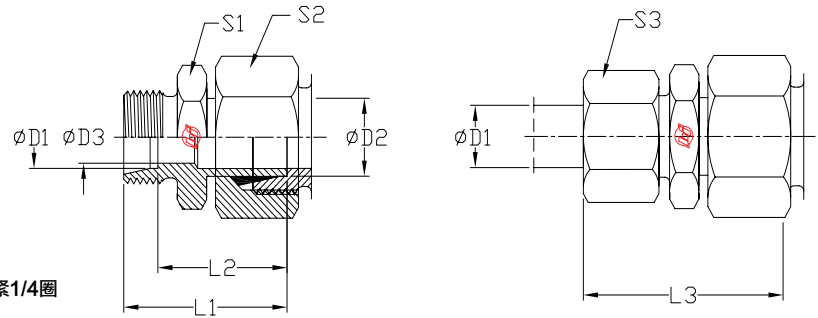

卡套已预装，最终装配时从力矩激增点起最少拧紧1/4圈

订货号	系列	钢管	钢管	D3	L1	L2	L3	S1	S2	S3	PN(bar)	
		外径	外径								C	SS
		D1	D2									
00TTs-L06-L08	L	06	08	4.0	33.5	26.5	41.0	12	17	14	315	315
00TTs-L06-L10		06	10	4.0	34.5	27.5	42.0	12	19	14	315	315
00TTs-L08-L10		08	10	6.0	35.5	28.5	43.0	14	19	17	315	315
00TTs-L06-L12		06	12	4.0	36.5	29.5	44.0	14	22	14	315	315
00TTs-L08-L12		08	12	6.0	36.5	29.5	44.0	14	22	17	315	315
00TTs-L10-L12		10	12	8.0	37.5	30.5	45.0	17	22	19	315	315
00TTs-L06-L15		06	15	4.0	37.0	30.0	45.0	17	27	14	315	315
00TTs-L08-L15		08	15	6.0	37.0	30.0	45.0	17	27	17	315	315
00TTs-L10-L15		10	15	8.0	38.0	31.0	46.0	17	27	19	315	315
00TTs-L12-L15		12	15	10.0	39.0	32.0	47.0	19	27	22	315	315
00TTs-L06-L18		06	18	4.0	37.5	30.5	45.0	19	32	14	315	315
00TTs-L08-L18		08	18	6.0	37.5	30.5	45.0	19	32	17	315	315
00TTs-L10-L18		10	18	8.0	38.5	31.5	46.0	19	32	19	315	315
00TTs-L12-L18		12	18	10.0	38.5	31.5	46.0	19	32	22	315	315
00TTs-L15-L18		15	18	12.0	39.5	32.5	48.0	24	32	27	315	315
00TTs-L06-L22		06	22	4.0	38.5	31.5	46.0	24	36	14	160	160
00TTs-L08-L22		08	22	6.0	38.5	31.5	46.0	24	36	17	160	160
00TTs-L10-L22		10	22	8.0	39.5	32.5	47.0	24	36	19	160	160
00TTs-L12-L22		12	22	10.0	39.5	32.5	47.0	24	36	22	160	160
00TTs-L15-L22		15	22	12.0	40.5	33.5	49.0	24	36	27	160	160
00TTs-L18-L22		18	22	15.0	41.5	34.0	50.0	27	36	32	160	160
00TTs-L06-L28		06	28	4.0	41.0	34.0	49.0	30	41	14	160	160
00TTs-L08-L28		08	28	6.0	41.0	34.0	49.0	30	41	17	160	160
00TTs-L10-L28		10	28	8.0	42.0	35.0	50.0	30	41	19	160	160
00TTs-L12-L28		12	28	10.0	42.0	35.0	50.0	30	41	22	160	160
00TTs-L15-L28		15	28	12.0	43.0	36.0	51.0	30	41	27	160	160
00TTs-L18-L28		18	28	15.0	43.0	35.5	52.0	30	41	32	160	160
00TTs-L22-L28		22	28	19.0	45.0	37.5	54.0	32	41	36	160	160
00TTs-L06-L35		06	35	4.0	48.5	41.5	56.0	36	50	14	160	160
00TTs-L08-L35		08	35	6.0	48.5	41.5	56.0	36	50	17	160	160
00TTs-L10-L35		10	35	8.0	49.5	42.5	57.0	36	50	19	160	160
00TTs-L12-L35		12	35	10.0	49.5	42.5	57.0	36	50	22	160	160
00TTs-L15-L35		15	35	12.0	50.5	43.5	59.0	36	50	27	160	160
00TTs-L18-L35		18	35	15.0	50.5	43.0	59.0	36	50	32	160	160
00TTs-L22-L35		22	35	19.0	52.5	45.0	61.0	36	50	36	160	160
00TTs-L28-L35		28	35	24.0	52.5	45.0	62.0	41	50	41	160	160
00TTs-L10-L42		10	42	8.0	52.5	45.5	60.0	46	60	19	160	160
00TTs-L12-L42		12	42	10.0	52.5	45.5	60.0	46	60	22	160	160
00TTs-L15-L42		15	42	12.0	53.5	46.5	62.0	46	60	27	160	160
00TTs-L18-L42		18	42	15.0	53.5	46.0	62.0	46	60	32	160	160
00TTs-L22-L42		22	42	19.0	55.5	48.0	64.0	46	60	36	160	160
00TTs-L28-L42		28	42	24.0	55.5	48.0	65.0	46	60	41	160	160
00TTs-L35-L42	35	42	30.0	57.5	47.0	69.0	46	60	50	160	160	

00TTs 直通变径金属组合接头

续上表

订货号	系列	钢管 外径	钢管 外径	D3	L1	L2	L3	S1	S2	S3	PN(bar)	
		D1	D2								C	SS
00TTs-S06-S08	S	06	08	4.0	36.5	29.5	44.0	14	19	17	630	630
00TTs-S06-S10		06	10	4.0	38.5	31.5	46.0	14	22	17	630	630
00TTs-S08-S10		08	10	5.0	38.5	31.5	46.0	17	22	19	630	630
00TTs-S06-S12		06	12	4.0	38.5	31.5	46.0	14	24	17	630	630
00TTs-S08-S12		08	12	5.0	38.5	31.5	46.0	17	24	19	630	630
00TTs-S10-S12		10	12	7.0	39.5	32.0	48.0	19	24	22	630	630
00TTs-S06-S14		06	14	4.0	40.5	33.5	48.0	17	27	17	630	630
00TTs-S08-S14		08	14	5.0	40.5	33.5	48.0	17	27	19	630	630
00TTs-S10-S14		10	14	7.0	41.5	34.0	50.0	19	27	22	630	630
00TTs-S12-S14		12	14	8.0	41.5	34.0	50.0	22	27	24	630	630
00TTs-S06-S16		06	16	4.0	41.0	34.0	49.0	17	30	17	400	400
00TTs-S08-S16		08	16	5.0	41.0	34.0	49.0	17	30	19	400	400
00TTs-S10-S16		10	16	7.0	42.0	34.5	51.0	19	30	22	400	400
00TTs-S12-S16		12	16	8.0	42.0	34.5	51.0	22	30	24	400	400
00TTs-S14-S16		14	16	10.0	44.0	36.0	54.0	24	30	27	400	400
00TTs-S06-S20		06	20	4.0	46.0	39.0	54.0	22	36	17	400	400
00TTs-S08-S20		08	20	5.0	46.0	39.0	54.0	22	36	19	400	400
00TTs-S10-S20		10	20	7.0	46.0	38.5	55.0	22	36	22	400	400
00TTs-S12-S20		12	20	8.0	46.0	38.5	55.0	22	36	24	400	400
00TTs-S14-S20		14	20	10.0	48.0	40.0	58.0	24	36	27	400	400
00TTs-S16-S20		16	20	12.0	49.0	40.5	59.0	27	36	30	400	400
00TTs-S06-S25		06	25	4.0	50.5	43.5	58.0	27	46	17	400	400
00TTs-S08-S25		08	25	5.0	50.5	43.5	58.0	27	46	19	400	400
00TTs-S10-S25		10	25	7.0	50.5	43.0	59.0	27	46	22	400	400
00TTs-S12-S25		12	25	8.0	50.5	43.0	59.0	27	46	24	400	400
00TTs-S14-S25		14	25	10.0	52.5	44.5	62.0	27	46	27	400	400
00TTs-S16-S25		16	25	12.0	52.5	44.0	62.0	27	46	30	400	400
00TTs-S20-S25		20	25	16.0	54.5	44.0	66.0	32	46	36	400	400
00TTs-S06-S30		06	30	4.0	53.0	46.0	61.0	32	50	17	400	400
00TTs-S08-S30		08	30	5.0	53.0	46.0	61.0	32	50	19	400	400
00TTs-S10-S30		10	30	7.0	53.0	45.5	62.0	32	50	22	400	400
00TTs-S12-S30		12	30	8.0	53.0	45.5	62.0	32	50	24	400	400
00TTs-S14-S30		14	30	10.0	55.0	47.0	65.0	32	50	27	400	400
00TTs-S16-S30		16	30	12.0	55.0	46.5	65.0	32	50	30	400	400
00TTs-S20-S30		20	30	16.0	57.0	46.5	68.0	32	50	36	400	400
00TTs-S25-S30		25	30	20.0	60.0	48.0	72.0	41	50	46	400	400
00TTs-S06-S38		06	38	4.0	60.0	53.0	68.0	41	60	17	315	315
00TTs-S08-S38		08	38	5.0	60.0	53.0	68.0	41	60	19	315	315
00TTs-S10-S38		10	38	7.0	60.0	52.5	69.0	41	60	22	315	315
00TTs-S12-S38		12	38	8.0	60.0	52.5	69.0	41	60	24	315	315
00TTs-S14-S38	14	38	10.0	62.0	54.0	72.0	41	60	27	315	315	
00TTs-S16-S38	16	38	12.0	62.0	53.5	72.0	41	60	30	315	315	
00TTs-S20-S38	20	38	16.0	64.0	53.5	75.0	41	60	36	315	315	
00TTs-S25-S38	25	38	20.0	66.0	54.0	78.0	41	60	46	315	315	
00TTs-S30-S38	30	38	25.0	69.0	55.5	82.0	46	60	50	315	315	

订货示例:

碳钢, 无六价铬镀锌: 00TTs-S06-S08

304不锈钢: 00TTs-S06-S08-304

316不锈钢: 00TTs-S06-S08-316

注: 订货号不含螺母卡套

注: 订货号含螺母卡套 00TTs-S06-S08-NBR

00SrSr 直通组合接头

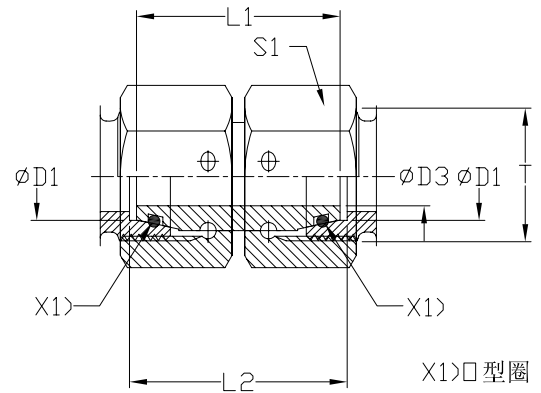

订货号	系列	钢管 外径	T	D3	L1	L2	S1	PN(bar)	
		D1						C	SS
00SrSr-L06-L06	L	06	M 12x1.5	2.5	32.0	33.0	14	500	315
00SrSr-L08-L08		08	M 14x1.5	4.0	32.0	33.0	17	500	315
00SrSr-L10-L10		10	M 16x1.5	6.0	33.0	34.0	19	500	315
00SrSr-L12-L12		12	M 18x1.5	8.0	33.0	34.0	22	400	315
00SrSr-L15-L15		15	M 22x1.5	10.0	38.0	39.0	27	400	315
00SrSr-L18-L18		18	M 26x1.5	13.0	36.0	38.0	32	400	315
00SrSr-L22-L22		22	M 30x2.0	17.0	42.0	44.0	36	250	160
00SrSr-L28-L28		28	M 36x2.0	22.0	46.0	48.0	41	250	160
00SrSr-L35-L35		35	M 45x2.0	28.0	48.0	52.0	50	250	160
00SrSr-L42-L42		42	M 52x2.0	34.0	52.0	57.0	60	250	160
00SrSr-S06-S06	S	06	M 14x1.5	2.5	32.0	33.0	17	800	630
00SrSr-S08-S08		08	M 16x1.5	4.0	33.0	34.0	19	800	630
00SrSr-S10-S10		10	M 18x1.5	6.0	33.0	35.0	22	800	630
00SrSr-S12-S12		12	M 20x1.5	8.0	36.0	38.0	24	630	630
00SrSr-S14-S14		14	M 22x1.5	9.0	39.0	41.0	27	630	630
00SrSr-S16-S16		16	M 24x1.5	11.0	39.0	42.0	30	630	400
00SrSr-S20-S20		20	M 30x2.0	14.0	44.0	48.0	36	420	400
00SrSr-S25-S25		25	M 36x2.0	18.0	46.0	53.0	46	420	400
00SrSr-S30-S30		30	M 42x2.0	23.0	52.0	62.0	50	420	400
00SrSr-S38-S38		38	M 52x2.0	30.0	52.0	67.0	60	420	315

订货示例:

碳钢, 无六价铬镀锌: 00SrSr-L06-L06

304不锈钢: 00SrSr-L06-L06-304

316不锈钢: 00SrSr-L06-L06-316

00SrSr 直通组合变径接头

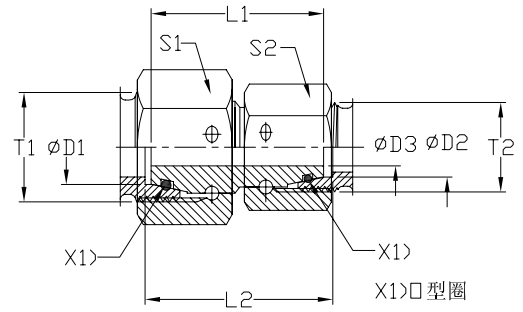

订货号	系列	钢管	钢管	T1	T2	D3	L1	L2	S1	S2	PN(bar)	
		外径	外径								C	SS
		D1	D2									
00SrSr-L06-S06	L/S	06	06	M 14x1.5	M 12x1.5	2.5	32.0	33.0	17	14	500	500
00SrSr-L08-L06	L	08	06	M 14x1.5	M 12x1.5	2.5	32.0	33.0	17	14	500	500
00SrSr-L08-S08	L/S	08	08	M 16x1.5	M 14x1.5	4.0	33.0	34.0	19	17	500	500
00SrSr-L10-L06	L	10	06	M 16x1.5	M 12x1.5	2.5	33.0	34.0	19	14	500	500
00SrSr-L10-L08	L	10	08	M 16x1.5	M 14x1.5	4.0	33.0	34.0	19	17	500	500
00SrSr-L10-S10	L/S	10	10	M 18x1.5	M 16x1.5	6.0	33.0	34.5	22	19	500	500
00SrSr-L12-L06	L	12	06	M 18x1.5	M 12x1.5	2.5	33.0	34.0	22	14	400	400
00SrSr-L12-L08	L	12	08	M 18x1.5	M 14x1.5	4.0	33.0	34.0	22	17	400	400
00SrSr-L12-L10	L	12	10	M 18x1.5	M 16x1.5	6.0	33.0	34.0	22	19	400	400
00SrSr-L12-S12	L/S	12	12	M 20x1.5	M 18x1.5	8.0	36.0	37.5	24	22	400	400
00SrSr-L15-L08	L	15	08	M 22x1.5	M 14x1.5	4.0	38.0	39.0	27	17	400	400
00SrSr-L15-L10	L	15	10	M 22x1.5	M 16x1.5	6.0	38.0	39.0	27	19	400	400
00SrSr-L15-L12	L	15	12	M 22x1.5	M 18x1.5	8.0	38.0	39.0	27	22	400	400
00SrSr-L18-L10	L	18	10	M 26x1.5	M 16x1.5	6.0	36.0	37.5	32	19	400	400
00SrSr-L18-L12	L	18	12	M 26x1.5	M 18x1.5	8.0	36.0	37.5	32	22	400	400
00SrSr-L18-L15	L	18	15	M 26x1.5	M 22x1.5	10.0	38.0	39.5	32	27	400	400
00SrSr-L18-S16	L/S	18	16	M 26x1.5	M 24x1.5	11.0	39.0	41.5	32	30	400	400
00SrSr-L22-L12	L	22	12	M 30x2.0	M 18x1.5	8.0	42.0	43.5	36	22	250	250
00SrSr-L22-L15	L	22	15	M 30x2.0	M 22x1.5	10.0	42.0	43.5	36	27	250	250
00SrSr-L22-L18	L	22	18	M 30x2.0	M 26x1.5	13.0	42.0	44.0	36	32	250	250
00SrSr-L22-S20	L/S	22	20	M 30x2.0	M 30x2.0	14.0	44.0	47.0	36	36	250	250
00SrSr-L28-L15	L	28	15	M 36x2.0	M 22x1.5	10.0	46.0	47.5	41	27	250	250
00SrSr-L28-L18	L	28	18	M 36x2.0	M 26x1.5	13.0	46.0	48.0	41	32	250	250
00SrSr-L28-L22	L	28	22	M 36x2.0	M 30x2.0	17.0	46.0	46.0	41	36	250	250
00SrSr-L28-S25	L/S	28	25	M 36x2.0	M 36x2.0	18.0	46.0	50.5	41	46	250	250
00SrSr-L35-L18	L	35	18	M 45x2.0	M 26x1.5	13.0	48.0	51.0	50	32	250	250
00SrSr-L35-L22	L	35	22	M 45x2.0	M 30x2.0	17.0	48.0	51.0	50	36	250	250
00SrSr-L35-L28	L	35	28	M 45x2.0	M 36x2.0	22.0	48.0	51.0	50	41	250	250
00SrSr-L35-S30	L/S	35	30	M 45x2.0	M 42x2.0	23.0	52.0	59.0	50	50	250	250
00SrSr-L42-L22	L	42	22	M 52x2.0	M 30x2.0	17.0	52.0	55.5	60	36	250	250
00SrSr-L42-L28	L	42	28	M 52x2.0	M 36x2.0	22.0	52.0	55.5	60	41	250	250

00SrSr 直通组合变径接头

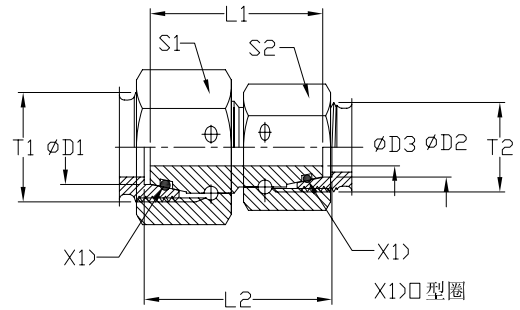

续上表

订货号	系列	钢管 外径	钢管 外径	T1	T2	D3	L1	L2	S1	S2	PN(bar)	
		D1	D2								C	SS
00SrSr-L42-L35	L	42	35	M 52x2.0	M 45x2.0	28.0	52.0	56.5	60	50	250	250
00SrSr-L42-S38	L/S	42	38	M 52x2.0	M 52x2.0	30.0	52.0	62.0	60	60	250	250
00SrSr-S08-S06	S	08	06	M 16x1.5	M 14x1.5	2.5	33.0	34.0	19	17	800	800
00SrSr-S10-S06	S	10	06	M 18x1.5	M 14x1.5	2.5	33.0	34.5	22	17	800	800
00SrSr-S10-S08	S	10	08	M 18x1.5	M 16x1.5	4.0	33.0	34.5	22	19	800	800
00SrSr-S12-S06	S	12	06	M 20x1.5	M 14x1.5	2.5	36.0	37.5	24	17	630	630
00SrSr-S12-S08	S	12	08	M 20x1.5	M 16x1.5	4.0	36.0	37.5	24	19	630	630
00SrSr-S12-S10	S	12	10	M 20x1.5	M 18x1.5	6.0	36.0	38.0	24	22	630	630
00SrSr-S16-S10	S	16	10	M 24x1.5	M 18x1.5	6.0	39.0	41.5	30	22	630	630
00SrSr-S16-S12	S	16	12	M 24x1.5	M 20x1.5	8.0	39.0	41.5	30	24	630	630
00SrSr-S16-L15	S/L	16	15	M 24x1.5	M 22x1.5	10.0	39.0	41.0	30	27	400	400
00SrSr-S20-S12	S	20	12	M 30x2.0	M 20x1.5	8.0	44.0	47.0	36	24	420	420
00SrSr-S20-S16	S	20	16	M 30x2.0	M 24x1.5	11.0	44.0	47.5	36	30	420	420
00SrSr-S20-L18	S/L	20	18	M 30x2.0	M 26x1.5	13.0	44.0	47.0	36	32	400	400
00SrSr-S25-S16	S	25	16	M 36x2.0	M 24x1.5	11.0	46.0	51.0	46	30	420	420
00SrSr-S25-S20	S	25	20	M 36x2.0	M 30x2.0	14.0	46.0	51.5	46	36	420	420
00SrSr-S25-L22	S/L	25	22	M 36x2.0	M 30x2.0	17.0	46.0	50.5	46	36	250	250
00SrSr-S30-S16	S	30	16	M 42x2.0	M 24x1.5	11.0	52.0	58.5	50	30	420	420
00SrSr-S30-S20	S	30	20	M 42x2.0	M 30x2.0	14.0	52.0	59.0	50	36	420	420
00SrSr-S30-S25	S	30	25	M 42x2.0	M 36x2.0	18.0	52.0	60.5	50	46	420	420
00SrSr-S30-L28	S/L	30	28	M 42x2.0	M 36x2.0	22.0	52.0	58.0	50	41	250	250
00SrSr-S38-S20	S	38	20	M 52x2.0	M 30x2.0	14.0	52.0	61.5	60	36	420	420
00SrSr-S38-S25	S	38	25	M 52x2.0	M 36x2.0	18.0	52.0	63.0	60	46	420	420
00SrSr-S38-S30	S	38	30	M 52x2.0	M 42x2.0	23.0	52.0	64.5	60	50	420	420
00SrSr-S38-L35	S/L	38	35	M 52x2.0	M 45x2.0	28.0	52.0	61.5	60	50	250	250

订货示例:

碳钢, 无六价铬镀锌: 00SrSr-L06-L06

304不锈钢: 00SrSr-L06-L06-304

316不锈钢: 00SrSr-L06-L06-316

00T0m/00T0n 端直通接头—公制螺纹O型圈密封

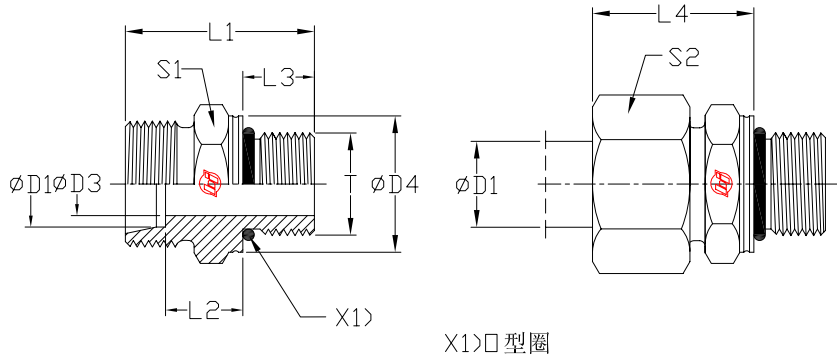

订货号	系列	钢管 外径	T	D3	D4	L1	L2	L3	L4	S1	S2	PN(bar)	
		D1										C	SS
00T0m-L06-M10*1.0	L	06	M 10x1.0	4.5	14.0	24.0	8.5	8.5	23.0	14	14	500	315
00T0m-L08-M12*1.5		08	M 12x1.5	6.0	17.0	28.0	10.0	11.0	25.0	17	17	500	315
00T0m-L10-M14*1.5		10	M 14x1.5	7.5	19.0	29.0	11.0	11.0	26.0	19	19	500	315
00T0m-L12-M16*1.5		12	M 16x1.5	9.0	22.0	31.0	12.5	11.5	27.0	22	22	400	315
00T0m-L15-M18*1.5		15	M 18x1.5	11.0	24.0	33.0	13.5	12.5	29.0	24	27	400	315
00T0m-L18-M22*1.5		18	M 22x1.5	14.0	27.0	35.0	14.5	13.0	31.0	27	32	400	315
00T0m-L22-M27*2.0		22	M 27x2.0	18.0	32.0	40.0	16.5	16.0	33.0	32	36	250	160
00T0m-L28-M33*2.0		28	M 33x2.0	23.0	41.0	41.0	17.5	16.0	34.0	41	41	250	160
00T0m-L35-M42*2.0		35	M 42x2.0	30.0	50.0	44.0	17.5	16.0	39.0	50	50	250	160
00T0m-L42-M48*2.0		42	M 48x2.0	36.0	55.0	47.5	19.0	17.5	42.0	55	60	250	160
00T0n-S06-M12*1.5	S	06	M 12x1.5	4.0	17.0	31.0	13.0	11.0	28.0	17	17	800	630
00T0n-S08-M14*1.5		08	M 14x1.5	6.0	19.0	33.0	15.0	11.0	30.0	19	19	800	630
00T0n-S10-M16*1.5		10	M 16x1.5	7.0	22.0	35.0	15.0	12.5	31.0	22	22	800	630
00T0n-S12-M18*1.5		12	M 18x1.5	9.0	24.0	38.5	17.0	14.0	33.0	24	24	630	630
00T0n-S16-M22*1.5		16	M 22x1.5	12.0	27.0	42.0	18.5	15.0	37.0	27	30	630	400
00T0n-S20-M27*2.0		20	M 27x2.0	15.0	32.0	49.5	20.5	18.5	42.0	32	36	420	400
00T0n-S25-M33*2.0		25	M 33x2.0	20.0	41.0	53.5	23.0	18.5	47.0	41	46	420	400
00T0n-S30-M42*2.0		30	M 42x2.0	26.0	50.0	56.0	23.5	19.0	50.0	50	50	420	400
00T0n-S38-M48*2.0		38	M 48x2.0	32.0	55.0	63.5	26.0	21.5	57.0	55	60	420	315

订货示例:

碳钢, 无六价铬镀锌: 00T0m-L06-M10x1.0

304不锈钢: 00T0m-L06-M10x1.0-304

316不锈钢: 00T0m-L06-M10x1.0-316

注: 订货号不含螺母卡套

注: 订货号含螺母卡套 00T0m-L06-M10x1.0-NBR

00Tot 端直通接头—英制螺纹O型圈密封

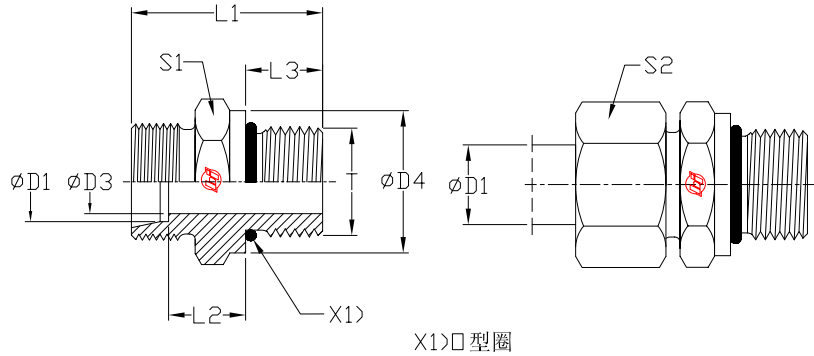

订货号	系列	钢管 外径	T	D3	D4	L1	L2	L3	S1	S2	PN(bar)	
		D1									C	SS
00Tot-L08-04	L	08	G1/4A	6.0	17.0	29.0	10.0	12.0	19	17	500	315
00Tot-L10-04		10	G1/4A	7.5	19.0	30.0	11.0	12.0	19	19	500	315
00Tot-L10-06		10	G3/8A	7.5	19.0	31.5	12.5	12.0	22	19	420	315
00Tot-L10-08		10	G1/2A	7.5	19.0	34.0	13.0	14.0	27	19	400	315
00Tot-L12-04		12	G1/4A	9.0	19.0	31.0	11.0	12.0	19	22	420	420
00Tot-L12-06		12	G3/8A	9.0	22.0	31.5	12.5	12.0	22	22	420	315
00Tot-L12-08		12	G1/2A	9.0	22.0	34.0	13.0	14.0	27	22	400	315
00Tot-L15-06		15	G3/8A	11.0	24.0	32.5	13.5	12.0	24	27	400	315
00Tot-L15-08		15	G1/2A	11.0	24.0	35.0	14.0	14.0	27	27	400	315
00Tot-L15-12		15	G3/4A	11.0	24.0	38.0	15.0	16.0	32	27	250	160
00Tot-L18-06		18	G3/8A	14.0	27.0	33.5	14.0	12.0	27	32	400	315
00Tot-L18-08		18	G1/2A	14.0	27.0	36.0	14.5	14.0	27	32	400	315
00Tot-L18-12		18	G3/4A	14.0	27.0	38.0	14.5	16.0	32	32	250	160
00Tot-L22-08		22	G1/2A	19.0	27.0	38.0	16.0	15.0	32	36	250	250
00Tot-L22-12		22	G3/4A	18.0	32.0	40.0	16.0	16.0	32	36	250	160
00Tot-L22-16		22	G1 A	18.0	32.0	43.0	17.5	18.0	41	36	250	160
00Tot-L28-12		28	G3/4A	18.0	32.0	41.0	17.0	16.0	41	41	250	250
00Tot-L28-16		28	G1 A	23.0	41.0	42.0	16.0	18.0	41	41	250	250
00Tot-L35-12		35	G3/4A	30.0	50.0	46.0	17.5	18.0	46	50	250	160
00Tot-S20-12		S	20	G3/4A	15.0	32.0	47.0	20.5	16.0	32	36	420
00Tot-S25-12	25		G3/4A	20.0	41.0	51.0	23.0	16.0	41	46	420	400
00Tot-S25-16	25		G1 A	20.0	41.0	53.0	23.0	18.0	41	46	420	400
00Tot-S30-12	30		G3/4A	25.0	32.0	53.0	23.0	16.0	46	50	420	400
00Tot-S30-16	30		G1 A	26.0	50.0	55.0	23.5	18.0	46	50	420	400

订货示例:

碳钢, 无六价铬镀锌: 00Tot-L08-04

304不锈钢: 00Tot-L08-04-304

316不锈钢: 00Tot-L08-04-316

注: 订货号不含螺母卡套

注: 订货号含螺母卡套 00Tot-L08-04-NBR

00TOe/00TOf 端直通接头—公制螺纹ED型密封

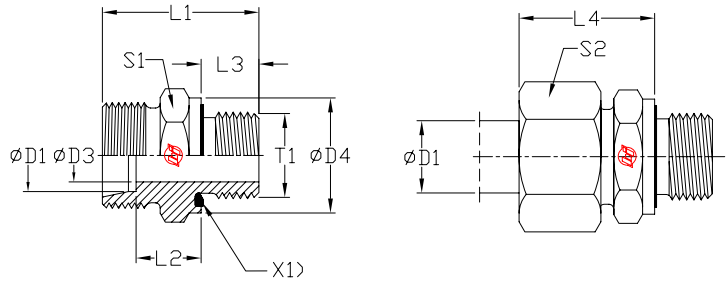

X1) ED 圈

订货号	系列	钢管 外径	T1	D3	D4	L1	L2	L3	L4	S1	S2	PN(bar)	
												C	SS
00TOe-L06-M10*1.0	L	06	M 10x1.0	4.0	14.0	23.5	8.5	8.0	23.0	14	14	500	315
00TOe-L08-M12*1.5		08	M 12x1.5	6.0	17.0	29.0	10.0	12.0	25.0	17	17	500	315
00TOe-L10-M12*1.5		10	M 12x1.5	6.0	17.0	30.0	11.0	12.0	26.0	17	19	315	315
00TOe-L10-M14*1.5		10	M 14x1.5	7.0	19.0	30.0	11.0	12.0	26.0	19	19	500	315
00TOe-L10-M16*1.5		10	M 16x1.5	8.0	22.0	31.5	12.5	12.0	24.0	22	19	420	315
00TOe-L10-M18*1.5		10	M 18x1.5	8.0	24.0	31.5	12.5	12.0	27.0	24	19	400	315
00TOe-L10-M22*1.5		10	M 22x1.5	8.0	27.0	35.0	14.0	14.0	29.0	27	19	400	315
00TOe-L12-M14*1.5		12	M 14x1.5	7.0	19.0	30.0	11.0	12.0	26.0	19	22	400	315
00TOe-L12-M16*1.5		12	M 16x1.5	9.0	22.0	31.5	12.5	12.0	27.0	22	22	400	315
00TOe-L12-M18*1.5		12	M 18x1.5	10.0	24.0	31.5	12.5	12.0	27.0	24	22	400	315
00TOe-L12-M22*1.5		12	M 22x1.5	10.0	27.0	35.0	14.0	14.0	29.0	27	22	400	315
00TOe-L15-M16*1.5		15	M 16x1.5	9.0	22.0	32.0	13.0	12.0	28.0	24	27	400	315
00TOe-L15-M18*1.5		15	M 18x1.5	11.0	24.0	32.5	13.5	12.0	29.0	24	27	400	315
00TOe-L15-M22*1.5		15	M 22x1.5	12.0	27.0	36.0	15.0	14.0	30.0	27	27	400	315
00TOe-L18-M18*1.5		18	M 18x1.5	11.0	24.0	33.5	14.0	12.0	30.0	27	32	400	315
00TOe-L18-M22*1.5		18	M 22x1.5	14.0	27.0	36.0	14.5	14.0	31.0	27	32	400	315
00TOe-L22-M22*1.5		22	M 22x1.5	14.0	32.0	38.0	16.5	14.0	33.0	32	36	250	160
00TOe-L22-M26*1.5		22	M 26x1.5	18.0	32.0	40.0	16.5	16.0	33.0	32	36	250	160
00TOe-L28-M33*2.0		28	M 33x2.0	23.0	40.0	43.0	17.5	18.0	34.0	41	41	250	160
00TOe-L35-M42*2.0		35	M 42x2.0	30.0	50.0	48.0	17.5	20.0	39.0	50	50	250	160
00TOe-L42-M48*2.0	42	M 48x2.0	36.0	55.0	52.0	19.0	22.0	42.0	55	60	250	160	
00TOf-S06-M12*1.5	S	06	M 12x1.5	4.0	17.0	32.0	13.0	12.0	28.0	17	17	800	630
00TOf-S08-M14*1.5		08	M 14x1.5	5.0	19.0	34.0	15.0	12.0	30.0	19	19	800	630
00TOf-S10-M16*1.5		10	M 16x1.5	7.0	22.0	34.5	15.0	12.0	31.0	22	22	800	630
00TOf-S12-M14*1.5		12	M 14x1.5	5.0	19.0	36.0	16.5	12.0	33.0	22	24	630	630
00TOf-S12-M18*1.5		12	M 18x1.5	8.0	24.0	36.5	17.0	12.0	33.0	24	24	630	630
00TOf-S12-M22*1.5		12	M 22x1.5	8.0	27.0	39.0	17.5	14.0	34.0	27	24	630	400
00TOf-S16-M22*1.5		16	M 22x1.5	12.0	27.0	41.0	18.5	14.0	37.0	27	30	630	400
00TOf-S16-M18*1.5		16	M 18x1.5	8.0	24.0	38.5	18.0	12.0	36.0	27	30	630	400
00TOf-S20-M27*2.0		20	M 27x2.0	16.0	32.0	47.0	20.5	16.0	42.0	32	36	420	400
00TOf-S25-M33*2.0		25	M 33x2.0	20.0	40.0	53.0	23.0	18.0	47.0	41	46	420	400
00TOf-S30-M42*2.0		30	M 42x2.0	25.0	50.0	57.0	23.5	20.0	50.0	50	50	420	400
00TOf-S38-M48*2.0		38	M 48x2.0	32.0	55.0	64.0	26.0	22.0	57.0	55	60	420	315

订货示例:

碳钢, 无六价铬镀锌: 00TOe-L06-M10x1.0

304不锈钢: 00TOe-L06-M10x1.0-304

316不锈钢: 00TOe-L06-M10x1.0-316

注: 订货号不含螺母卡套

注: 订货号含螺母卡套 00TOe-L06-M10x1.0-NBR

00TOg/00TOh 端直通接头—英制螺纹ED型密封

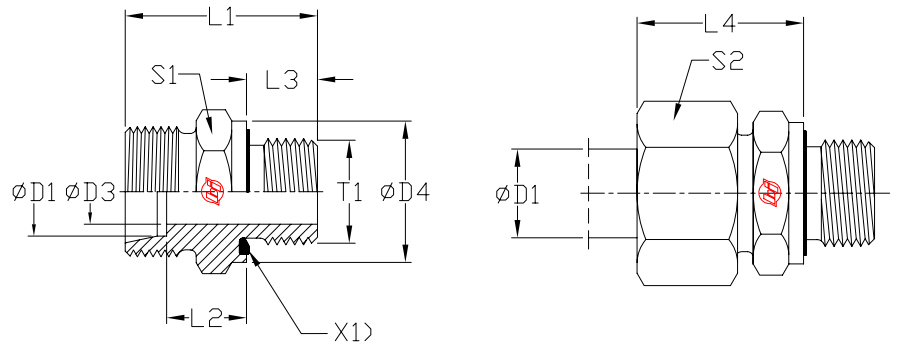

X1) ED 圈

订货号	系列	钢管 外径											PN(bar)	
		D1	T1	D3	D4	L1	L2	L3	L4	S1	S2	C	SS	
00TOg-L06-02	L	06	G1/8A	4.0	14.0	23.5	8.5	8.0	23.0	14	14	500	315	
00TOg-L06-04		06	G1/4A	4.0	19.0	29.0	10.0	12.0	25.0	19	14	500	315	
00TOg-L06-06		06	G3/8A	4.0	22.0	30.5	11.5	12.0	26.0	22	14	420	315	
00TOg-L06-08		06	G1/2A	4.0	27.0	33.0	12.0	14.0	27.0	27	14	400	315	
00TOg-L08-02		08	G1/8A	4.0	14.0	24.5	9.5	8.0	24.0	14	17	500	315	
00TOg-L08-04		08	G1/4A	6.0	19.0	29.0	10.0	12.0	25.0	19	17	500	315	
00TOg-L08-06		08	G3/8A	6.0	22.0	30.5	11.5	12.0	26.0	22	17	420	315	
00TOg-L08-08		08	G1/2A	6.0	27.0	33.0	12.0	14.0	27.0	27	17	400	315	
00TOg-L10-02		10	G1/8A	4.0	14.0	25.5	10.5	8.0	25.0	17	19	500	315	
00TOg-L10-04		10	G1/4A	6.0	19.0	30.0	11.0	12.0	26.0	19	19	500	315	
00TOg-L10-06		10	G3/8A	8.0	22.0	31.5	12.5	12.0	27.0	22	19	420	315	
00TOg-L10-08		10	G1/2A	8.0	27.0	34.0	13.0	14.0	28.0	27	19	400	315	
00TOg-L12-02		12	G1/8A	4.0	14.0	26.5	11.5	8.0	26.0	19	22	420	315	
00TOg-L12-04		12	G1/4A	6.0	19.0	31.0	12.0	12.0	27.0	19	22	400	315	
00TOg-L12-06		12	G3/8A	9.0	22.0	31.5	12.5	12.0	27.0	22	22	420	315	
00TOg-L12-08		12	G1/2A	10.0	27.0	34.0	13.0	14.0	28.0	27	22	400	315	
00TOg-L12-12		12	G3/4A	10.0	32.0	37.0	14.0	16.0	29.0	32	22	250	160	
00TOg-L15-06		15	G3/8A	9.0	22.0	32.5	13.5	12.0	29.0	24	27	400	315	
00TOg-L15-08		15	G1/2A	11.0	27.0	35.0	14.0	14.0	29.0	27	27	400	315	
00TOg-L15-12		15	G3/4A	12.0	32.0	38.0	15.0	16.0	30.0	32	27	250	160	
00TOg-L18-06		18	G3/8A	9.0	22.0	33.5	14.0	12.0	30.0	27	32	400	315	
00TOg-L18-08		18	G1/2A	14.0	27.0	36.0	14.5	14.0	31.0	27	32	400	315	
00TOg-L18-12		18	G3/4A	15.0	32.0	38.0	14.5	16.0	31.0	32	32	250	160	
00TOg-L22-08		22	G1/2A	14.0	27.0	38.0	16.5	14.0	33.0	32	36	250	160	
00TOg-L22-12		22	G3/4A	18.0	32.0	40.0	16.5	16.0	33.0	32	36	250	160	
00TOg-L22-16		22	G1 A	19.0	40.0	43.0	17.5	18.0	34.0	41	36	250	160	
00TOg-L28-12		28	G3/4A	18.0	32.0	41.0	17.5	16.0	34.0	41	41	250	160	
00TOg-L28-16		28	G1 A	23.0	40.0	43.0	17.5	18.0	34.0	41	41	250	160	
00TOg-L28-20	28	G1 1/4A	24.0	50.0	46.0	18.5	20.0	35.0	50	41	250	160		

00TOg/00TOh 端直通接头—英制螺纹ED型密封

续上表

订货号	系列	钢管 外径	T1	D3	D4	L1	L2	L3	L4	S1	S2	PN(bar)	
		D1										C	SS
00TOg-L35-16	L	35	G1 A	23.0	40.0	46.0	17.5	18.0	39.0	46	50	250	160
00TOg-L35-20		35	G1 1/4 A	30.0	50.0	48.0	17.5	20.0	39.0	50	50	250	160
00TOg-L35-24		35	G1 1/2 A	30.0	55.0	52.0	19.5	22.0	41.0	55	50	250	160
00TOg-L42-16		42	G1 A	23.0	40.0	48.0	19.0	18.0	42.0	55	60	250	160
00TOg-L42-20		42	G1 1/4A	30.0	50.0	50.0	19.0	20.0	42.0	55	60	250	160
00TOg-L42-24		42	G1 1/2A	36.0	55.0	52.0	19.0	22.0	42.0	55	60	250	160
00TOh-S06-02	S	06	G1/8A	4.0	14.0	27.5	12.5	8.0	27.0	14	17	500	315
00TOh-S06-04		06	G1/4A	4.0	19.0	32.0	13.0	12.0	28.0	19	17	800	630
00TOh-S06-06		06	G3/8A	4.0	22.0	34.5	15.5	12.0	30.0	22	17	630	630
00TOh-S06-08		06	G1/2A	4.0	27.0	39.0	18.0	14.0	33.0	27	17	630	400
00TOh-S08-04		08	G1/4A	5.0	19.0	34.0	15.0	12.0	30.0	19	19	800	630
00TOh-S08-06		08	G3/8A	5.0	22.0	34.5	15.5	12.0	30.0	22	19	800	630
00TOh-S08-08		08	G1/2A	5.0	27.0	39.0	18.0	14.0	33.0	27	19	630	400
00TOh-S10-04		10	G1/4A	5.0	19.0	34.0	14.5	12.0	31.0	19	22	800	630
00TOh-S10-06		10	G3/8A	7.0	22.0	34.5	15.0	12.0	31.0	22	22	800	630
00TOh-S10-08		10	G1/2A	7.0	27.0	39.0	17.5	14.0	34.0	27	22	630	630
00TOh-S12-04		12	G1/4A	5.0	19.0	36.0	16.5	12.0	33.0	22	24	630	630
00TOh-S12-06		12	G3/8A	8.0	22.0	36.5	17.0	12.0	33.0	22	24	630	630
00TOh-S12-08		12	G1/2A	8.0	27.0	39.0	17.5	14.0	34.0	27	24	630	630
00TOh-S16-08		16	G1/2A	12.0	27.0	41.0	18.5	14.0	37.0	27	30	630	400
00TOh-S16-06		16	G3/8A	8.0	22.0	38.5	18.0	12.0	36.0	27	30	630	400
00TOh-S16-12		16	G3/4A	12.0	32.0	45.0	20.5	16.0	39.0	32	30	420	400
00TOh-S20-08		20	G1/2A	12.0	27.0	45.0	20.5	14.0	42.0	32	36	420	400
00TOh-S20-12		20	G3/4A	16.0	32.0	47.0	20.5	16.0	42.0	32	36	420	400
00TOh-S20-16		20	G1 A	16.0	40.0	51.0	22.5	18.0	44.0	41	36	420	400
00TOh-S20-20		20	G1 1/4 A	16.0	50.0	53.0	22.5	20.0	44.0	50	36	420	400
00TOh-S25-08		25	G1/2A	12.0	27.0	49.0	23.0	14.0	47.0	41	46	420	400
00TOh-S25-12		25	G3/4A	16.0	32.0	51.0	23.0	16.0	47.0	41	46	420	400
00TOh-S25-16		25	G1 A	20.0	40.0	53.0	23.0	18.0	47.0	41	46	420	400
00TOh-S25-20		25	G1 1/4 A	20.0	50.0	55.0	23.0	20.0	47.0	50	46	420	400
00TOh-S25-24		25	G1 1/2 A	20.0	55.0	60.0	26.0	22.0	50.0	55	46	315	315
00TOh-S30-16		30	G1 A	20.0	40.0	55.0	23.5	18.0	50.0	46	50	420	400
00TOh-S30-20		30	G1 1/4 A	25.0	50.0	57.0	23.5	20.0	50.0	50	50	420	400
00TOh-S30-24		30	G1 1/2 A	25.0	55.0	62.0	26.5	22.0	53.0	55	50	315	315
00TOh-S38-20		38	G1 1/4 A	25.0	50.0	62.0	26.0	20.0	57.0	55	60	420	315
00TOh-S38-24		38	G1 1/2A	32.0	55.0	64.0	26.0	22.0	57.0	55	60	420	315

订货示例:

碳钢, 无六价铬镀锌: 00TOg-L06-02

304不锈钢: 00TOg-L06-02-304

316不锈钢: 00TOg-L06-02-316

注: 订货号不含螺母卡套

注: 订货号含螺母卡套 00TOg-L06-02-NBR

00TLm/00TLn 端直通接头—公制螺纹金属面密封

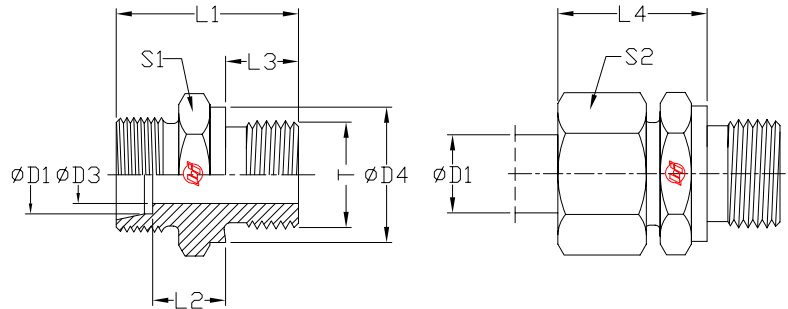

订货号	系列											PN(bar)	
		钢管 外径 D1	T	D3	D4	L1	L2	L3	L4	S1	S2	C	SS
00TLm-L06-M10*1.0	L	06	M10x1.0	4.0	14.0	23.5	8.5	8.0	23.0	14	14	315	315
00TLm-L08-M12*1.5		08	M12x1.5	6.0	17.0	29.0	10.0	12.0	25.0	17	17	315	315
00TLm-L10-M10*1.0		10	M10x1.0	4.0	14.0	25.5	10.5	8.0	25.0	17	19	315	315
00TLm-L10-M12*1.5		10	M12x1.5	6.0	17.0	30.0	11.0	12.0	26.0	17	19	315	315
00TLm-L10-M14*1.5		10	M14x1.5	7.0	19.0	30.0	11.0	12.0	26.0	19	19	315	315
00TLm-L10-M16*1.5		10	M16x1.5	8.0	21.0	31.5	12.0	12.0	27.0	22	19	315	315
00TLm-L10-M18*1.5		10	M18x1.5	8.0	23.0	31.5	12.5	12.0	27.0	24	19	315	315
00TLm-L10-M22*1.5		10	M22x1.5	8.0	27.0	35.0	14.0	14.0	29.0	27	19	315	315
00TLm-L12-M14*1.5		12	M14x1.5	7.0	19.0	30.0	11.0	12.0	26.0	19	22	315	315
00TLm-L12-M16*1.5		12	M16x1.5	9.0	21.0	31.5	12.5	12.0	27.0	22	22	315	315
00TLm-L12-M18*1.5		12	M18x1.5	10.0	23.0	31.5	12.5	12.0	27.0	24	22	315	315
00TLm-L12-M22*1.5		12	M22x1.5	10.0	27.0	35.0	14.0	14.0	29.0	27	22	315	315
00TLm-L15-M16*1.5		15	M16x1.5	9.0	21.0	32.0	13.0	12.0	28.0	24	27	250	250
00TLm-L15-M18*1.5		15	M18x1.5	11.0	23.0	32.5	13.5	12.0	29.0	24	27	250	250
00TLm-L15-M22*1.5		15	M22x1.5	12.0	27.0	36.0	15.0	14.0	30.0	27	27	250	250
00TLm-L18-M18*1.5		18	M18x1.5	11.0	23.0	33.5	14.0	12.0	30.0	27	32	250	250
00TLm-L18-M22*1.5		18	M22x1.5	14.0	27.0	36.0	14.5	14.0	31.0	27	32	250	250
00TLm-L22-M22*1.5		22	M22x1.5	14.0	27.0	38.0	16.5	14.0	33.0	32	36	160	160
00TLm-L22-M26*1.5		22	M26x1.5	18.0	31.0	40.0	16.5	16.0	33.0	32	36	160	160
00TLm-L28-M33*2.0		28	M33x2.0	23.0	39.0	43.0	17.5	18.0	34.0	41	41	160	160
00TLm-L35-M42*2.0	35	M42x2.0	30.0	49.0	48.0	17.5	20.0	39.0	50	50	160	160	
00TLm-L42-M48*2.0	42	M48x2.0	36.0	55.0	52.0	19.0	22.0	42.0	55	60	160	160	
00TLn-S06-M12*1.5	S	06	M12x1.5	4.0	17.0	32.0	13.0	12.0	28.0	17	17	400	400
00TLn-S06-M14*1.5		06	M14x1.5	4.0	19.0	34.0	15.0	12.0	30.0	19	17	400	400
00TLn-S08-M14*1.5		08	M14x1.5	5.0	19.0	34.0	15.0	12.0	30.0	19	19	400	400
00TLn-S10-M16*1.5		10	M16x1.5	7.0	21.0	34.5	15.0	12.0	31.0	22	22	400	400
00TLn-S12-M14*1.5		12	M14x1.5	5.0	19.0	36.0	16.5	12.0	33.0	22	24	400	400
00TLn-S12-M18*1.5		12	M18x1.5	8.0	23.0	36.5	17.0	12.0	33.0	24	24	400	400
00TLn-S12-M22*1.5		12	M22x1.5	8.0	27.0	39.0	17.5	14.0	34.0	27	24	400	400
00TLn-S14-M20*1.5		14	M20x1.5	10.0	25.0	41.0	19.0	14.0	37.0	27	27	400	400
00TLn-S16-M18*1.5		16	M18x1.5	8.0	23.0	38.5	18.0	12.0	36.0	27	30	400	400
00TLn-S16-M22*1.5		16	M22x1.5	12.0	27.0	41.0	18.5	14.0	37.0	27	30	400	400
00TLn-S20-M27*2.0		20	M27x2.0	16.0	32.0	47.0	20.5	16.0	42.0	32	36	400	400
00TLn-S25-M33*2.0		25	M33x2.0	20.0	39.0	53.0	23.0	18.0	47.0	41	46	250	250
00TLn-S30-M42*2.0		30	M42x2.0	25.0	49.0	57.0	23.5	20.0	50.0	50	50	160	160
00TLn-S38-M48*2.0		38	M48x2.0	32.0	55.0	64.0	26.0	22.0	57.0	55	60	160	160

订货示例:

碳钢, 无六价铬镀锌: 00TLm-L06-M10x1.0

304不锈钢: 00TLm-L06-M10x1.0-304

316不锈钢: 00TLm-L06-M10x1.0-316

注: 订货号不含螺母卡套

注: 订货号含螺母卡套 00TLm-L06-M10x1.0-NBR

00TLb/00TLc 端直通接头—英制螺纹金属面密封

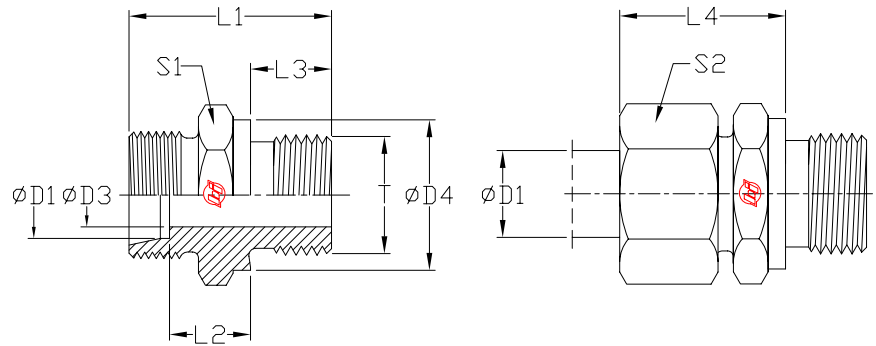

订货号	系列	钢管外径										PN(bar)	
		D1	T	D3	D4	L1	L2	L3	L4	S1	S2	C	SS
00TLb-L06-02	L	06	G1/8A	4.0	14.0	23.5	8.5	8.0	23.0	14	14	315	315
00TLb-L06-04		06	G1/4A	4.0	18.0	29.0	10.0	12.0	25.0	19	14	315	315
00TLb-L06-06		06	G3/8A	4.0	22.0	30.5	11.5	12.0	26.0	22	14	315	315
00TLb-L06-08		06	G1/2A	4.0	26.0	33.0	12.0	14.0	27.0	27	14	315	315
00TLb-L08-02		08	G1/8A	4.0	14.0	24.5	8.5	8.0	23.0	14	17	315	315
00TLb-L08-04		08	G1/4A	6.0	18.0	29.0	10.0	12.0	25.0	19	17	315	315
00TLb-L08-06		08	G3/8A	6.0	22.0	30.5	11.5	12.0	26.0	22	17	315	315
00TLb-L08-08		08	G1/2A	6.0	26.0	33.0	12.0	14.0	27.0	27	17	315	315
00TLb-L10-02		10	G1/8A	4.0	14.0	25.5	10.5	8.0	25.0	17	19	315	315
00TLb-L10-04		10	G1/4A	6.0	18.0	30.0	11.0	12.0	26.0	19	19	315	315
00TLb-L10-06		10	G3/8A	8.0	22.0	31.5	12.5	12.0	27.0	22	19	315	315
00TLb-L10-08		10	G1/2A	8.0	26.0	34.0	13.0	14.0	28.0	27	19	315	315
00TLb-L12-02		12	G1/8A	4.0	14.0	26.5	11.5	8.0	26.0	19	22	315	315
00TLb-L12-04		12	G1/4A	6.0	18.0	31.0	12.0	12.0	27.0	19	22	315	315
00TLb-L12-06		12	G3/8A	9.0	22.0	31.5	12.5	12.0	27.0	22	22	315	315
00TLb-L12-08		12	G1/2A	10.0	26.0	34.0	13.0	14.0	28.0	27	22	315	315
00TLb-L12-12		12	G3/4A	10.0	32.0	37.0	14.0	16.0	29.0	32	22	315	315
00TLb-L15-06		15	G3/8A	9.0	22.0	32.5	13.5	12.0	29.0	24	27	250	250
00TLb-L15-08		15	G1/2A	11.0	26.0	35.0	14.0	14.0	29.0	27	27	250	250
00TLb-L15-12		15	G3/4A	12.0	32.0	38.0	15.0	16.0	30.0	32	27	250	250
00TLb-L18-06		18	G3/8A	9.0	22.0	33.5	14.0	12.0	29.5	27	32	250	250
00TLb-L18-08		18	G1/2A	14.0	26.0	36.0	14.5	14.0	31.0	27	32	250	250
00TLb-L18-12		18	G3/4A	15.0	32.0	38.0	14.5	16.0	30.0	32	32	250	250
00TLb-L22-08		22	G1/2A	14.0	26.0	38.0	16.5	14.0	33.0	32	36	160	160
00TLb-L22-12		22	G3/4A	18.0	32.0	40.0	16.5	16.0	33.0	32	36	160	160
00TLb-L22-16		22	G1A	19.0	39.0	43.0	17.5	18.0	33.5	41	36	160	160
00TLb-L28-08		28	G1/2A	14.0	26.0	39.0	17.5	14.0	34.0	41	41	160	160
00TLb-L28-12		28	G3/4A	18.0	32.0	41.0	17.5	16.0	34.0	41	41	160	160
00TLb-L28-16		28	G1A	23.0	39.0	43.0	17.5	18.0	34.0	41	41	160	160
00TLb-L28-20		28	G1 1/4A	24.0	50.0	46.0	18.3	20.0	35.0	50	41	160	160
00TLb-L35-08		35	G1/2A	14.0	26.0	42.0	17.5	14.0	39.0	46	50	160	160
00TLb-L35-12		35	G3/4A	18.0	32.0	44.0	17.5	16.0	39.0	46	50	160	160
00TLb-L35-16		35	G1A	23.0	39.0	46.0	17.5	18.0	39.0	46	50	160	160
00TLb-L35-20		35	G1 1/4A	30.0	49.0	48.0	17.5	20.0	39.0	50	50	160	160
00TLb-L35-24		35	G1 1/2A	30.0	55.0	52.0	19.5	22.0	41.0	55	50	160	160
00TLb-L42-16		42	G1A	23.0	39.0	48.0	19.0	18.0	42.0	55	60	160	160
00TLb-L42-20		42	G1 1/4A	30.0	49.0	50.0	19.0	20.0	42.0	55	60	160	160
00TLb-L42-24		42	G1 1/2A	36.0	55.0	52.0	19.0	22.0	42.0	55	60	160	160

00TLb/00TLc 端直通接头—英制螺纹金属面密封

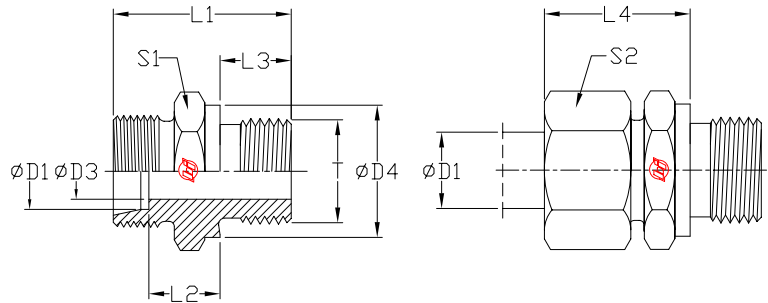

续上表

订货号	系列	钢管外径		D3	D4	L1	L2	L3	L4	S1	S2	PN(bar)	
		D1	T									C	SS
00TLc-S06-02	S	06	G1/8A	3.0	14.0	27.5	12.5	8.0	27	14	17	400	400
00TLc-S06-04		06	G1/4A	4.0	18.0	32.0	13.0	12.0	28	19	17	400	400
00TLc-S06-06		06	G3/8A	4.0	22.0	34.5	15.5	12.0	30	22	17	400	400
00TLc-S06-08		06	G1/2A	4.0	26.0	39.0	18.0	14.0	33	27	17	400	400
00TLc-S08-04		08	G1/4A	5.0	18.0	34.0	15.0	12.0	30	19	19	400	400
00TLc-S08-06		08	G3/8A	5.0	22.0	34.5	15.5	12.0	30	22	19	400	400
00TLc-S08-08		08	G1/2A	5.0	26.0	39.0	18.0	14.0	33	27	19	400	400
00TLc-S10-04		10	G1/4A	5.0	18.0	34.0	14.5	12.0	31	19	22	400	400
00TLc-S10-06		10	G3/8A	7.0	22.0	34.5	15.0	12.0	31	22	22	400	400
00TLc-S10-08		10	G1/2A	7.0	26.0	39.0	17.5	14.0	34	27	22	400	400
00TLc-S12-04		12	G1/4A	5.0	18.0	36.0	16.5	12.0	33	22	24	400	400
00TLc-S12-06		12	G3/8A	8.0	22.0	36.5	17.0	12.0	33	22	24	400	400
00TLc-S12-08		12	G1/2A	8.0	26.0	39.0	17.5	14.0	34	27	24	400	400
00TLc-S14-06		14	G3/8A	8.0	22.0	38.5	18.5	12.0	36	24	27	400	400
00TLc-S14-08		14	G1/2A	10.0	26.0	41.0	19.0	14.0	37	27	27	400	400
00TLc-S16-06		16	G3/8A	8.0	22.0	38.5	18.0	12.0	36	27	30	400	400
00TLc-S16-08		16	G1/2A	12.0	26.0	41.0	18.5	14.0	37	27	30	400	400
00TLc-S16-12		16	G3/4A	12.0	32.0	45.0	20.5	16.0	39	32	30	400	400
00TLc-S20-08		20	G1/2A	12.0	26.0	45.0	20.5	14.0	42	32	36	400	400
00TLc-S20-12		20	G3/4A	16.0	32.0	47.0	20.5	16.0	42	32	36	400	400
00TLc-S20-16		20	G1A	16.0	39.0	51.0	22.5	18.0	44	41	36	250	250
00TLc-S20-20		20	G1 1/4A	16.0	49.0	53.0	22.5	20.0	44	50	36	160	160
00TLc-S25-12		25	G3/4A	16.0	32.0	51.0	23.0	16.0	47	41	46	250	250
00TLc-S25-16		25	G1A	20.0	39.0	53.0	23.0	18.0	47	41	46	250	250
00TLc-S25-20		25	G1 1/4A	20.0	49.0	55.0	23.0	20.0	47	50	46	160	160
00TLc-S30-16		30	G1A	20.0	39.0	55.0	23.5	18.0	50	46	50	160	160
00TLc-S30-20		30	G1 1/4A	25.0	49.0	57.0	23.5	20.0	50	50	50	160	160
00TLc-S38-20		38	G1 1/4A	25.0	49.0	62.0	26.0	20.0	57	55	60	160	160
00TLc-S38-24		38	G1 1/2 A	32.0	55.0	64.0	26.0	22.0	57	55	60	160	160

订货示例:

碳钢, 无六价铬镀锌: 00TLb-L06-02

304不锈钢: 00TLb-L06-02-304

316不锈钢: 00TLb-L06-02-316

注: 订货号不含螺母卡套

注: 订货号含螺母卡套 00TLb-L06-02-NBR

00TR 端直通过头—BSPT锥管螺纹

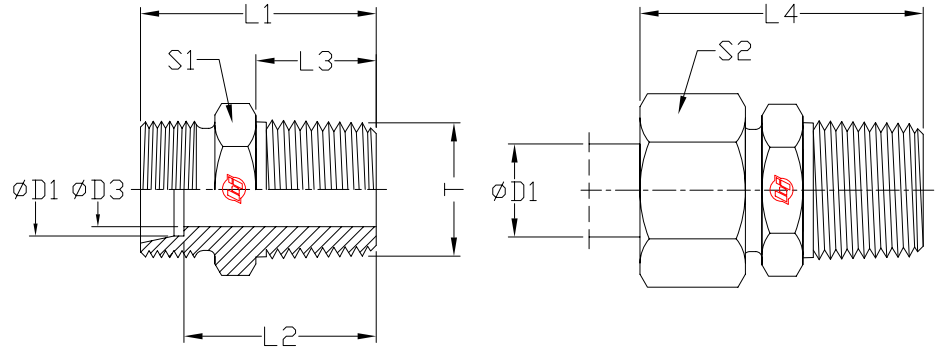

订货号	系列	钢管外径									PN(bar)	
		D1	T	D3	L1	L2	L3	L4	S1	S2	C	SS
00TR-L06-02	L	06	R1/8	4.0	22.0	15.0	8.0	30.0	12	14	315	315
00TR-L06-04		06	R1/4	4.0	27.0	20.0	12.0	35.0	17	14	315	315
00TR-L08-02		08	R1/8	4.0	23.0	16.0	8.0	31.0	17	17	315	315
00TR-L08-04		08	R1/4	6.0	27.0	20.0	12.0	35.0	17	17	315	315
00TR-L10-04		10	R1/4	7.0	28.0	21.0	12.0	36.0	17	19	315	315
00TR-L12-04		12	R1/4	7.0	29.0	22.0	12.0	37.0	19	22	315	315
00TR-L12-06		12	R 3/8	9.0	29.0	22.0	12.0	37.0	19	22	315	315
00TR-L12-08		12	R1/2	10.0	31.0	24.0	14.0	39.0	24	22	315	315
00TR-L15-06		15	R 3/8	9.0	30.0	23.0	12.0	38.0	24	27	315	315
00TR-L15-08		15	R1/2	11.0	32.0	25.0	14.0	40.0	24	27	315	315
00TR-L18-08		18	R 1/2	14.0	33.0	25.5	14.0	42.0	27	32	315	315
00TR-L22-12		22	R 3/4	17.0	37.0	29.5	16.0	46.0	32	36	160	160
00TR-L28-16		28	R 1	23.0	40.0	32.5	18.0	49.0	41	41	160	160
00TR-L35-20		35	R1 1/4	30.0	45.0	34.5	20.0	56.0	46	50	160	160
00TR-L42-24		42	R1 1/2	36.0	49.0	38.0	22.0	61.0	55	60	160	160

订货示例:

碳钢, 无六价铬镀锌: 00TR-L06-02

304不锈钢: 00TR-L06-02-304

316不锈钢: 00TR-L06-02-316

注: 订货号不含螺母卡套

注: 订货号含螺母卡套 00TR-L06-02-NBR

00TOj/00TOd 端直通接头—UNF螺纹O型圈密封

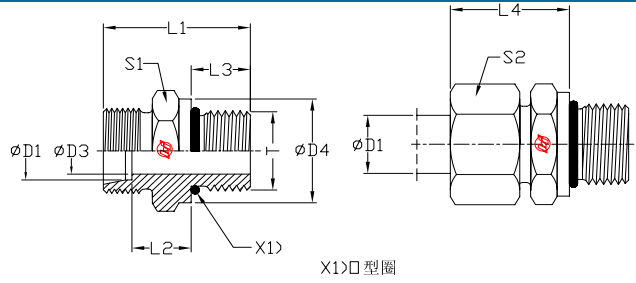

订货号	系列	钢管外径		D3	D4	L1	L2	L3	L4	S1	S2	PN(bar)	
		D1	T									C	SS
00TOj-L08-04	L	08	7/16-20UNF	5.0	—	26.0	10.0	9.0	25.0	17	17	315	315
00TOj-L10-04		10	7/16-20UNF	5.0	—	27.0	11.0	9.0	26.0	17	19	315	315
00TOj-L12-06		12	9/16-18UNF	7.0	—	28.0	11.0	10.0	26.0	19	22	315	315
00TOj-L12-08		12	3/4-16UNF	10.0	—	31.0	13.0	11.0	28.0	24	22	315	315
00TOj-L12-10		12	7/8-14UNF	10.0	—	34.0	14.3	12.7	29.0	27	22	315	315
00TOj-L15-08		15	3/4-16UNF	11.0	—	32.0	14.0	11.0	29.0	24	27	315	315
00TOj-L15-10		15	7/8-14UNF	12.0	—	35.0	15.3	12.7	30.0	27	27	315	315
00TOj-L18-08		18	3/4-16UNF	11.0	23.9	33.0	14.5	11.0	31.0	27	32	315	315
00TOj-L18-10		18	7/8-14UNF	14.0	—	35.0	14.8	12.7	31.0	27	32	315	315
00TOj-L22-10		22	7/8-14UNF	14.0	26.9	37.0	16.8	12.7	33.0	32	36	160	160
00TOj-L22-12		22	1 1/16-12UN	18.0	—	39.0	16.5	15.0	33.0	32	36	160	160
00TOj-L22-16		22	1 5/16-12UN	19.0	—	40.0	17.5	15.0	34.0	41	36	160	160
00TOj-L28-12		28	1 1/16-12UN	18.0	33.3	40.0	17.5	15.0	34.0	41	41	160	160
00TOj-L28-16		28	1 5/16-12UN	23.0	—	40.0	17.5	15.0	34.0	41	41	160	160
00TOj-L35-16		35	1 5/16-12UN	23.0	39.6	43.0	17.5	15.0	39.0	46	50	160	160
00TOj-L35-20		35	1 5/8-12UN	29.0	—	43.0	17.5	15.0	39.0	50	50	160	160
00TOj-L42-20		42	1 5/8-12UN	29.0	47.7	45.0	19.0	15.0	42.0	55	60	160	160
00TOd-S08-04		S	08	7/16-20UNF	4.0	—	31.0	13.0	11.0	30.0	17	19	630
00TOd-S10-06	10		9/16-18UNF	6.0	—	32.0	12.5	12.0	31.0	19	22	630	630
00TOd-S12-06	12		9/16-18UNF	6.0	19.0	32.0	12.5	12.0	31.0	22	24	630	630
00TOd-S12-08	12		3/4-16UNF	8.0	—	36.0	14.5	14.0	34.0	24	24	630	630
00TOd-S16-08	16		3/4-16UNF	10.0	—	35.0	12.5	14.0	34.0	24	30	400	400
00TOd-S16-10	16		7/8-14UNF	12.0	—	40.0	15.5	16.0	37.0	27	30	400	400
00TOd-S20-08	20		3/4-16UNF	10.0	23.9	42.0	17.5	14.0	42.0	32	36	400	400
00TOd-S20-10	20		7/8-14UNF	12.0	26.9	44.0	17.5	16.0	42.0	32	36	400	400
00TOd-S20-12	20		1 1/16-12UN	16.0	—	46.0	17.0	18.5	42.0	32	36	400	400
00TOd-S25-12	25		1 1/16-12UN	16.0	33.3	50.0	19.5	18.5	47.0	36	46	400	400
00TOd-S25-16	25		1 5/16-12UN	20.0	—	50.0	19.5	18.5	47.0	41	46	400	400
00TOd-S30-16	30		1 5/16-12UN	20.0	39.6	52.0	20.0	18.5	50.0	46	50	400	400
00TOd-S30-20	30		1 5/8-12UN	24.0	—	52.0	20.0	18.5	50.0	50	50	400	400
00TOd-S38-20	38		1 5/8-12UN	24.0	47.7	57.0	22.5	18.5	57.0	55	60	315	315

订货示例:

碳钢, 无六价铬镀锌: 00TOj-L08-04

304不锈钢: 00TOj-L08-04-304

316不锈钢: 00TOj-L08-04-316

注: 订货号不含螺母卡套

注: 订货号含螺母卡套 00TOj-L08-04-NBR

00TP 端直通接头—NPT锥管螺纹

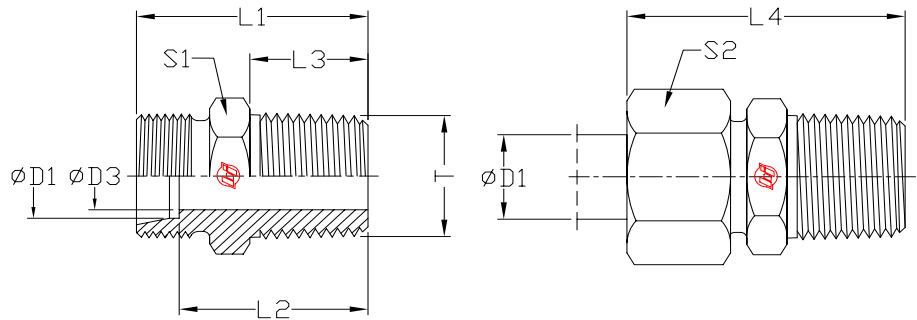

订货号	系列	钢管外径		D3	L1	L2	L3	L4	S1	S2	PN(bar)	
		D1	T								C	SS
00TP-L06-02	L	06	1/8-27 NPT	4.0	24.0	17.0	10.0	32.0	12	14	315	315
00TP-L06-04		06	1/4-18 NPT	4.0	30.0	23.0	14.5	38.0	17	14	315	315
00TP-L06-06		06	3/8-18 NPT	4.0	30.0	23.0	14.5	38.0	19	14	315	315
00TP-L06-08		06	1/2-14 NPT	4.0	36.0	29.0	19.5	44.0	22	14	315	315
00TP-L08-02		08	1/8-27 NPT	4.0	25.0	18.0	10.0	33.0	14	17	315	315
00TP-L08-04		08	1/4-18 NPT	6.0	30.0	23.0	14.5	38.0	17	17	315	315
00TP-L08-06		08	3/8-18 NPT	6.0	30.0	23.0	14.5	38.0	19	17	315	315
00TP-L08-08		08	1/2-14 NPT	6.0	36.0	29.0	19.5	44.0	22	17	315	315
00TP-L10-02		10	1/8-27 NPT	4.0	25.0	18.0	10.0	33.0	17	19	315	315
00TP-L10-04		10	1/4-18 NPT	7.0	31.0	24.0	14.5	39.0	17	19	315	315
00TP-L10-06		10	3/8-18 NPT	7.0	32.0	25.0	14.5	40.0	19	19	315	315
00TP-L10-08		10	1/2-14 NPT	8.0	37.0	30.0	19.5	45.0	22	19	315	315
00TP-L10-12		10	3/4-14 NPT	8.0	38.0	31.0	19.5	46.0	30	19	315	315
00TP-L12-02		12	1/8-27 NPT	4.0	26.0	19.0	10.0	34.0	19	22	315	315
00TP-L12-04		12	1/4-18 NPT	7.0	32.0	25.0	14.5	40.0	19	22	315	315
00TP-L12-06		12	3/8-18 NPT	8.0	32.0	25.0	14.5	40.0	19	22	315	315
00TP-L12-08		12	1/2-14 NPT	10.0	37.0	30.0	19.5	45.0	22	22	315	315
00TP-L15-06		15	3/8-18 NPT	8.0	33.0	26.0	14.5	41.0	24	27	315	315
00TP-L15-08		15	1/2-14 NPT	12.0	38.0	31.0	19.5	46.0	24	27	315	315
00TP-L15-12		15	3/4-14 NPT	12.0	39.0	32.0	19.5	47.0	30	27	315	315
00TP-L15-16		15	1-11.5 NPT	12.0	45.0	38.0	24.5	53.0	36	27	315	315
00TP-L18-06		18	3/8-18 NPT	8.0	34.0	26.5	14.5	43.0	27	32	315	315
00TP-L18-08		18	1/2-14 NPT	12.0	39.0	31.5	19.5	48.0	27	32	315	315
00TP-L18-12		18	3/4-14 NPT	15.0	39.0	31.5	19.5	48.0	30	32	315	315
00TP-L18-16		18	1-11.5 NPT	15.0	45.0	37.5	24.5	54.0	36	32	315	315
00TP-L22-06		22	3/8-18 NPT	8.0	36.5	29.0	14.5	45.0	32	36	160	160
00TP-L22-08		22	1/2-14 NPT	12.0	41.0	33.5	19.5	50.0	32	36	160	160
00TP-L22-12		22	3/4-14 NPT	16.0	41.0	33.5	19.5	50.0	32	36	160	160
00TP-L22-16		22	1-11.5 NPT	19.0	47.0	39.5	24.5	56.0	36	36	160	160
00TP-L28-12		28	3/4-14 NPT	16.0	42.0	34.5	19.5	51.0	41	41	160	160
00TP-L28-16		28	1-11.5 NPT	21.0	47.0	39.5	24.5	56.0	41	41	160	160
00TP-L28-20		28	1 1/4-11.5 NPT	24.0	49.0	41.5	25.0	58.0	46	41	160	160
00TP-L35-16		35	1-11.5 NPT	22.0	50.0	39.5	24.5	61.0	46	50	160	160
00TP-L35-20		35	1 1/4-11.5 NPT	28.0	51.0	40.5	25.0	62.0	46	50	160	160
00TP-L42-20		42	1 1/4-11.5 NPT	28.0	53.0	42.0	25.0	65.0	55	60	160	160
00TP-L42-24		42	1 1/2-11.5 NPT	36.0	53.0	42.0	26.0	65.0	55	60	160	160

00TP 端直通接头—NPT锥管螺纹

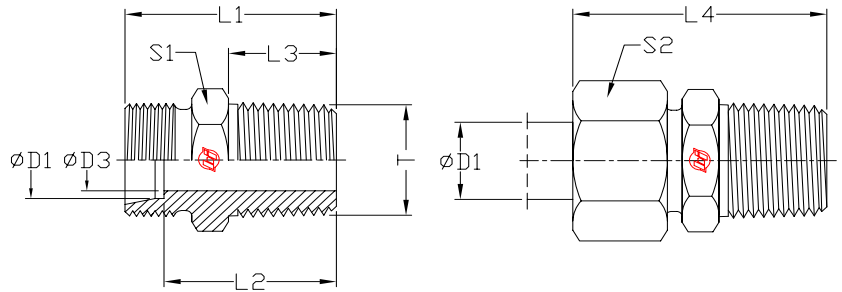

续上表

订货号	系列	钢管外径		T1	D3	L1	L2	L3	L4	S1	S2	PN(bar)	
		D1	C									SS	
00TP-S06-02	S	06	1/8-27 NPT	4.0	28.0	21.0	10.0	36.0	14	17	630	630	
00TP-S06-04		06	1/4-18 NPT	4.0	35.0	28.0	14.5	43.0	17	17	630	630	
00TP-S06-06		06	3/8-18 NPT	4.0	33.0	26.0	14.5	41.0	19	17	630	630	
00TP-S06-08		06	1/2-14 NPT	4.0	42.0	35.0	19.5	50.0	22	17	630	630	
00TP-S08-04		08	1/4-18 NPT	5.0	35.0	28.0	14.5	43.0	17	19	630	630	
00TP-S08-06		08	3/8-18 NPT	5.0	35.0	28.0	14.5	43.0	19	19	630	630	
00TP-S08-08		08	1/2-14 NPT	5.0	42.0	35.0	19.5	50.0	22	19	630	630	
00TP-S10-04		10	1/4-18 NPT	5.0	35.0	27.5	14.5	44.0	19	22	630	630	
00TP-S10-06		10	3/8-18 NPT	7.0	35.0	27.5	14.5	44.0	19	22	630	630	
00TP-S10-08		10	1/2-14 NPT	7.0	42.0	34.5	19.5	51.0	22	22	630	630	
00TP-S10-12		10	3/4-14 NPT	7.0	44.0	36.5	19.5	53.0	30	22	630	630	
00TP-S12-04		12	1/4-18 NPT	5.0	37.0	29.5	14.5	46.0	22	24	630	630	
00TP-S12-06		12	3/8-18 NPT	8.0	37.0	29.5	14.5	46.0	22	24	630	630	
00TP-S12-08		12	1/2-14 NPT	8.0	42.0	34.5	19.5	51.0	22	24	630	630	
00TP-S12-12		12	3/4-14 NPT	8.0	44.0	36.5	19.5	53.0	30	24	630	630	
00TP-S16-06		16	3/8-18 NPT	8.0	39.0	30.5	14.5	49.0	27	30	400	400	
00TP-S16-08		16	1/2-14 NPT	12.0	48.0	39.5	19.5	58.0	32	30	400	400	
00TP-S16-12		16	3/4-14 NPT	12.0	46.0	37.5	19.5	56.0	30	30	400	400	
00TP-S16-16		16	1-11.5 NPT	12.0	51.0	42.5	24.5	61.0	36	30	400	400	
00TP-S20-08		20	1/2-14 NPT	12.0	48.0	37.5	19.5	59.0	32	36	400	400	
00TP-S20-12		20	3/4-14 NPT	16.0	48.0	37.5	19.5	59.0	32	36	400	400	
00TP-S20-16		20	1-11.5 NPT	16.0	55.0	44.5	24.5	66.0	36	36	400	400	
00TP-S25-12		25	3/4-14 NPT	16.0	52.0	40.0	19.5	64.0	41	46	400	400	
00TP-S25-16		25	1-11.5 NPT	20.0	57.0	45.0	24.5	69.0	41	46	400	400	
00TP-S25-20		25	1 1/4-11.5 NPT	20.0	58.0	46.0	25.0	70.0	46	46	400	400	
00TP-S25-24		25	1 1/2-11.5 NPT	20.0	61.0	49.0	26.0	73.0	50	46	400	400	
00TP-S30-12		30	3/4-14 NPT	16.0	54.0	40.5	19.5	67.0	46	50	400	400	
00TP-S30-16		30	1-11.5 NPT	20.0	59.0	45.5	24.5	72.0	46	50	400	400	
00TP-S30-20		30	1 1/4-11.5 NPT	25.0	60.0	46.5	25.0	73.0	46	50	400	400	
00TP-S30-24		30	1 1/2-11.5 NPT	25.0	60.0	46.5	26.0	73.0	50	50	400	400	
00TP-S38-16		38	1-11.5 NPT	22.0	64.0	48.0	24.5	79.0	55	60	315	315	
00TP-S38-20		38	1 1/4-11.5 NPT	25.0	65.0	49.0	25.0	80.0	55	60	315	315	
00TP-S38-24	38	1 1/2-11.5 NPT	32.0	65.0	49.0	26.0	80.0	55	60	315	315		

订货示例:

碳钢, 无六价铬镀锌: 00TP-L06-02

304不锈钢: 00TP-L06-02-304

316不锈钢: 00TP-L06-02-316

注: 订货号不含螺母卡套

注: 订货号含螺母卡套 00TP-L06-02-NBR

00OeSr/00OfSr 端直通组合—公制螺纹ED型密封

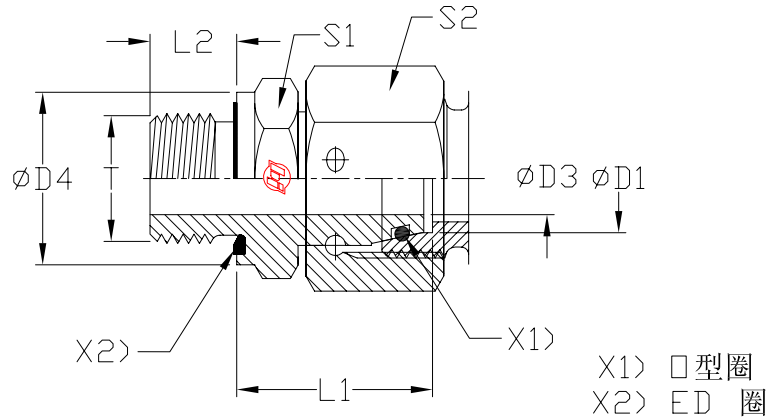

订货号	系列	钢管外径								PN(bar)	
		D1	T	D3	D4	L1	L2	S1	S2	C	SS
00OeSr-M10*1.0-L06	L	06	M 10x1.0	2.5	14.0	24.5	8.0	14	14	500	315
00OeSr-M12*1.5-L08		08	M 12x1.5	4.0	17.0	26.5	12.0	17	17	500	315
00OeSr-M14*1.5-L10		10	M 14x1.5	6.0	19.0	27.5	12.0	19	19	500	315
00OeSr-M16*1.5-L12		12	M 16x1.5	8.0	22.0	30.5	12.0	22	22	400	315
00OeSr-M22*1.5-L12		12	M 22x1.5	8.0	27.0	27.0	14.0	27	22	400	315
00OeSr-M18*1.5-L15		15	M 18x1.5	10.0	24.0	31.5	12.0	24	27	400	315
00OeSr-M22*1.5-L15		15	M 22x1.5	10.0	27.0	32.0	14.0	27	27	400	315
00OeSr-M22*1.5-L18		18	M 22x1.5	13.0	27.0	31.5	14.0	27	32	400	315
00OeSr-M26*1.5-L22		22	M 26x1.5	17.0	32.0	32.5	16.0	32	36	250	160
00OeSr-M33*2.0-L28		28	M 33x2.0	22.0	40.0	35.0	18.0	41	41	250	160
00OeSr-M42*2.0-L35		35	M 42x2.0	28.0	50.0	42.5	20.0	50	50	250	160
00OeSr-M48*2.0-L42		42	M 48x2.0	34.0	55.0	46.5	22.0	55	60	250	160
00OfSr-M12*1.5-S06	S	06	M 12x1.5	2.5	17.0	27.0	12.0	17	17	800	630
00OfSr-M14*1.5-S08		08	M 14x1.5	4.0	19.0	29.5	12.0	19	19	800	630
00OfSr-M16*1.5-S10		10	M 16x1.5	6.0	22.0	32.0	12.0	22	22	800	630
00OfSr-M18*1.5-S12		12	M 18x1.5	8.0	24.0	34.0	12.0	24	24	630	630
00OfSr-M20*1.5-S14		14	M 20x1.5	9.0	26.0	36.5	14.0	27	27	630	630
00OfSr-M22*1.5-S16		16	M 22x1.5	11.0	27.0	37.0	14.0	27	30	630	400
00OfSr-M27*2.0-S20		20	M 27x2.0	14.0	32.0	43.0	16.0	32	36	420	400
00OfSr-M33*2.0-S25		25	M 33x2.0	18.0	40.0	48.0	18.0	41	46	420	400
00OfSr-M42*2.0-S30		30	M 42x2.0	23.0	50.0	51.0	20.0	50	50	420	400
00OfSr-M48*2.0-S38		38	M 48x2.0	30.0	55.0	60.0	22.0	55	60	420	315

订货示例:

碳钢, 无六价铬镀锌: 00OeSr-M10x1.0-L06

304不锈钢: 00OeSr-M10x1.0-L06-304

316不锈钢: 00OeSr-M10x1.0-L06-316

注: 订货号不含螺母卡套

注: 订货号含螺母卡套 00OeSr-M10x1.0-L06-NBR

00OgSr/00OhSr 端直通组合—英制螺纹ED型密封

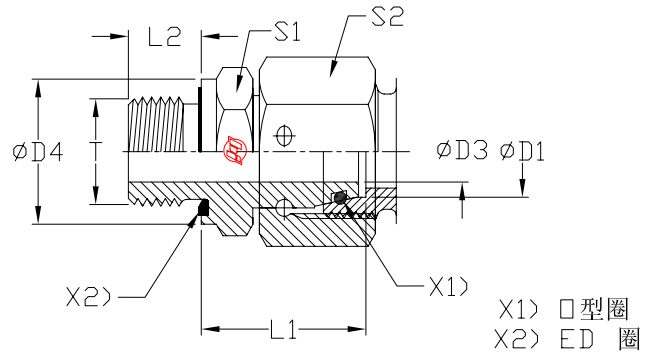

订货号	系列	钢管外径								PN(bar)	
		D1	T	D3	D4	L1	L2	S1	S2	C	SS
00OgSr-02-L06	L	06	G1/8A	2.5	14.0	24.5	8.0	14	14	500	315
00OgSr-04-L08		08	G1/4A	4.0	19.0	29.5	12.0	19	17	500	315
00OgSr-04-L10		10	G1/4A	6.0	19.0	27.5	12.0	19	19	500	315
00OgSr-06-L10		10	G3/8A	6.0	22.0	29.0	12.0	22	19	400	315
00OgSr-06-L12		12	G3/8A	8.0	22.0	34.0	12.0	22	22	400	315
00OgSr-04-L12		12	G1/4A	6.0	19.0	27.5	12.0	19	22	400	315
00OgSr-08-L12		12	G1/2A	8.0	27.0	29.5	14.0	27	22	400	315
00OgSr-08-L15		15	G1/2A	10.0	27.0	32.0	14.0	27	27	400	315
00OgSr-08-L18		18	G1/2A	13.0	27.0	31.5	14.0	27	32	400	315
00OgSr-12-L18		18	G3/4A	13.0	32.0	29.5	16.0	32	32	250	315
00OgSr-12-L22		22	G3/4A	17.0	32.0	32.5	16.0	32	36	250	160
00OgSr-16-L28		28	G1 A	22.0	40.0	35.0	18.0	41	41	250	160
00OgSr-20-L35		35	G1 1/4 A	28.0	50.0	42.5	20.0	50	50	250	160
00OgSr-24-L42		42	G1 1/2A	34.0	55.0	46.5	22.0	55	60	250	160
00OhSr-04-S06		S	06	G1/4A	2.5	19.0	27.0	12.0	19	17	800
00OhSr-04-S08	08		G1/4A	4.0	19.0	29.5	12.0	19	19	800	630
00OhSr-06-S10	10		G3/8A	6.0	22.0	32.0	12.0	22	22	800	630
00OhSr-06-S12	12		G3/8A	8.0	22.0	34.0	12.0	22	24	630	630
00OhSr-04-S12	12		G1/4A	5.0	19.0	31.5	12.0	19	24	630	630
00OhSr-08-S12	12		G1/2A	8.0	27.0	35.0	14.0	27	24	630	630
00OhSr-08-S14	14		G1/2A	9.0	27.0	36.5	14.0	27	27	630	630
00OhSr-08-S16	16		G1/2A	11.0	27.0	37.0	14.0	27	30	630	400
00OhSr-12-S20	20		G3/4A	14.0	32.0	43.0	16.0	32	36	420	400
00OhSr-16-S25	25		G1 A	18.0	40.0	48.0	18.0	41	46	420	400
00OhSr-20-S30	30		G1 1/4A	23.0	50.0	51.0	20.0	50	50	420	400
00OhSr-24-S38	38		G1 1/2A	30.0	55.0	60.0	22.0	55	60	420	315

订货示例:

碳钢, 无六价铬镀锌: 00OgSr-02-L06

304不锈钢: 00OgSr-02-L06-304

316不锈钢: 00OgSr-02-L06-316

注: 订货号不含螺母卡套

注: 订货号含螺母卡套 00OgSr-02-L06-NBR

00PSr 端直通组合—NPT锥管螺纹

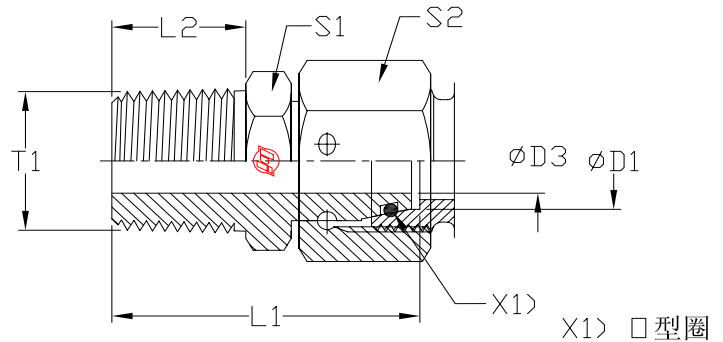

订货号	系列	钢管外径	T1	D3	L1	L2	S1	S2	PN(bar)	
		D1							C	SS
00PSr-02-L06	L	06	1/8-27NPT	2.5	31.5	10.0	11	14	315	315
00PSr-04-L08		08	1/4-18NPT	4.0	37.5	14.5	14	17	315	315
00PSr-04-L10		10	1/4-18NPT	6.0	38.0	14.5	14	19	315	315
00PSr-06-L12		12	3/8-18NPT	8.0	40.0	14.5	19	22	315	315
00PSr-08-L15		15	1/2-14NPT	10.0	49.5	19.5	22	27	315	315
00PSr-08-L18		18	1/2-14NPT	12.0	49.0	19.5	24	32	315	315
00PSr-12-L22		22	3/4-14NPT	16.0	52.0	19.5	27	36	160	160
00PSr-16-L28		28	1-11 1/2NPT	22.0	61.0	24.5	36	41	160	160
00PSr-20-L35		35	1 1/4-11 1/2NPT	28.0	65.5	25.0	46	50	160	160
00PSr-24-L42		42	1 1/2-11 1/2NPT	34.0	68.5	26.0	50	60	160	160
00PSr-04-S06	S	06	1/4-18NPT	2.5	37.5	14.5	14	17	630	630
00PSr-04-S08		08	1/4-18NPT	4.0	38.0	14.5	14	19	630	630
00PSr-06-S10		10	3/8-18NPT	6.0	40.5	14.5	19	22	630	630
00PSr-06-S12		12	3/8-18NPT	8.0	42.0	14.5	19	24	630	630
00PSr-08-S14		14	1/2-14NPT	9.0	50.5	19.5	22	27	630	630
00PSr-08-S16		16	1/2-14NPT	11.0	51.0	19.5	22	30	400	400
00PSr-12-S20		20	3/4-14NPT	14.0	54.0	19.5	27	36	400	400
00PSr-16-S25		25	1-11 1/2NPT	18.0	63.5	24.5	36	46	400	400
00PSr-20-S30		30	1 1/4-11 1/2NPT	23.0	70.5	25.0	46	50	400	400
00PSr-24-S38		38	1 1/2-11 1/2NPT	30.0	73.5	26.0	50	60	315	315

订货示例:

碳钢, 无六价铬镀锌:00PSr-02-L06

304不锈钢:00PSr-02-L06-304

316不锈钢:00PSr-02-L06-316

注:订货号不含螺母卡套

注:订货号含螺母卡套00PSr-02-L06-NBR

90TAs 端直角可调向接头—公制螺纹

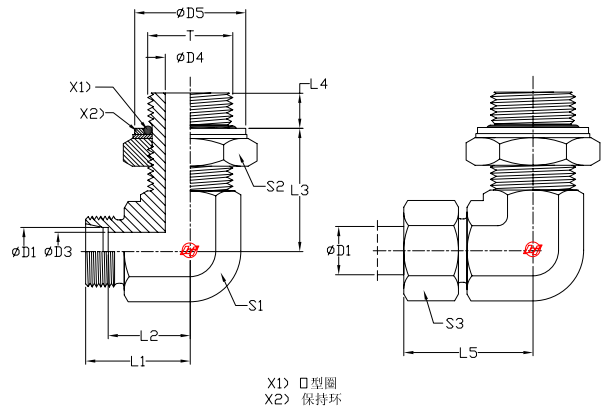

订货号	系列	钢管外径														PN(bar)	
		D1	T	D3	D4	D5	L1	L2	L3	L4	L5	S1	S2	S3	C	SS	
90TAs-L06-M10*1.0	L	06	M10x1.0	4.0	4.5	15.0	21.0	14.0	20.0	7.0	29.0	14	14	14	315	315	
90TAs-L08-M12*1.5		08	M12x1.5	6.0	6.0	18.0	23.0	16.0	22.0	10.0	31.0	14	17	17	315	315	
90TAs-L10-M14*1.5		10	M14x1.5	8.0	7.5	20.0	24.0	17.0	24.0	10.0	32.0	19	19	19	315	315	
90TAs-L12-M16*1.5		12	M16x1.5	10.0	9.0	23.0	26.0	19.0	25.0	10.0	34.0	19	22	22	315	315	
90TAs-L15-M18*1.5		15	M18x1.5	12.0	11.0	25.0	28.0	21.0	31.0	11.0	36.0	22	24	27	315	315	
90TAs-L18-M22*1.5		18	M22x1.5	15.0	14.0	28.0	31.0	24.0	33.0	12.0	40.0	27	27	32	250	250	
90TAs-L22-M27*2.0		22	M27x2.0	19.0	18.0	33.0	35.0	28.0	36.0	14.0	44.0	30	32	36	160	160	
90TAs-L28-M33*2.0		28	M33x2.0	24.0	23.0	41.0	38.0	31.0	39.0	14.0	47.0	36	41	41	160	160	
90TAs-L35-M42*2.0		35	M42x2.0	30.0	30.0	51.0	48.0	38.0	49.0	14.0	59.0	50	50	50	160	160	
90TAs-L42-M48*2.0		42	M48x2.0	36.0	36.0	56.0	49.0	38.0	50.0	16.0	61.0	50	55	60	160	160	
90TAs-S06-M12*1.5	S	06	M12x1.5	4.0	4.0	18.0	22.0	15.0	22.0	10.0	30.0	14	17	17	315	315	
90TAs-S08-M14*1.5		08	M14x1.5	5.0	6.0	20.0	24.0	17.0	26.0	10.0	32.0	19	19	19	315	315	
90TAs-S10-M16*1.5		10	M16x1.5	7.0	7.0	23.0	25.0	18.0	27.0	11.0	34.0	19	22	22	315	315	
90TAs-S12-M18*1.5		12	M18x1.5	8.0	9.0	25.0	29.0	22.0	31.0	12.0	38.0	22	24	24	315	315	
90TAs-S16-M22*1.5		16	M22x1.5	12.0	12.0	28.0	33.0	25.0	36.0	14.0	43.0	27	27	30	250	250	
90TAs-S20-M27*2.0		20	M27x2.0	16.0	15.0	33.0	38.0	28.0	39.0	16.0	49.0	30	32	36	250	250	
90TAs-S25-M33*2.0		25	M33x2.0	20.0	20.0	41.0	42.0	30.0	44.0	16.0	54.0	36	41	46	160	160	
90TAs-S30-M42*2.0		30	M42x2.0	25.0	26.0	51.0	49.0	36.0	51.0	17.0	62.0	50	50	50	160	160	
90TAs-S38-M48*2.0		38	M48x2.0	32.0	32.0	56.0	50.0	34.0	54.0	19.0	65.0	50	55	60	160	160	

订货示例:

碳钢, 无六价铬镀锌: 90TAs-L06-M10x1.0

304不锈钢: 90TAs-L06-M10x1.0-304

316不锈钢: 90TAs-L06-M10x1.0-316

注: 订货号不含螺母卡套

注: 订货号含螺母卡套 90TAs-L06-M10x1.0-NBR

90TAb 端直角可调向接头—BSPB英制螺纹

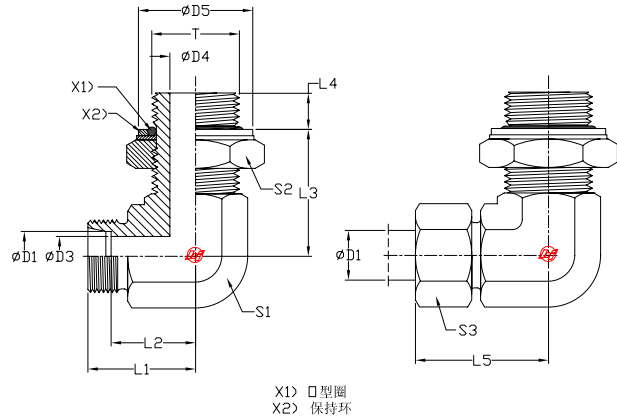

订货号	系列	钢管外径															PN(bar)	
		D1	T	D3	D4	D5 ^{a)}	D5 ^{b)}	L1	L2	L3	L4	L5	S1	S2	S3	C	SS	
90TAb-L06-02	L	06	G1/8A	4.0	4.5	15.0	15.0	21.0	14.0	19.0	7.0	29.0	14	14	14	315	315	
90TAb-L08-04		08	G1/4A	6.0	7.5	20.0	20.0	23.0	16.0	23.0	9.0	31.0	14	19	17	315	315	
90TAb-L10-04		10	G1/4A	8.0	7.5	20.0	20.0	24.0	17.0	25.0	9.0	32.0	19	19	19	315	315	
90TAb-L12-06		12	G3/8A	10.0	10.0	23.0	23.5	26.0	19.0	28.0	9.0	34.0	19	22	22	250	250	
90TAb-L15-08		15	G1/2A	12.0	12.5	28.0	28.5	28.0	21.0	30.0	13.0	36.0	22	27	27	250	250	
90TAb-L18-08		18	G1/2A	15.0	12.5	28.0	28.5	31.0	24.0	36.0	13.0	40.0	27	27	32	250	250	
90TAb-L22-12		22	G3/4A	19.0	15.5	33.0	34.5	35.0	28.0	36.0	13.0	44.0	30	36	36	160	160	
90TAb-L28-16		28	G1A	24.0	21.5	41.0	43.5	38.0	31.0	44.0	15.0	47.0	36	41	41	160	160	
90TAb-L35-20		35	G1 1/4A	30.0	27.5	51.0	52.5	48.0	38.0	50.0	15.0	59.0	50	50	50	160	160	
90TAb-L42-24		42	G1 1/2A	36.0	33.0	56.0	60.0	49.0	38.0	52.0	15.0	61.0	50	55	60	160	160	
90TAb-S06-04	S	06	G1/4A	4.0	7.5	20.0	20.0	22.0	15.0	23.0	9.0	30.0	14	19	17	315	315	
90TAb-S08-04		08	G1/4A	5.0	7.5	20.0	20.0	24.0	17.0	27.0	9.0	32.0	19	19	19	315	315	
90TAb-S10-06		10	G3/8A	7.0	10.0	23.0	23.5	25.0	18.0	29.0	9.0	34.0	19	22	22	250	250	
90TAb-S12-06		12	G3/8A	8.0	10.0	23.0	23.5	29.0	22.0	29.0	9.0	38.0	22	22	24	250	250	
90TAb-S16-08		16	G1/2A	12.0	12.5	28.0	28.5	33.0	25.0	36.0	13.0	43.0	27	27	30	250	250	
90TAb-S20-12		20	G3/4A	16.0	15.5	33.0	34.5	38.0	28.0	39.0	12.0	49.0	30	36	36	250	250	
90TAb-S25-16		25	G1A	20.0	21.5	41.0	43.5	42.0	30.0	44.0	14.0	54.0	36	41	46	250	250	
90TAb-S30-20		30	G1 1/4A	25.0	27.5	51.0	52.5	49.0	36.0	49.0	15.0	62.0	50	50	50	160	160	
90TAb-S38-24		38	G1 1/2A	32.0	33.0	56.0	60.0	50.0	34.0	55.0	15.0	65.0	50	55	60	160	160	

订货示例:

碳钢, 无六价铬镀锌: 90TAb-L06-02

304不锈钢: 90TAb-L06-02-304

316不锈钢: 90TAb-L06-02-316

注: 订货号不含螺母卡套

注: 订货号含螺母卡套 90TAb-L06-02-NBR

90TAj/90TAd 端直角可调向接头—UNF美制螺纹

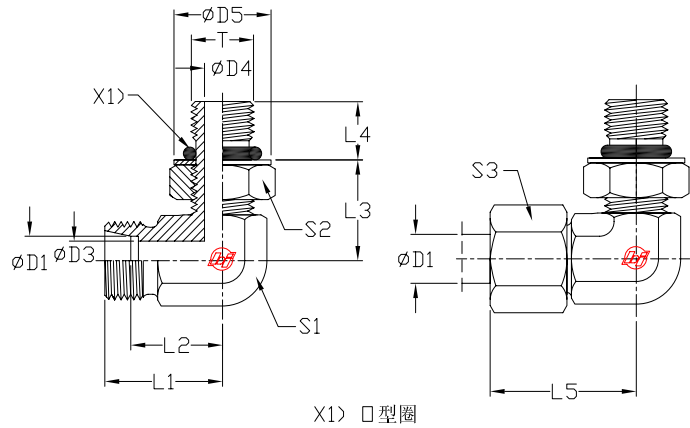

订货号	系列	钢管外径		D3	D4	D5	L1	L2	L3	L4	L5	S1	S2	S3	PN(bar)	
		D1	T												C	SS
90TAj-L06-04	L	06	7/16-20 UNF	4.0	4.5	16.5	21.0	14.0	19.0	10.0	29.0	14	14	14	315	315
90TAj-L08-04		80	7/16-20 UNF	6.0	4.5	18.3	23.0	16.0	19.0	10.0	31.0	14	14	17	315	315
90TAj-L10-06		10	9/16-18 UNF	8.0	7.5	20.2	24.0	17.0	24.0	10.0	32.0	19	17	19	315	315
90TAj-L12-06		12	9/16-18 UNF	10.0	7.5	25.7	26.0	19.0	25.0	11.0	34.0	19	17	22	315	315
90TAj-L12-08		12	3/4-16 UNF	10.0	10.0	25.7	26.0	19.0	25.0	13.0	34.0	19	22	22	315	315
90TAj-L15-08		15	3/4-16 UNF	12.0	10.0	29.3	28.0	21.0	28.0	13.0	36.0	22	22	27	315	315
90TAj-L15-10		15	7/8-14 UNF	12.0	12.5	29.3	28.0	21.0	28.0	15.0	36.0	22	27	27	315	315
90TAj-L18-10		18	7/8-14 UNF	15.0	12.5	29.3	31.0	24.0	32.0	15.0	40.0	27	27	32	315	315
90TAj-L18-12		18	1 1/16-12 UNF	15.0	15.5	29.3	31.0	24.0	32.0	17.0	40.0	30	32	32	315	315
90TAj-L22-12		22	1 1/16-12 UNF	19.0	15.5	36.7	35.0	28.0	35.0	17.0	44.0	30	32	36	160	160
90TAj-L28-16		28	1 5/16-12 UNF	24.0	21.5	44.0	38.0	31.0	42.0	17.0	47.0	36	41	41	160	160
90TAj-L35-20		35	1 5/8-12 UNF	30.0	27.5	55.0	48.0	38.0	46.0	17.0	59.0	50	50	50	160	160
90TAj-L42-24		42	1 7/8-12 UNF	36.0	33.5	55.0	49.0	38.0	47.0	17.0	61.0	50	55	60	160	160
90TAd-S06-04		s	06	7/16-20 UNF	4.0	4.5	16.5	22.0	15.0	20.0	12.0	30.0	14	14	17	400
90TAd-S08-06	08		9/16-18 UNF	5.0	7.5	18.3	24.0	17.0	25.0	12.0	32.0	19	17	19	400	400
90TAd-S10-06	10		9/16-18 UNF	7.0	7.5	20.2	25.0	18.0	26.0	12.0	34.0	19	17	22	400	400
90TAd-S12-08	12		3/4-16 UNF	8.0	10.0	25.7	29.0	22.0	30.0	14.0	38.0	22	22	24	400	400
90TAd-S16-10	16		7/8-14 UNF	12.0	12.5	29.3	33.0	25.0	34.0	16.0	43.0	27	27	30	400	400
90TAd-S20-12	20		1 1/16-12 UNF	16.0	15.5	36.7	38.0	28.0	37.0	19.0	49.0	30	32	36	400	400
90TAd-S25-12	25		1 1/16-12 UNF	20.0	15.5	44.0	42.0	30.0	50.0	19.0	54.0	36	32	46	400	400
90TAd-S30-20	30		1 5/8-12 UNF	25.0	27.5	55.0	49.0	36.0	50.0	19.0	62.0	50	50	50	250	250
90TAd-S38-24	38		1 7/8-12 UNF	32.0	33.5	55.0	50.0	34.0	51.0	19.0	65.0	50	55	60	250	250

订货示例:

碳钢, 无六价铬镀锌: 90TAj-L06-04

304不锈钢: 90TAj-L06-04-304

316不锈钢: 90TAj-L06-04-316

注: 订货号不含螺母卡套

注: 订货号含螺母卡套 90TAj-L06-04-NBR

TTAs 三通可调向接头—公制螺纹

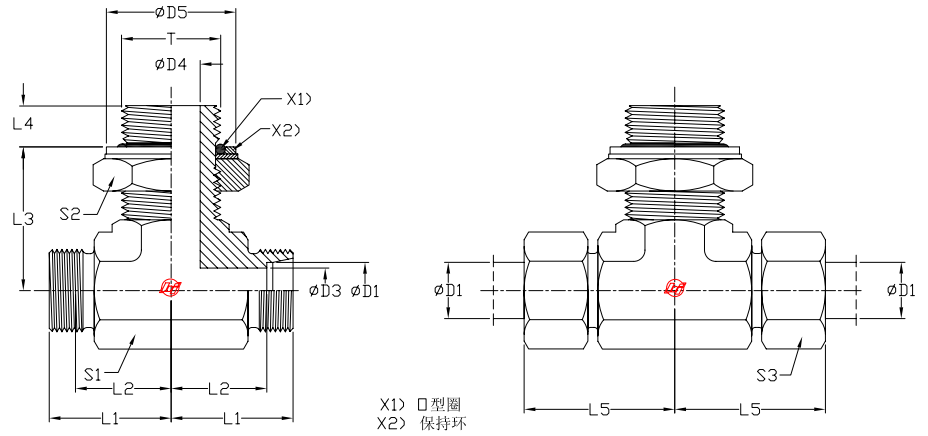

订货号	系列	钢管 外径 D1	T	D3	D4	D5	L1	L2	L3	L4	L5	S1	S2	S3	PN(bar)	
															C	SS
TTAs-L06-L06-M10*1.0	L	06	M10x1.0	4.0	4.5	15.0	21.0	14.0	20.0	7.0	29.0	14	14	14	315	315
TTAs-L08-L08-M12*1.5		08	M12x1.5	6.0	6.0	18.0	23.0	16.0	22.0	10.0	31.0	14	17	17	315	315
TTAs-L10-L10-M14*1.5		10	M14x1.5	8.0	7.5	20.0	24.0	17.0	25.0	10.0	32.0	19	19	19	315	315
TTAs-L12-L12-M16*1.5		12	M16x1.5	10.0	9.0	23.0	26.0	19.0	26.0	10.0	34.0	19	22	22	315	315
TTAs-L15-L15-M18*1.5		15	M18x1.5	12.0	11.0	25.0	28.0	21.0	30.0	11.0	36.0	22	24	27	315	315
TTAs-L18-L18-M22*1.5		18	M22x1.5	15.0	14.0	28.0	31.0	24.0	33.0	12.0	40.0	27	27	32	250	250
TTAs-L22-L22-M27*2.0		22	M27x2.0	19.0	18.0	33.0	35.0	28.0	35.0	14.0	44.0	30	32	36	160	160
TTAs-L28-L28-M33*2.0		28	M33x2.0	24.0	23.0	41.0	38.0	31.0	38.0	14.0	47.0	36	41	41	160	160
TTAs-L35-L35-M42*2.0		35	M42x2.0	30.0	30.0	51.0	48.0	38.0	48.0	14.0	59.0	50	50	50	160	160
TTAs-L42-L42-M48*2.0		42	M48x2.0	36.0	36.0	56.0	49.0	38.0	49.0	16.0	61.0	50	55	60	160	160
TTAs-S06-S06-M12*1.5	S	06	M12x1.5	4.0	4.0	18.0	22.0	15.0	22.0	10.0	30.0	14	17	17	315	315
TTAs-S08-S08-M14*1.5		08	M14x1.5	5.0	6.0	20.0	24.0	17.0	26.0	10.0	32.0	19	19	19	315	315
TTAs-S10-S10-M16*1.5		10	M16x1.5	7.0	7.0	23.0	25.0	18.0	27.0	11.0	34.0	19	22	22	315	315
TTAs-S12-S12-M18*1.5		12	M18x1.5	8.0	9.0	25.0	29.0	22.0	31.0	12.0	38.0	22	24	24	315	315
TTAs-S16-S16-M22*1.5		16	M22x1.5	12.0	12.0	28.0	33.0	25.0	35.0	14.0	43.0	27	27	30	250	250
TTAs-S20-S20-M27*2.0		20	M27x2.0	16.0	15.0	33.0	38.0	28.0	39.0	16.0	49.0	30	32	36	250	250
TTAs-S25-S25-M33*2.0		25	M33x2.0	20.0	20.0	41.0	42.0	30.0	44.0	16.0	54.0	36	41	46	160	160
TTAs-S30-S30-M42*2.0		30	M42x2.0	25.0	26.0	51.0	49.0	36.0	51.0	17.0	62.0	50	50	50	160	160
TTAs-S38-S38-M48*2.0		38	M48x2.0	32.0	32.0	56.0	50.0	34.0	54.0	19.0	65.0	50	55	60	160	160

订货示例:

碳钢, 无六价铬镀锌: TTAs-L06-L06-M10x1.0

304不锈钢: TTAs-L06-L06-M10x1.0-304

316不锈钢: TTAs-L06-L06-M10x1.0-316

注: 订货号不含螺母卡套

注: 订货号含螺母卡套 TTAs-L06-L06-M10x1.0-NBR

TTAb 三通可调向接头—BSPP英制螺纹

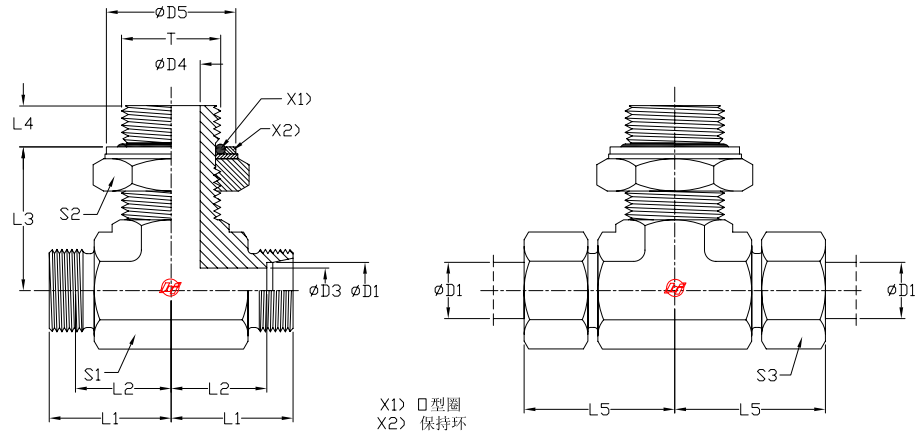

订货号	系列	钢管 外径 D1	T	D3	D4	D5 ⁵⁾	D5 ⁶⁾	L1	L2	L3	L4	L5	S1	S2	S3	PN(bar)	
																C	SS
TTAb-L06-L06-02	L	06	G1/8A	4.0	4.5	15.0	15.0	21.0	14.0	19.0	7.0	29.0	14	14	14	315	315
TTAb-L08-L08-04		08	G1/4A	6.0	7.5	20.0	20.0	23.0	16.0	23.0	9.0	31.0	14	19	17	315	315
TTAb-L10-L10-04		10	G1/4A	8.0	7.5	20.0	20.0	24.0	17.0	25.0	9.0	32.0	19	19	19	315	315
TTAb-L12-L12-06		12	G3/8A	10.0	10.0	23.0	23.5	26.0	19.0	28.0	9.0	34.0	19	22	22	250	250
TTAb-L15-L15-08		15	G1/2A	12.0	12.5	28.0	28.5	28.0	21.0	30.0	13.0	36.0	22	27	27	250	250
TTAb-L18-L18-08		18	G1/2A	15.0	12.5	28.0	28.5	31.0	24.0	36.0	13.0	40.0	27	27	32	250	250
TTAb-L22-L22-12		22	G3/4A	19.0	15.5	33.0	34.5	35.0	28.0	36.0	13.0	44.0	30	36	36	160	160
TTAb-L28-L28-16		28	G1A	24.0	21.5	41.0	43.5	38.0	31.0	44.0	15.0	47.0	36	41	41	160	160
TTAb-L35-L35-20		35	G 1 1/4A	30.0	27.5	51.0	52.5	48.0	38.0	50.0	15.0	59.0	50	50	50	160	160
TTAb-L42-L42-24		42	G 1 1/2A	36.0	33.0	56.0	60.0	49.0	38.0	52.0	15.0	61.0	50	50	60	160	160
TTAb-S06-S06-04	S	06	G1/4A	4.0	7.5	20.0	20.0	22.0	15.0	23.0	9.0	30.0	14	19	17	315	315
TTAb-S08-S08-04		08	G1/4A	5.0	7.5	20.0	20.0	24.0	17.0	27.0	9.0	32.0	19	19	19	315	315
TTAb-S10-S10-06		10	G3/8A	7.0	10.0	23.0	23.5	25.0	18.0	29.0	9.0	34.0	19	22	22	250	250
TTAb-S12-S12-06		12	G3/8A	8.0	10.0	23.0	23.5	29.0	22.0	29.0	9.0	38.0	22	22	24	250	250
TTAb-S16-S16-08		16	G1/2A	12.0	12.5	28.0	28.5	33.0	25.0	36.0	13.0	43.0	27	27	30	250	250
TTAb-S20-S20-12		20	G3/4A	16.0	15.5	33.0	34.5	38.0	28.0	39.0	12.0	49.0	30	36	36	250	250
TTAb-S25-S25-16		25	G1A	20.0	21.5	41.0	43.5	42.0	30.0	44.0	14.0	54.0	36	41	46	250	250
TTAb-S30-S30-20		30	G 1 1/4A	25.0	27.5	51.0	52.5	49.0	36.0	49.0	15.0	62.0	50	50	50	160	160
TTAb-S38-S38-24		38	G 1 1/2A	32.0	33.0	56.0	60.0	50.0	34.0	55.0	15.0	65.0	50	55	60	160	160

订货示例:

碳钢, 无六价铬镀锌: TTAAb-L06-L06-02

304不锈钢: TTAAb-L06-L06-02-304

316不锈钢: TTAAb-L06-L06-02-316

注: 订货号不含螺母卡套

注: 订货号含螺母卡套 TTAAb-L06-L06-02-NBR

TTAj/TTAd 三通可调向接头—UNF美制螺纹

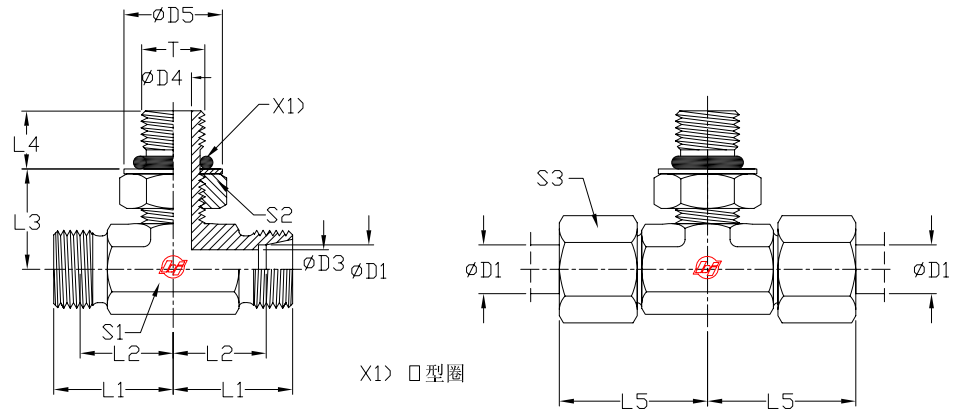

订货号	系列	钢管 外径 D1	T	D3	D4	D5	L1	L2	L3	L4	L5	S1	S2	S3	PN(bar)	
															C	SS
TTAj-L06-L06-04	L	06	7/16-20 UNF	4.0	4.5	16.5	21.0	14.0	19.0	10.0	29.0	14	14	14	315	315
TTAj-L08-L08-04		08	7/16-20 UNF	6.0	4.5	18.3	23.0	16.0	19.0	10.0	31.0	14	14	17	315	315
TTAj-L10-L10-06		10	9/16-18 UNF	8.0	7.5	20.2	24.0	17.0	24.0	10.0	32.0	19	17	19	315	315
TTAj-L12-L12-06		12	9/16-18 UNF	10.0	7.5	25.7	26.0	19.0	25.0	11.0	34.0	19	17	22	315	315
TTAj-L12-L12-08		12	3/4-16 UNF	10.0	10.0	25.7	26.0	19.0	25.0	13.0	34.0	19	22	22	315	315
TTAj-L15-L15-08		15	3/4-16 UNF	12.0	10.0	29.3	28.0	21.0	28.0	13.0	36.0	22	22	27	315	315
TTAj-L15-L15-10		15	7/8-14 UNF	12.0	12.5	29.3	28.0	21.0	28.0	15.0	36.0	22	27	27	315	315
TTAj-L18-L18-10		18	7/8-14 UNF	15.0	12.5	29.3	31.0	24.0	32.0	15.0	40.0	27	27	32	315	315
TTAj-L18-L18-12		18	1 1/16-12 UNF	15.0	15.5	29.3	31.0	24.0	32.0	17.0	40.0	30	32	32	315	315
TTAj-L22-L22-12		22	1 1/16-12 UNF	19.0	15.5	36.7	35.0	28.0	35.0	17.0	44.0	30	32	36	160	160
TTAj-L28-L28-16		28	1 5/16-12 UNF	24.0	21.5	44.0	38.0	31.0	42.0	17.0	47.0	36	41	41	160	160
TTAj-L35-L35-20		35	1 5/8-12 UNF	30.0	27.5	55.0	48.0	38.0	46.0	17.0	59.0	50	50	50	160	160
TTAj-L42-L42-24		42	1 7/8-12 UNF	36.0	33.5	55.0	49.0	38.0	47.0	17.0	61.0	50	55	60	160	160
TTAd-S06-S06-04	S	06	7/16-20 UNF	4.0	4.5	16.5	22.0	15.0	20.0	12.0	30.0	14	14	17	400	400
TTAd-S08-S08-06		08	9/16-18 UNF	5.0	7.5	18.3	24.0	17.0	25.0	12.0	32.0	19	17	19	400	400
TTAd-S10-S10-06		10	9/16-18 UNF	7.0	7.5	20.2	25.0	18.0	26.0	12.0	34.0	19	17	22	400	400
TTAd-S12-S12-08		12	3/4-16 UNF	8.0	10.0	25.7	29.0	22.0	30.0	14.0	38.0	22	22	24	400	400
TTAd-S16-S16-10		16	7/8-14 UNF	12.0	12.5	29.3	33.0	25.0	34.0	16.0	43.0	27	27	30	400	400
TTAd-S20-S20-12		20	1 1/16-12 UNF	16.0	15.5	36.7	38.0	28.0	37.0	19.0	49.0	30	32	36	400	400
TTAd-S25-S25-12		25	1 1/16-12 UNF	20.0	15.5	44.0	42.0	30.0	50.0	19.0	54.0	36	32	46	400	400
TTAd-S30-S30-20		30	1 5/8-12 UNF	25.0	27.5	55.0	49.0	36.0	50.0	19.0	62.0	50	50	50	250	250
TTAd-S38-S38-24		38	1 7/8-12 UNF	32.0	33.5	55.0	50.0	34.0	51.0	19.0	65.0	50	55	60	250	250

订货示例:

碳钢, 无六价铬镀锌: TTAj-L06-L06-04

304不锈钢: TTAj-L06-L06-04-304

316不锈钢: TTAj-L06-L06-04-316

注: 订货号不含螺母卡套

注: 订货号含螺母卡套 TTAj-L06-L06-04-NBR

TAsT 三通可调向接头—公制螺纹

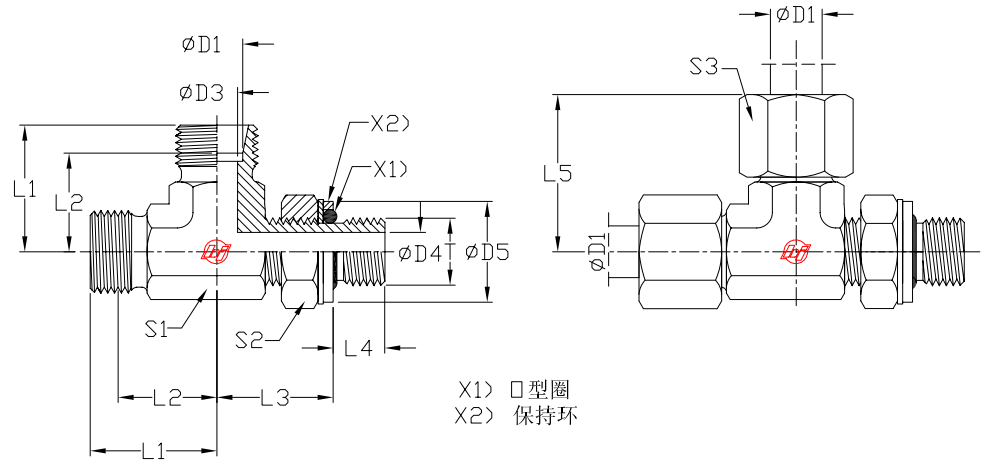

订货号	系列	钢管 外径	T	D3	D4	D5	L1	L2	L3	L4	L5	S1	S2	S3	PN(bar)	
															C	SS
TAsT-L06-M10*1.0-L06	L	06	M10x1.0	4.0	4.5	15.0	21.0	14.0	20.0	7.0	29.0	14	14	14	315	315
TAsT-L08-M12*1.5-L08		08	M12x1.5	6.0	6.0	18.0	23.0	16.0	22.0	10.0	31.0	14	17	17	315	315
TAsT-L10-M14*1.5-L10		10	M14x1.5	8.0	7.5	20.0	24.0	17.0	25.0	9.0	32.0	19	19	19	315	315
TAsT-L12-M16*1.5-L12		12	M16x1.5	10.0	9.0	23.0	26.0	19.0	26.0	9.0	34.0	19	22	22	315	315
TAsT-L15-M18*1.5-L15		15	M18x1.5	12.0	11.0	25.0	28.0	21.0	30.0	11.0	36.0	22	24	27	315	315
TAsT-L18-M22*1.5-L18		18	M22x1.5	15.0	14.0	28.0	31.0	24.0	33.0	11.0	40.0	27	27	32	250	250
TAsT-L22-M27*2.0-L22		22	M27x2.0	19.0	18.0	33.0	35.0	28.0	35.0	14.0	44.0	30	32	36	160	160
TAsT-L28-M33*2.0-L28		28	M33x2.0	24.0	23.0	41.0	38.0	31.0	38.0	14.0	47.0	36	41	41	160	160
TAsT-L35-M42*2.0-L35		35	M42x2.0	30.0	30.0	51.0	48.0	38.0	48.0	14.0	59.0	50	50	50	160	160
TAsT-L42-M48*2.0-L42		42	M48x2.0	36.0	36.0	56.0	49.0	38.0	49.0	16.0	61.0	50	55	60	160	160
TAsT-S06-M12*1.5-S06	S	06	M12x1.5	4.0	4.0	18.0	22.0	15.0	22.0	10.0	30.0	14	17	17	315	315
TAsT-S08-M14*1.5-S08		08	M14x1.5	5.0	6.0	20.0	24.0	17.0	26.0	10.0	32.0	19	19	19	315	315
TAsT-S10-M16*1.5-S10		10	M16x1.5	7.0	7.0	23.0	25.0	18.0	27.0	11.0	34.0	19	22	22	315	315
TAsT-S12-M18*1.5-S12		12	M18x1.5	8.0	9.0	25.0	29.0	22.0	31.0	12.0	38.0	22	24	24	315	315
TAsT-S16-M22*1.5-S16		16	M22x1.5	12.0	12.0	28.0	33.0	25.0	35.0	14.0	43.0	27	27	30	250	250
TAsT-S20-M27*2.0-S20		20	M27x2.0	16.0	15.0	33.0	38.0	28.0	39.0	16.0	49.0	30	32	36	250	250
TAsT-S25-M33*2.0-S25		25	M33x2.0	20.0	20.0	41.0	42.0	30.0	44.0	16.0	54.0	36	41	46	160	160
TAsT-S30-M42*2.0-S30		30	M42x2.0	25.0	26.0	51.0	49.0	36.0	51.0	17.0	62.0	50	50	50	160	160
TAsT-S38-M48*2.0-S38		38	M48x2.0	32.0	32.0	56.0	50.0	34.0	54.0	19.0	65.0	50	55	60	160	160

订货示例:

碳钢, 无六价铬镀锌: TAsT-L06-M10x1.0-L06

304不锈钢: TAsT-L06-M10x1.0-L06-304

316不锈钢: TAsT-L06-M10x1.0-L06-316

注: 订货号不含螺母卡套

注: 订货号含螺母卡套 TAsT-L06-M10x1.0-L06-NBR

TAiT 三通可调向接头—BSPP英制螺纹

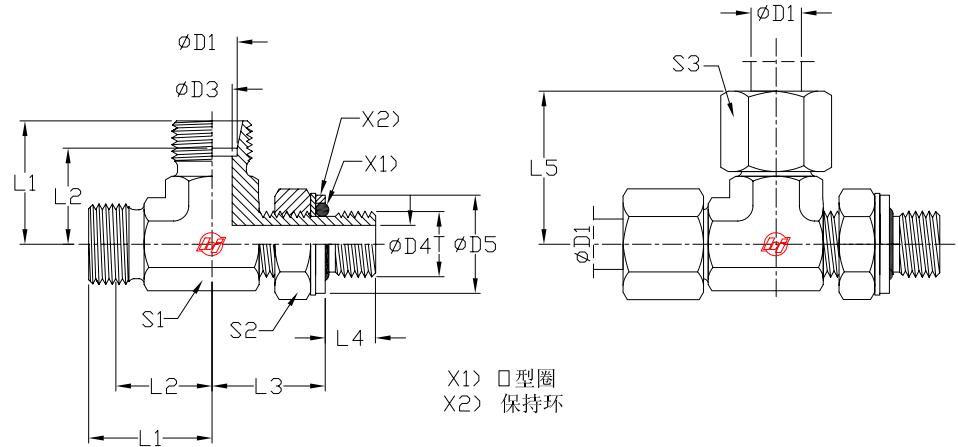

订货号	系列	钢管 外径 D1	T	D3	D4	D5 ⁵⁾	D5 ⁶⁾	L1	L2	L3	L4	L5	S1	S2	S3	PN(bar)	
																C	SS
TAbT-L06-02-L06	L	06	G1/8A	4.0	4.5	15.0	15.0	21.0	14.0	19.0	7.0	29.0	14	14	14	315	315
TAbT-L08-04-L08		08	G1/4A	6.0	7.5	20.0	20.0	23.0	16.0	23.0	9.0	31.0	14	19	17	315	315
TAbT-L10-04-L10		10	G1/4A	8.0	7.5	20.0	20.0	24.0	17.0	25.0	9.0	32.0	19	19	19	315	315
TAbT-L12-06-L12		12	G3/8A	10.0	10.0	23.0	23.5	26.0	19.0	28.0	9.0	34.0	19	22	22	250	250
TAbT-L15-08-L15		15	G1/2A	12.0	12.5	28.0	28.5	28.0	21.0	30.0	13.0	36.0	22	27	27	250	250
TAbT-L18-08-L18		18	G1/2A	15.0	12.5	28.0	28.5	31.0	24.0	36.0	13.0	40.0	27	27	32	250	250
TAbT-L22-12-L22		22	G3/4A	19.0	15.5	33.0	34.5	35.0	28.0	36.0	13.0	44.0	30	36	36	160	160
TAbT-L28-16-L28		28	G1A	24.0	21.5	41.0	43.5	38.0	31.0	44.0	15.0	47.0	36	41	41	160	160
TAbT-L35-20-L35		35	G 1 1/4A	30.0	27.5	51.0	52.5	48.0	38.0	50.0	15.0	59.0	50	50	50	160	160
TAbT-L42-24-L42		42	G 1 1/2A	36.0	33.0	56.0	60.0	49.0	38.0	52.0	15.0	61.0	50	55	60	160	160
TAbT-S06-04-S06	S	06	G1/4A	4.0	7.5	20.0	20.0	22.0	15.0	23.0	9.0	30.0	14	19	17	315	315
TAbT-S08-04-S08		08	G1/4A	5.0	7.5	20.0	20.0	24.0	17.0	27.0	9.0	32.0	19	19	19	315	315
TAbT-S10-06-S10		10	G3/8A	7.0	10.0	23.0	23.5	25.0	18.0	29.0	9.0	34.0	19	22	22	250	250
TAbT-S12-06-S12		12	G3/8A	8.0	10.0	23.0	23.5	29.0	22.0	29.0	9.0	38.0	22	22	24	250	250
TAbT-S16-08-S16		16	G1/2A	12.0	12.5	28.0	28.5	33.0	25.0	36.0	13.0	43.0	27	27	30	250	250
TAbT-S20-12-S20		20	G3/4A	16.0	15.5	33.0	34.5	38.0	28.0	39.0	12.0	49.0	30	36	36	250	250
TAbT-S25-16-S25		25	G1A	20.0	21.5	41.0	43.5	42.0	30.0	44.0	14.0	54.0	36	41	46	250	250
TAbT-S30-20-S30		30	G 1 1/4A	25.0	27.5	51.0	52.5	49.0	36.0	49.0	15.0	62.0	50	50	50	160	160
TAbT-S38-24-S38		38	G 1 1/2A	32.0	33.0	56.0	60.0	50.0	34.0	55.0	15.0	65.0	50	55	60	160	160

订货示例:

碳钢, 无六价铬镀锌: TAbT-L06-02-L06

304不锈钢: TAbT-L06-02-L06-304

316不锈钢: TAbT-L06-02-L06-316

注: 订货号不含螺母卡套

注: 订货号含螺母卡套 TAbT-L06-02-L06-NBR

TAjT/TAdT 三通可调向接头—UNF美制螺纹

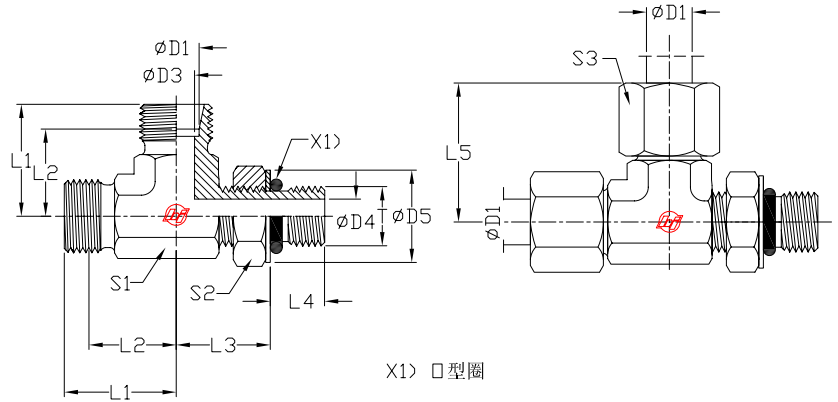

订货号	系列	钢管 外径	T	D3	D4	D5	L1	L2	L3	L4	L5	S1	S2	S3	PN(bar)	
		D1													C	SS
TAjT-L06-04-L06	L	06	7/16-20 UNF	4.0	4.5	16.5	21.0	14.0	19.0	10.0	29.0	14	14	14	315	315
TAjT-L08-04-L08		08	7/16-20 UNF	6.0	4.5	18.3	23.0	16.0	19.0	10.0	31.0	14	14	17	315	315
TAjT-L10-06-L10		10	9/16-18 UNF	8.0	7.5	20.2	24.0	17.0	24.0	10.0	32.0	19	17	19	315	315
TAjT-L12-06-L12		12	9/16-18 UNF	10.0	7.5	25.7	26.0	19.0	25.0	11.0	34.0	19	17	22	315	315
TAjT-L12-08-L12		12	3/4-16 UNF	10.0	10.0	25.7	26.0	19.0	25.0	13.0	34.0	19	22	22	315	315
TAjT-L15-08-L15		15	3/4-16 UNF	12.0	10.0	29.3	28.0	21.0	28.0	13.0	36.0	22	22	27	315	315
TAjT-L15-10-L15		15	7/8-14 UNF	12.0	12.5	29.3	28.0	21.0	28.0	15.0	36.0	22	27	27	315	315
TAjT-L18-10-L18		18	7/8-14 UNF	15.0	12.5	29.3	31.0	24.0	32.0	15.0	40.0	27	27	32	315	315
TAjT-L18-12-L18		18	1 1/16-12 UNF	15.0	15.5	29.3	31.0	24.0	32.0	17.0	40.0	30	32	32	315	315
TAjT-L22-12-L22		22	1 1/16-12 UNF	19.0	15.5	36.7	35.0	28.0	35.0	17.0	44.0	30	32	36	160	160
TAjT-L28-16-L28		28	1 5/16-12 UNF	24.0	21.5	44.0	38.0	31.0	42.0	17.0	47.0	36	41	41	160	160
TAjT-L35-20-L35		35	1 5/8-12 UNF	30.0	27.5	55.0	48.0	38.0	46.0	17.0	59.0	50	50	50	160	160
TAjT-L42-24-L42	42	1 7/8-12 UNF	36.0	33.5	55.0	49.0	38.0	47.0	17.0	61.0	50	55	60	160	160	
TAdT-S06-04-S06	S	06	7/16-20 UNF	4.0	4.5	16.5	22.0	15.0	20.0	12.0	30.0	14	14	17	400	400
TAdT-S08-06-S08		08	9/16-18 UNF	5.0	7.5	18.3	24.0	17.0	25.0	12.0	32.0	19	17	19	400	400
TAdT-S10-06-S10		10	9/16-18 UNF	7.0	7.5	20.2	25.0	18.0	26.0	12.0	34.0	19	17	22	400	400
TAdT-S12-08-S12		12	3/4-16 UNF	8.0	10.0	25.7	29.0	22.0	30.0	14.0	38.0	22	22	24	400	400
TAdT-S16-10-S16		16	7/8-14 UNF	12.0	12.5	29.3	33.0	25.0	34.0	16.0	43.0	27	27	30	400	400
TAdT-S20-12-S20		20	1 1/16-12 UNF	16.0	15.5	36.7	38.0	28.0	37.0	19.0	49.0	30	32	36	400	400
TAdT-S25-12-S25		25	1 1/16-12 UNF	20.0	15.5	44.0	42.0	30.0	50.0	19.0	54.0	36	32	46	400	400
TAdT-S30-20-S30		30	1 5/8-12 UNF	25.0	27.5	55.0	49.0	36.0	50.0	19.0	62.0	50	50	50	250	250
TAdT-S38-24-S38		38	1 7/8-12 UNF	32.0	33.5	55.0	50.0	34.0	51.0	19.0	65.0	50	55	60	250	250

订货示例:

碳钢, 无六价铬镀锌: TAjT-L06-04-L06

304不锈钢: TAjT-L06-04-L06-304

316不锈钢: TAjT-L06-04-L06-316

注: 订货号不含螺母卡套

注: 订货号含螺母卡套TAjT-L06-04-L06-NBR

45TAs 45° 可调向接头—公制螺纹

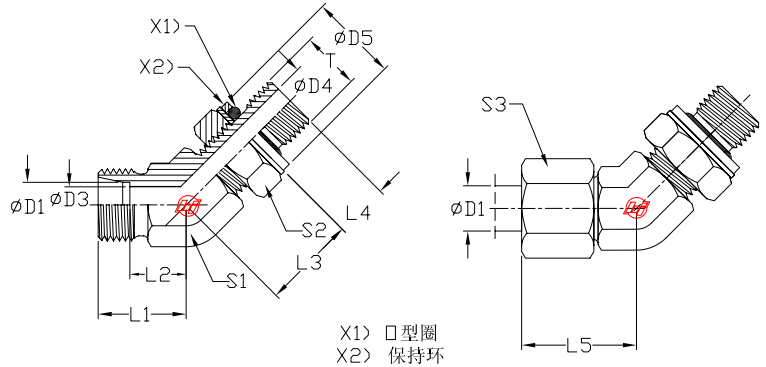

订货号	系列	钢管 外径	T	D3	D4	D5	L1	L2	L3	L4	L5	S1	S2	S3	PN(bar)	
															D1	C
45TAs-L06-M10*1.0	L	06	M10x1.0	4.0	4.5	15.0	16.0	9.0	21.0	7.0	24.0	14	14	14	315	315
45TAs-L08-M12*1.5		08	M12x1.5	6.0	6.0	18.0	19.0	12.0	19.0	10.0	27.0	14	17	17	315	315
45TAs-L10-M14*1.5		10	M14x1.5	8.0	7.5	20.0	19.0	12.0	24.0	9.0	27.0	19	19	19	315	315
45TAs-L12-M16*1.5		12	M16x1.5	10.0	9.0	23.0	21.0	14.0	25.0	9.0	28.0	19	22	22	315	315
45TAs-L15-M18*1.5		15	M18x1.5	12.0	11.0	25.0	24.0	17.0	24.0	11.0	32.0	22	24	27	315	315
45TAs-L18-M22*1.5		18	M22x1.5	15.0	14.0	28.0	24.0	17.0	31.0	11.0	33.0	27	27	32	250	250
45TAs-L22-M27*2.0		22	M27x2.0	19.0	18.0	33.0	26.0	19.0	31.0	14.0	35.0	30	32	36	160	160
45TAs-L28-M33*2.0		28	M33x2.0	24.0	23.0	41.0	31.0	23.0	35.0	14.0	40.0	36	41	41	160	160
45TAs-L35-M42*2.0		35	M42x2.0	30.0	30.0	51.0	37.0	27.0	37.0	14.0	48.0	50	50	50	160	160
45TAs-L42-M48*2.0		42	M48x2.0	36.0	36.0	56.0	37.0	26.0	37.0	16.0	49.0	50	55	60	160	160
45TAs-S06-M12*1.5	S	06	M12x1.5	4.0	4.0	18.0	16.0	9.0	19.0	10.0	24.0	14	17	17	315	315
45TAs-S08-M14*1.5		08	M14x1.5	5.0	6.0	20.0	19.0	12.0	19.0	10.0	27.0	19	19	19	315	315
45TAs-S10-M16*1.5		10	M16x1.5	7.0	7.0	23.0	21.0	13.0	23.0	11.0	29.0	19	22	22	315	315
45TAs-S12-M18*1.5		12	M18x1.5	8.0	9.0	25.0	24.0	17.0	25.0	12.0	33.0	22	24	24	315	315
45TAs-S16-M22*1.5		16	M22x1.5	12.0	12.0	28.0	24.0	16.0	30.0	14.0	34.0	27	27	30	250	250
45TAs-S20-M27*2.0		20	M27x2.0	16.0	15.0	33.0	27.0	16.0	35.0	16.0	38.0	30	32	36	250	250
45TAs-S25-M33*2.0		25	M33x2.0	20.0	20.0	41.0	31.0	19.0	37.0	16.0	43.0	36	41	46	160	160
45TAs-S30-M42*2.0		30	M42x2.0	25.0	26.0	51.0	37.0	24.0	37.0	17.0	50.0	50	50	50	160	160
45TAs-S38-M48*2.0		38	M48x2.0	32.0	32.0	56.0	37.0	21.0	38.0	19.0	52.0	50	55	60	160	160

订货示例:

碳钢, 无六价铬镀锌: 45TAs-L06-M10x1.0

304不锈钢: 45TAs-L06-M10x1.0-304

316不锈钢: 45TAs-L06-M10x1.0-316

注: 订货号不含螺母卡套

注: 订货号含螺母卡套 45TAs-L06-M10x1.0-NBR

45TAb 45°可调向接头—BSPP英制螺纹

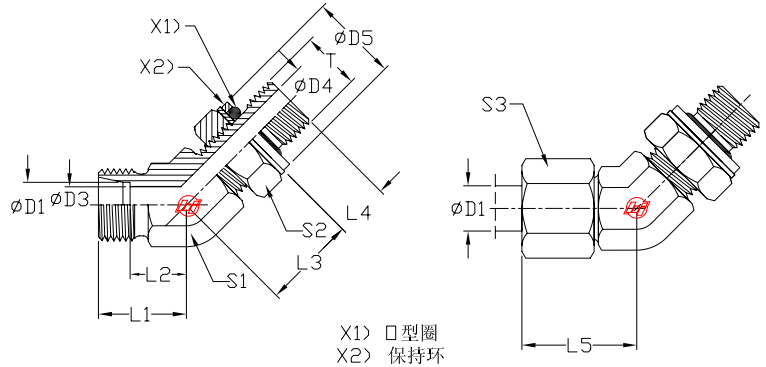

订货号	系列	钢管 外径	T	D3	D4	D5 ⁵⁾	D5 ⁶⁾	L1	L2	L3	L4	L5	S1	S2	S3	PN(bar)	
																C	SS
45TAb-L06-02	L	06	G1/8A	4.0	4.5	15.0	15.0	16.0	9.0	21.0	7.0	24.0	14	14	14	315	315
45TAb-L08-04		08	G1/4A	6.0	7.5	20.0	20.0	19.0	12.0	20.0	9.0	27.0	14	19	17	315	315
45TAb-L10-04		10	G1/4A	8.0	7.5	20.0	20.0	19.0	12.0	25.0	9.0	27.0	19	19	19	315	315
45TAb-L12-06		12	G3/8A	10.0	10.0	23.0	23.5	21.0	14.0	28.0	9.0	28.0	19	22	22	250	250
45TAb-L15-08		15	G1/2A	12.0	12.5	28.0	28.5	24.0	17.0	26.0	13.0	32.0	22	27	27	250	250
45TAb-L18-08		18	G1/2A	15.0	12.5	28.0	28.5	24.0	17.0	32.0	13.0	33.0	27	27	32	250	250
45TAb-L22-12		22	G3/4A	19.0	15.5	33.0	34.5	26.0	19.0	37.0	13.0	35.0	30	36	36	160	160
45TAb-L28-16		28	G1A	24.0	21.5	41.0	43.5	31.0	23.0	37.0	15.0	40.0	36	41	41	160	160
45TAb-L35-20		35	G 1 1/4A	30.0	27.5	51.0	52.5	37.0	27.0	39.0	15.0	48.0	50	50	50	160	160
45TAb-L42-24		42	G 1 1/2A	36.0	33.0	56.0	60.0	37.0	26.0	39.0	15.0	49.0	50	55	60	160	160
45TAb-S06-04	S	06	G1/4A	4.0	7.5	20.0	20.0	16.0	9.0	19.0	9.0	24.0	14	19	17	315	315
45TAb-S08-04		08	G1/4A	5.0	7.5	20.0	20.0	19.0	12.0	23.0	9.0	27.0	19	19	19	315	315
45TAb-S10-06		10	G3/8A	7.0	10.0	23.0	23.5	21.0	13.0	25.0	9.0	29.0	19	22	22	250	250
45TAb-S12-06		12	G3/8A	8.0	10.0	23.0	23.5	24.0	17.0	25.0	9.0	33.0	22	22	24	250	250
45TAb-S16-08		16	G1/2A	12.0	12.5	28.0	28.5	24.0	16.0	31.0	13.0	34.0	27	27	30	250	250
45TAb-S20-12		20	G3/4A	16.0	15.5	33.0	34.5	27.0	16.0	34.0	12.0	38.0	30	36	36	250	250
45TAb-S25-16		25	G1A	20.0	21.5	41.0	43.5	31.0	19.0	37.0	14.0	43.0	36	41	46	250	250
45TAb-S30-20		30	G 1 1/4A	25.0	27.5	51.0	52.5	37.0	24.0	38.0	15.0	50.0	50	50	50	160	160
45TAb-S38-24		38	G 1 1/2A	32.0	33.0	56.0	60.0	37.0	21.0	38.0	15.0	52.0	50	55	60	160	160

订货示例:

碳钢, 无六价铬镀锌: 45TAb-L06-02

304不锈钢: 45TAb-L06-02-304

316不锈钢: 45TAb-L06-02-316

注: 订货号不含螺母卡套

注: 订货号含螺母卡套 45TAb-L06-02-NBR

45TAj/45TAd 45° 可调向接头—UNF美制螺纹

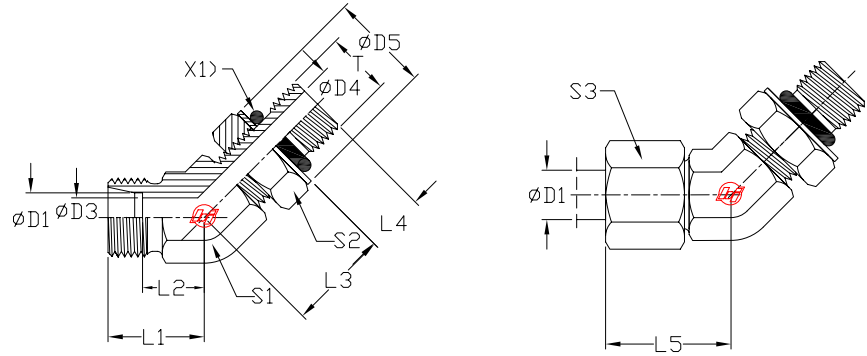

X1) O型圈

订货号	系列	钢管 外径 D1	T	D3	D4	D5	L1	L2	L3	L4	L5	S1	S2	S3	PN(bar)	
															c	ss
45TAj-L06-04	L	06	7/16-20 UNF	4.0	4.5	16.5	16.0	9.0	19.0	10.0	24.0	14	14	14	315	315
45TAj-L08-04		08	7/16-20 UNF	6.0	4.5	18.3	19.0	12.0	19.0	10.0	27.0	14	14	17	315	315
45TAj-L10-06		10	9/16-18 UNF	8.0	7.5	20.2	19.0	12.0	24.0	10.0	27.0	19	17	19	315	315
45TAj-L12-06		12	9/16-18 UNF	10.0	7.5	25.7	21.0	14.0	24.0	11.0	28.0	19	17	22	315	315
45TAj-L12-08		12	3/4-16 UNF	10.0	10.0	25.7	21.0	14.0	24.0	13.0	28.0	19	22	22	315	315
45TAj-L15-08		15	3/4-16 UNF	12.0	10.0	29.3	24.0	17.0	24.0	13.0	32.0	22	22	27	315	315
45TAj-L15-10		15	7/8-14 UNF	12.0	12.5	29.3	24.0	17.0	24.0	15.0	32.0	22	27	27	315	315
45TAj-L18-10		18	7/8-14 UNF	15.0	12.5	29.3	24.0	17.0	30.0	15.0	33.0	27	27	32	315	315
45TAj-L18-12		18	1 1/16-12 UNF	15.0	15.5	29.3	24.0	17.0	30.0	17.0	33.0	30	32	32	315	315
45TAj-L22-12		22	1 1/16-12 UNF	19.0	15.5	36.7	26.0	19.0	33.0	17.0	35.0	30	32	36	160	160
45TAj-L28-16		28	1 5/16-12 UNF	24.0	21.5	44.0	31.0	23.0	35.0	17.0	39.0	36	41	41	160	160
45TAj-L35-20		35	1 5/8-12 UNF	30.0	27.5	55.0	37.0	27.0	37.0	17.0	48.0	50	50	50	160	160
45TAj-L42-24		42	1 7/8-12 UNF	36.0	33.5	55.0	37.0	26.0	37.0	17.0	49.0	50	55	60	160	160
45TAd-S06-04		S	06	7/16-20 UNF	4.0	4.5	16.5	16.0	9.0	18.0	12.0	24.0	14	14	17	400
45TAd-S08-06	08		9/16-18 UNF	5.0	7.5	18.3	19.0	12.0	21.0	12.0	27.0	19	17	19	400	400
45TAd-S10-06	10		9/16-18 UNF	7.0	7.5	20.2	21.0	13.0	21.0	12.0	29.0	19	17	22	400	400
45TAd-S12-08	12		3/4-16 UNF	8.0	10.0	25.7	24.0	17.0	22.0	14.0	33.0	22	22	24	400	400
45TAd-S16-10	16		7/8-14 UNF	12.0	12.5	29.3	24.0	16.0	29.0	16.0	34.0	27	27	30	400	400
45TAd-S20-12	20		1 1/16-12 UNF	16.0	15.5	36.7	27.0	16.0	31.0	19.0	38.0	30	32	36	400	400
45TAd-S25-12	25		1 1/16-12 UNF	20.0	15.5	44.0	31.0	30.0	33.0	19.0	54.0	36	32	46	400	400
45TAd-S30-20	30		1 5/8-12 UNF	25.0	27.5	55.0	37.0	24.0	35.0	19.0	50.0	50	50	50	250	250
45TAd-S38-24	38		1 7/8-12 UNF	32.0	33.5	55.0	37.0	21.0	35.0	19.0	52.0	50	55	60	250	250

订货示例:

碳钢, 无六价铬镀锌: 45TAj-L06-04

304不锈钢: 45TAj-L06-04-304

316不锈钢: 45TAj-L06-04-316

注: 订货号不含螺母卡套

注: 订货号含螺母卡套 45TAj-L06-04-NBR

BJ-90TOe/BJ-90TOf 90°高压铰接式接头—公制螺纹

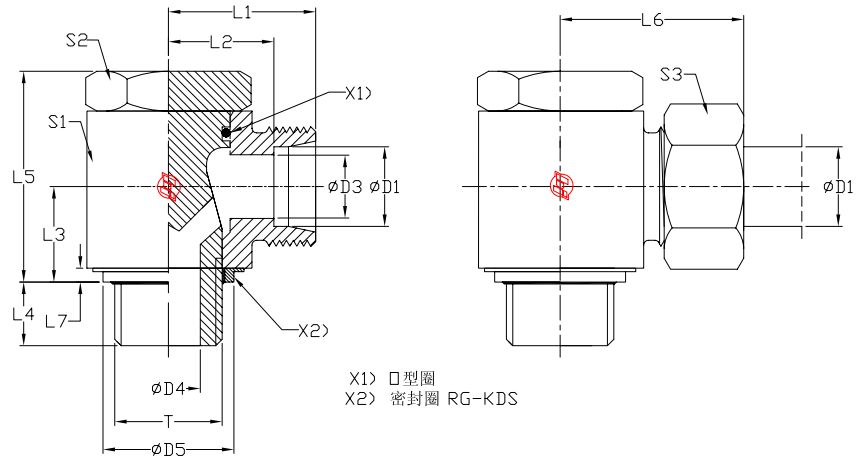

订货号	系列	钢管 外径														PN(bar)			
			D1	T	D3	D4	D5	L1	L2	L3	L4	L5	L6	L7	S1	S2	S3	C	SS
			L																
BJ-90TOe-L06-M10*1.0		06	M 10x1.0	4.0	4.5	14.9	19.0	12.0	10.5	8.0	24.0	27.0	2.5	17	17	14	315	315	
BJ-90TOe-L08-M12*1.5		08	M 12x1.5	6.0	6.0	17.0	21.5	14.5	14.0	12.0	30.0	29.0	3.0	22	19	17	315	315	
BJ-90TOe-L10-M14*1.5		10	M 14x1.5	8.0	6.0	18.9	22.5	15.5	14.0	12.0	30.0	30.0	3.0	22	19	19	315	315	
BJ-90TOe-L12-M16*1.5		12	M 16x1.5	10.0	7.5	21.9	25.0	18.0	16.5	12.0	36.0	33.0	3.0	27	24	22	315	315	
BJ-90TOe-L15-M18*1.5		15	M 18x1.5	11.0	9.0	23.9	27.5	21.5	18.5	12.0	39.5	37.0	3.0	30	30	27	315	315	
BJ-90TOe-L18-M22*1.5		18	M 22x1.5	15.0	12.0	26.9	28.5	21.0	21.5	14.0	45.0	37.0	4.5	32	30	32	315	315	
BJ-90TOe-L22-M26*1.5		22	M 26x1.5	19.0	17.0	31.9	35.0	27.5	24.0	16.0	53.0	44.0	3.5	41	36	36	160	160	
BJ-90TOe-L28-M33*2.0		28	M 33x2.0	24.0	21.0	39.9	39.5	32.0	30.5	18.0	66.0	49.0	3.5	50	46	41	160	160	
BJ-90TOe-L35-M42*2.0		35	M 42x2.0	30.0	27.0	49.9	46.5	36.0	35.5	20.0	76.0	58.0	3.5	60	55	50	160	160	
BJ-90TOe-L42-M48*2.0		42	M 48x2.0	36.0	34.0	55.9	51.5	40.5	40.5	22.0	87.0	63.0	3.5	70	60	60	160	160	
S																			
BJ-90TOf-S06-M12*1.5		06	M 12x1.5	4.0	6.0	17.0	23.5	16.5	14.0	12.0	30.0	31.0	3.0	22	19	17	400	400	
BJ-90TOf-S08-M14*1.5		08	M 14x1.5	5.0	6.0	18.9	23.5	16.5	14.0	12.0	30.0	31.0	3.0	22	19	19	400	400	
BJ-90TOf-S10-M16*1.5		10	M 16x1.5	7.0	7.5	21.9	26.0	18.5	16.5	12.0	36.0	35.0	3.0	27	24	22	400	400	
BJ-90TOf-S12-M18*1.5		12	M 18x1.5	8.0	9.0	23.9	27.5	20.0	18.5	12.0	39.5	36.0	3.0	27	27	24	400	400	
BJ-90TOf-S14-M20*1.5		14	M 20x1.5	10.0	10.0	24.9	30.5	22.5	20.0	14.0	43.5	40.0	3.0	32	30	27	400	400	
BJ-90TOf-S16-M22*1.5		16	M 22x1.5	12.0	12.0	26.9	30.5	22.0	21.5	14.0	45.0	40.0	4.5	32	30	30	315	315	
BJ-90TOf-S20-M27*2.0		20	M 27x2.0	16.0	16.0	32.9	37.0	26.5	24.0	16.0	53.0	48.0	3.5	41	36	36	315	315	
BJ-90TOf-S25-M33*2.0		25	M 33x2.0	20.0	21.0	39.9	43.5	31.5	30.5	18.0	66.0	56.0	3.5	50	46	46	250	250	
BJ-90TOf-S30-M42*2.0		30	M 42x2.0	25.0	27.0	49.9	50.5	37.0	35.5	20.0	76.0	64.0	3.5	60	55	50	160	160	
BJ-90TOf-S38-M48*2.0		38	M 48x2.0	32.0	34.0	55.9	57.5	41.5	40.5	22.0	87.0	72.0	3.5	70	60	60	160	160	

订货示例:

碳钢, 无六价铬镀锌: BJ-90TOe-L06-M10*1.0

304不锈钢: BJ-90TOe-L06-M10*1.0-304

316不锈钢: BJ-90TOe-L06-M10*1.0-316

注: 订货号不含螺母卡套

注: 订货号含螺母卡套 BJ-90TOe-L06-M10*1.0-NBR

BJ-90TOg/BJ-90TOh 90°高压铰接式接头—BSPP英制螺纹

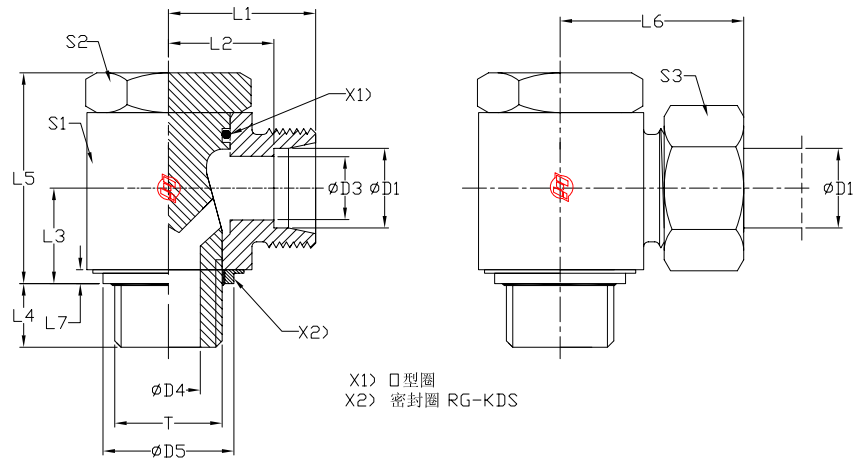

订货号	系列	钢管 外径														PN(bar)		
			D1	T	D3	D4	D5	L1	L2	L3	L4	L5	L6	L7	S1	S2	S3	c
BJ-90TOg-L06-02	L	06	G1/8A	4.0	4.5	14.9	19.0	12.0	10.5	8.0	24.0	27.0	2.5	17	17	14	315	315
BJ-90TOg-L08-04		08	G1/4A	6.0	6.0	18.9	21.5	14.5	14.0	12.0	30.0	29.0	3.0	22	19	17	315	315
BJ-90TOg-L10-04		10	G1/4A	8.0	6.0	18.9	22.5	15.5	14.0	12.0	30.0	30.0	3.0	22	19	19	315	315
BJ-90TOg-L12-06		12	G3/8A	10.0	7.5	21.9	25.0	18.0	16.5	12.0	36.0	33.0	3.0	27	24	22	315	315
BJ-90TOg-L15-08		15	G1/2A	12.0	11.0	26.9	28.5	21.5	21.5	14.0	45.0	37.0	4.5	32	30	27	315	315
BJ-90TOg-L18-08		18	G1/2A	15.0	11.0	26.9	28.5	21.0	21.5	14.0	45.0	37.0	4.5	32	30	32	315	315
BJ-90TOg-L22-12		22	G3/4A	19.0	17.0	32.9	35.0	27.5	24.0	16.0	53.0	44.0	3.5	41	36	36	160	160
BJ-90TOg-L28-16		28	G1 A	24.0	21.0	39.9	39.5	32.0	30.5	18.0	66.0	49.0	3.5	50	46	41	160	160
BJ-90TOg-L35-20		35	G1 1/4A	30.0	27.0	49.9	46.5	36.0	35.5	20.0	76.0	58.0	3.5	60	55	50	160	160
BJ-90TOg-L42-24		42	G1 1/2 A	36.0	34.0	55.9	51.5	40.5	40.5	22.0	87.0	63.0	3.5	70	60	60	160	160
BJ-90TOh-S06-04	S	06	G1/4A	4.0	6.0	18.9	23.5	16.5	14.0	12.0	30.0	31.0	3.0	22	19	17	400	400
BJ-90TOh-S08-04		08	G1/4A	5.0	6.0	18.9	23.5	16.5	14.0	12.0	30.0	31.0	3.0	22	19	19	400	400
BJ-90TOh-S10-06		10	G3/8A	7.0	7.5	21.9	26.0	18.5	16.5	12.0	36.0	35.0	3.0	27	24	22	400	400
BJ-90TOh-S12-06		12	G3/8A	8.0	7.5	21.9	26.0	18.5	16.5	12.0	36.0	35.0	3.0	27	24	24	400	400
BJ-90TOh-S14-08		14	G1/2A	10.0	11.0	26.9	30.5	22.5	21.5	15.0	45.0	40.0	4.5	32	30	27	400	400
BJ-90TOh-S16-08		16	G1/2A	12.0	11.0	26.9	30.5	22.0	21.5	14.0	45.0	40.0	4.5	32	30	30	315	315
BJ-90TOh-S20-12		20	G3/4A	16.0	17.0	32.9	37	26.5	24.0	16.0	53.0	48.0	3.5	41	36	36	315	315
BJ-90TOh-S25-16		25	G1 A	20.0	21.0	39.9	43.5	31.5	30.5	18.0	66.0	56.0	3.5	50	46	46	250	250
BJ-90TOh-S30-20		30	G1 1/4A	25.0	27.0	49.9	50.5	37.0	35.5	20.0	76.0	64.0	3.5	60	55	50	160	160
BJ-90TOh-S38-24		38	G1 1/2A	32.0	34.0	55.9	57.5	41.5	40.5	22.0	87.0	72.0	3.5	70	60	60	160	160

订货示例:

碳钢, 无六价铬镀锌: BJ-90TOg-L06-02

304不锈钢: BJ-90TOg-L06-02-304

316不锈钢: BJ-90TOg-L06-02-316

注: 订货号不含螺母卡套

注: 订货号含螺母卡套 BJ-90TOg-L06-02-NBR

BJ-TTOg/BJ-TTOh 三通高压铰接式接头-英制螺纹

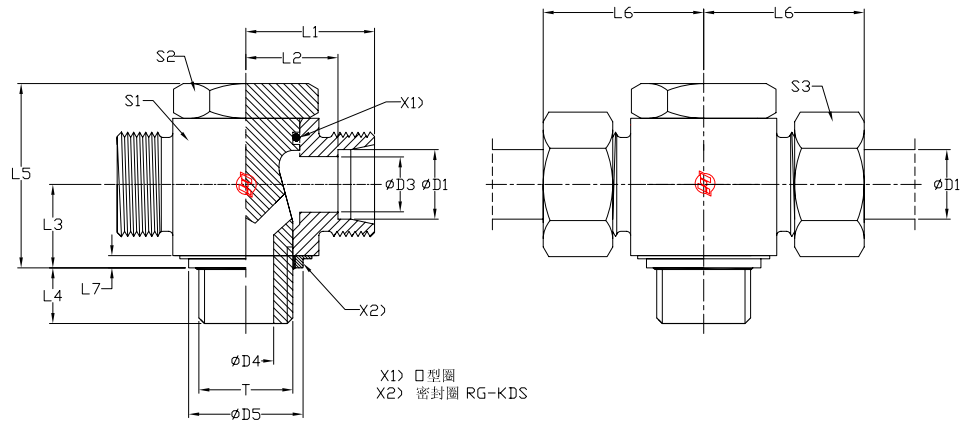

订货代号	系列	钢管 外径		D3	D4	D5										PN(bar)		
		D1	T			KDS	L1	L2	L3	L4	L5	L6	L7	S1	S2	S3	C	SS
BJ-TTOg-L06-L06-02	L	06	G 1/8 A	4.0	4.5	14.9	19.0	12.0	10.5	8.0	24.0	27.0	2.5	17	17	14	315	315
BJ-TTOg-L08-L08-04		08	G 1/4 A	6.0	6.0	18.9	21.5	14.5	14.0	12.0	30.0	29.0	3.0	22	19	17	315	315
BJ-TTOg-L10-L10-04		10	G 1/4 A	8.0	6.0	18.9	22.5	15.5	14.0	12.0	30.0	30.0	3.0	22	19	19	315	315
BJ-TTOg-L12-L12-06		12	G 3/8 A	10.0	7.5	21.9	25.0	18.0	16.5	12.0	36.0	33.0	3.0	27	24	22	315	315
BJ-TTOg-L15-L15-08		15	G 1/2 A	12.0	11.0	26.9	28.5	21.5	21.5	14.0	45.0	37.0	4.5	32	30	27	315	315
BJ-TTOg-L18-L18-08		18	G 1/2 A	15.0	11.0	26.9	28.5	21.0	21.5	14.0	45.0	37.0	4.5	32	30	32	315	315
BJ-TTOg-L22-L22-12		22	G 3/4 A	19.0	17.0	32.9	35.0	27.5	24.0	16.0	53.0	44.0	3.5	41	36	36	160	160
BJ-TTOg-L28-L28-16		28	G 1 A	24.0	21.0	39.9	39.5	32.0	30.5	18.0	66.0	49.0	3.5	50	46	41	160	160
BJ-TTOg-L35-L35-20		35	G 1 1/4 A	30.0	27.0	49.9	46.5	36.0	35.5	20.0	76.0	58.0	3.5	60	55	50	160	160
BJ-TTOg-L42-L42-24		42	G 1 1/2 A	36.0	34.0	55.9	51.5	40.5	40.5	22.0	87.0	63.0	3.5	70	60	60	160	160
BJ-TTOh-S06-S06-04	S	06	G 1/4 A	4.0	6.0	18.9	23.5	16.5	14.0	12.0	30.0	31.0	3.0	22	19	17	400	400
BJ-TTOh-S08-S08-04		08	G 1/4 A	5.0	6.0	18.9	23.5	16.5	14.0	12.0	30.0	31.0	3.0	22	19	19	400	400
BJ-TTOh-S10-S10-06		10	G 3/8 A	7.0	7.5	21.9	26.0	18.5	16.5	12.0	36.0	35.0	3.0	27	24	22	400	400
BJ-TTOh-S12-S12-06		12	G 3/8 A	8.0	7.5	21.9	26.0	15.5	16.5	12.0	36.0	35.0	3.0	27	24	24	400	400
BJ-TTOh-S14-S14-08		14	G 1/2 A	10.0	11.0	26.9	30.5	22.5	21.5	15.0	45.0	40.0	4.5	32	30	27	400	400
BJ-TTOh-S16-S16-08		16	G 1/2 A	12.0	11.0	26.9	30.5	22.0	21.5	14.0	45.0	40.0	4.5	32	30	30	315	315
BJ-TTOh-S20-S20-12		20	G 3/4 A	16.0	17.0	32.9	37.0	26.5	24.0	16.0	53.0	48.0	3.5	41	36	36	315	315
BJ-TTOh-S25-S25-16		25	G 1 A	20.0	21.0	39.9	43.5	31.5	30.5	18.0	66.0	56.0	3.5	50	46	46	250	250
BJ-TTOh-S30-S30-20		30	G 1 1/4 A	25.0	27.0	49.9	50.5	37.0	35.5	20.0	76.0	64.0	3.5	60	55	50	160	160
BJ-TTOh-S38-S38-24		38	G 1 1/2 A	32.0	34.0	55.9	57.5	41.5	40.5	22.0	87.0	72.0	3.5	70	60	60	160	160

订货示例:

碳钢, 无六价铬镀锌: BJ-TTOg-L06-L06-02

304不锈钢: BJ-TTOg-L06-L06-02-304

316不锈钢: BJ-TTOg-L06-L06-02-316

注: 订货号不含螺母卡套

注: 订货号含螺母卡套 BJ-TTOg-L06-L06-02-NBR

BJ-TTOe/BJ-TTOf 三通高压铰接式接头—公制螺纹

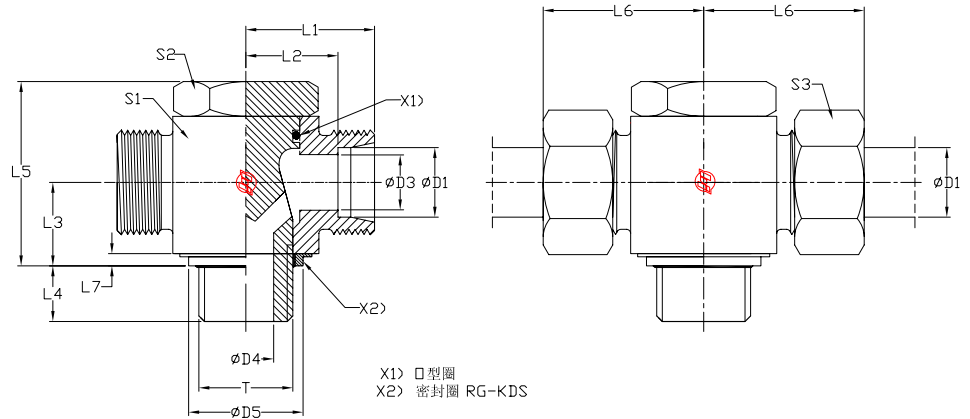

订货代号	系列	钢管 外径		D5													PN(bar)	
		D1	T	D3	D4	KDS	L1	L2	L3	L4	L5	L6	L7	S1	S2	S3	C	SS
BJ-TTOe-L06-L06-M10*1.0	L	06	M10*1.0	4.0	4.5	14.9	19.0	12.0	10.5	8.0	24.0	27.0	2.5	17	17	14	315	315
BJ-TTOe-L08-L08-M12*1.5		08	M12*1.5	6.0	6.0	17.0	21.5	14.5	14.0	12.0	30.0	29.0	3.0	22	19	17	315	315
BJ-TTOe-L10-L10-M14*1.5		10	M14*1.5	8.0	6.0	18.9	22.5	15.5	14.0	12.0	30.0	30.0	3.0	22	19	19	315	315
BJ-TTOe-L12-L12-M16*1.5		12	M16*1.5	10.0	7.5	21.9	25.0	18.0	16.5	12.0	36.0	33.0	3.0	27	24	22	315	315
BJ-TTOe-L15-L15-M18*1.5		15	M18*1.5	11.0	9.0	23.9	27.5	21.5	18.5	12.0	39.5	37.0	3.0	30	27	27	315	315
BJ-TTOe-L18-L18-M22*1.5		18	M22*1.5	15.0	12.0	26.9	28.5	21.0	21.5	14.0	45.0	37.0	4.5	32	30	32	315	315
BJ-TTOe-L22-L22-M26*1.5		22	M26*1.5	19.0	17.0	31.9	35.0	27.5	24.0	16.0	53.0	44.0	3.5	41	36	36	160	160
BJ-TTOe-L28-L28-M33*2.0		28	M33*2.0	24.0	21.0	39.9	39.5	32.0	30.5	18.0	66.0	49.0	3.5	50	46	41	160	160
BJ-TTOe-L35-L35-M42*2.0		35	M42*2.0	30.0	27.0	49.9	46.5	36.0	35.5	20.0	76.0	58.0	3.5	60	55	50	160	160
BJ-TTOe-L42-L42-M48*2.0		42	M48*2.0	36.0	34.0	55.9	51.5	40.5	40.5	22.0	87.0	63.0	3.5	70	60	60	160	160
BJ-TTOf-S06-S06-M12*1.5	S	06	M12*1.5	4.0	6.0	17.0	23.5	16.5	14.0	12.0	30.0	31.0	3.0	22	19	17	400	400
BJ-TTOf-S08-S08-M14*1.5		08	M14*1.5	5.0	6.0	18.9	23.5	16.5	14.0	12.0	30.0	31.0	3.0	22	19	19	400	400
BJ-TTOf-S10-S10-M16*1.5		10	M16*1.5	7.0	7.5	21.9	26.0	18.5	16.5	12.0	36.0	35.0	3.0	27	24	22	400	400
BJ-TTOf-S12-S12-M18*1.5		12	M18*1.5	8.0	9.0	23.9	27.5	20.0	18.5	12.0	39.5	36.0	3.0	27	27	24	400	400
BJ-TTOf-S14-S14-M20*1.5		14	M20*1.5	10.0	10.0	24.9	30.5	22.5	20.0	14.0	43.5	40.0	3.0	32	30	27	400	400
BJ-TTOf-S16-S16-M22*1.5		16	M22*1.5	12.0	12.0	26.9	30.5	22.0	21.5	14.0	45.0	40.0	4.5	32	30	30	315	315
BJ-TTOf-S20-S20-M27*2.0		20	M27*2.0	16.0	16.0	32.9	37.0	26.5	24.0	16.0	53.0	48.0	3.5	41	36	36	315	315
BJ-TTOf-S25-S25-M33*2.0		25	M33*2.0	20.0	21.0	39.9	43.5	31.5	30.5	18.0	66.0	56.0	3.5	50	46	46	250	250
BJ-TTOf-S30-S30-M42*2.0		30	M42*2.0	25.0	27.0	49.9	50.5	37.0	35.5	20.0	76.0	64.0	3.5	60	55	50	160	160
BJ-TTOf-S38-S38-M48*2.0		38	M48*2.0	32.0	34.0	55.9	57.5	41.5	40.5	22.0	87.0	72.0	3.5	70	60	60	160	160

订货示例:

碳钢, 无六价铬镀锌: BJ-TTOe-L06-L06-M10*1.0

304不锈钢: BJ-TTOe-L06-L06-M10*1.0-304

316不锈钢: BJ-TTOe-L06-L06-M10*1.0-316

注: 订货号不含螺母卡套

注: 订货号含螺母卡套 BJ-TTOe-L06-L06-M10*1.0-NBR

90TR 非调向接头—BSPT锥管螺纹

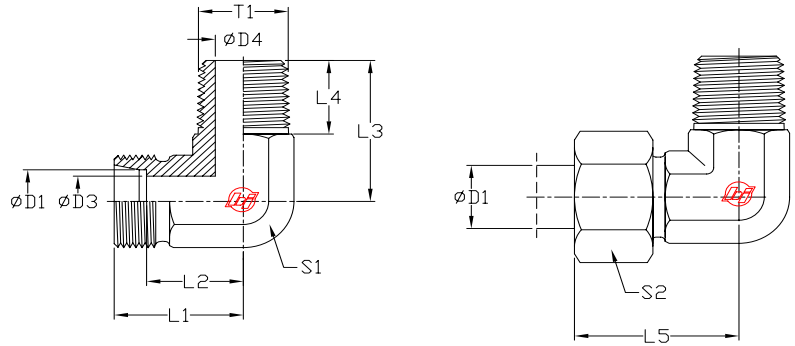

订货号	系列	钢管 外径													PN(bar)	
		D1	T1	D3	D4	L1	L2	L3	L4	L5	S1	S2	S3	C	SS	
90TR-LL04-02	LL	04	R1/8	3.0	4.0	15.0	11.0	17.0	8.0	21.0	9	10	11	100	100	
90TR-LL06-02		06	R1/8	4.5	4.5	15.0	9.5	17.0	8.0	21.0	9	12	11	100	100	
90TR-LL08-02		08	R1/8	6.0	6.0	17.0	11.5	20.0	8.0	23.0	12	14	12	100	100	
90TR-LL10-04		10	R1/4	8.0	7.0	18.0	12.5	23.0	12.0	24.0	12	17	14	100	100	
90TR-LL12-04		12	R1/4	10.0	7.0	19.0	13.0	23.0	12.0	25.0	14	19	17	100	100	
90TR-L06-02	L	06	R1/8	4.0	4.0	19.0	12.0	20.0	8.0	27.0	12	14	12	315	315	
90TR-L06-04		06	R1/4	4.0	6.0	21.0	14.0	26.0	12.0	29.0	12	14	14	315	315	
90TR-L08-04		08	R1/4	6.0	6.0	21.0	14.0	26.0	12.0	29.0	12	17	14	315	315	
90TR-L08-02		08	R1/8	6.0	4.0	21.0	14.0	26.0	8.0	29.0	12	17	14	315	315	
90TR-L08-06		08	R3/8	6.0	9.0	24.0	17.0	28.0	12.0	32.0	17	17	19	315	315	
90TR-L10-04		10	R1/4	8.0	7.0	22.0	15.0	27.0	12.0	30.0	14	19	17	315	315	
90TR-L10-06		10	R3/8	8.0	9.0	24.0	17.0	28.0	12.0	32.0	17	19	19	315	315	
90TR-L12-06		12	R3/8	10.0	9.0	24.0	17.0	28.0	12.0	32.0	17	22	19	315	315	
90TR-L12-04		12	R1/4	10.0	7.0	24.0	17.0	27.0	12.0	32.0	17	22	19	315	315	
90TR-L12-08		12	R1/2	10.0	11.0	28.0	21.0	34.0	14.0	36.0	19	22	—	315	315	
90TR-L15-08	15	R1/2	12.0	11.0	28.0	21.0	34.0	14.0	36.0	19	27	—	315	315		
90TR-L18-08	18	R1/2	15.0	14.0	31.0	23.5	36.0	14.0	40.0	24	32	—	315	315		
90TR-S06-04	S	06	R1/4	4.0	4.0	23.0	16.0	26.0	12.0	31.0	12	17	14	400	400	
90TR-S06-06		06	R3/8	4.0	7.0	25.0	18.0	28.0	12.0	33.0	17	17	19	400	400	
90TR-S08-04		08	R1/4	5.0	5.0	24.0	17.0	27.0	12.0	32.0	14	19	17	400	400	
90TR-S08-06		08	R3/8	5.0	7.0	25.0	18.0	28.0	12.0	33.0	17	19	19	400	400	
90TR-S10-06		10	R3/8	7.0	7.0	25.0	17.5	28.0	12.0	34.0	17	22	19	400	400	
90TR-S10-04		10	R1/4	7.0	5.0	25.0	17.5	28.0	12.0	34.0	17	22	19	400	400	
90TR-S10-08		10	R1/2	7.0	10.0	30.0	22.5	32.0	14.0	39.0	19	22	—	400	400	
90TR-S12-06		12	R3/8	8.0	8.0	29.0	21.5	28.0	12.0	38.0	17	24	22	400	400	
90TR-S12-08		12	R1/2	8.0	11.0	30.0	22.5	32.0	14.0	39.0	19	24	—	400	400	
90TR-S14-08		14	R1/2	10.0	10.0	30.0	22.0	32.0	14.0	40.0	19	27	—	400	400	
90TR-S16-08	16	R1/2	12.0	12.0	33.0	24.5	32.0	14.0	43.0	24	30	—	400	400		

订货示例:

碳钢, 无六价铬镀锌: 90TR-L06-02

304不锈钢: 90TR-L06-02-304

316不锈钢: 90TR-L06-02-316

注: 订货号不含螺母卡套

注: 订货号含螺母卡套 90TR-L06-02-NBR

90TP 非调向接头—NPT锥管螺纹

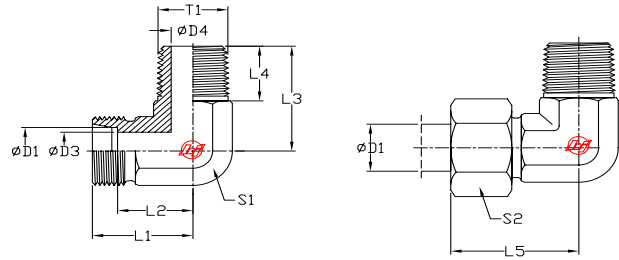

订货号	系列	钢管 外径	T1	D3	D4	L1	L2	L3	L4	L5	S1	S2	PN(bar)		
		D1											C	SS	
90TP-LL04-02	LL	04	1/8-27 NPT	3.0	4.0	15.0	11.0	17.0	10.0	21.0	9	10	100	100	
90TP-LL06-02		06	1/8-27 NPT	4.5	4.5	15.0	9.5	17.0	10.0	21.0	9	12	100	100	
90TP-LL08-02		08	1/8-27 NPT	6.0	5.0	17.0	11.5	20.0	10.0	23.0	12	14	100	100	
90TP-L06-02	L	06	1/8-27 NPT	4.0	4.0	19.0	12.0	20.0	10.0	27.0	12	14	315	315	
90TP-L06-04		06	1/4-18 NPT	4.0	7.0	21.0	14.0	26.0	14.5	29.0	12	14	315	315	
90TP-L06-06		06	3/8-18 NPT	4.0	8.0	25.0	18.0	28.0	14.5	33.0	17	14	315	315	
90TP-L08-02		08	1/8-27 NPT	6.0	4.0	21.0	14.0	26.0	10.0	29.0	12	17	315	315	
90TP-L08-04		08	1/4-18 NPT	6.0	6.0	21.0	14.0	26.0	14.5	29.0	12	17	315	315	
90TP-L10-04		10	1/4-18 NPT	8.0	7.0	22.0	15.0	27.0	14.5	30.0	14	19	315	315	
90TP-L10-06		10	3/8-18 NPT	8.0	8.0	24.0	17.0	28.0	14.5	32.0	17	19	315	315	
90TP-L12-04		12	1/4-18 NPT	10.0	7.0	24.0	17.0	28.0	14.5	32.0	17	22	315	315	
90TP-L12-06		12	3/8-18 NPT	10.0	8.0	24.0	17.0	28.0	14.5	32.0	17	22	315	315	
90TP-L12-08		12	1/2-14 NPT	10.0	11.0	28.0	21.0	34.0	19.5	36.0	19	22	315	315	
90TP-L15-08		15	1/2-14 NPT	12.0	11.0	28.0	21.0	34.0	19.5	36.0	19	27	315	315	
90TP-L18-08		18	1/2-14 NPT	15.0	12.0	31.0	23.5	36.0	19.5	40.0	24	32	315	315	
90TP-L22-12		22	3/4-14 NPT	19.0	16.0	35.0	27.5	42.0	19.5	44.0	27	36	160	160	
90TP-L28-16		28	1-11.5 NPT	24.0	21.0	38.0	30.5	48.0	24.5	47.0	36	41	160	160	
90TP-L35-20		35	1 1/4-11.5 NPT	30.0	28.0	45.0	34.5	54.0	25.0	56.0	41	50	160	160	
90TP-L42-24		42	1 1/2-11.5 NPT	36.0	34.0	51.0	40.0	61.0	26.0	63.0	50	60	160	160	
90TP-S06-04		S	06	1/4-18 NPT	4.0	4.0	23.0	16.0	26.0	14.5	31.0	12	17	630	630
90TP-S08-04			08	1/4-18 NPT	5.0	5.0	24.0	17.0	27.0	14.5	32.0	14	19	630	630
90TP-S08-06			08	3/8-18 NPT	5.0	8.0	25.0	18.0	28.0	14.5	33.0	17	19	630	630
90TP-S08-08			08	1/2-14 NPT	5.0	10.0	30.0	23.0	34.0	19.5	38.0	19	19	630	630
90TP-S10-04	10		1/4-18 NPT	7.0	5.0	25.0	17.5	28.0	14.5	34.0	17	22	630	630	
90TP-S10-06	10		3/8-18 NPT	7.0	7.0	25.0	17.5	28.0	14.5	34.0	17	22	630	630	
90TP-S12-04	12		1/4-18 NPT	8.0	5.0	29.0	21.5	29.0	14.5	38.0	17	24	630	630	
90TP-S12-06	12		3/8-18 NPT	8.0	8.0	29.0	22.5	28.0	14.5	38.0	17	24	630	630	
90TP-S12-08	12		1/2-14 NPT	8.0	10.0	30.0	22.5	34.0	19.5	39.0	19	24	630	630	
90TP-S14-08	14		1/2-14 NPT	10.0	10.0	30.0	22.0	34.0	19.5	40.0	19	27	630	630	
90TP-S16-08	16		1/2-14 NPT	12.0	12.0	33.0	24.5	36.0	19.5	43.0	24	30	400	400	
90TP-S20-12	20		3/4-14 NPT	16.0	16.0	37.0	26.5	42.0	19.5	48.0	27	36	400	400	
90TP-S25-16	25		1-11.5 NPT	20.0	20.0	42.0	30.0	48.0	24.5	54.0	36	46	400	400	
90TP-S30-20	30		1 1/4-11.5 NPT	25.0	25.0	49.0	35.5	54.0	25.0	62.0	41	50	400	400	
90TP-S38-24	38		1 1/2-11.5 NPT	32.0	32.0	57.0	41.0	61.0	26.0	72.0	50	60	315	315	

订货示例:

碳钢,无六价铬镀锌:90TP-L06-02

304不锈钢:90TP-L06-02-304

316不锈钢:90TP-L06-02-316

注:订货号不含螺母卡套

注:订货号含螺母卡套90TP-L06-02-NBR

00TXm 直通内螺纹连接—公制螺纹

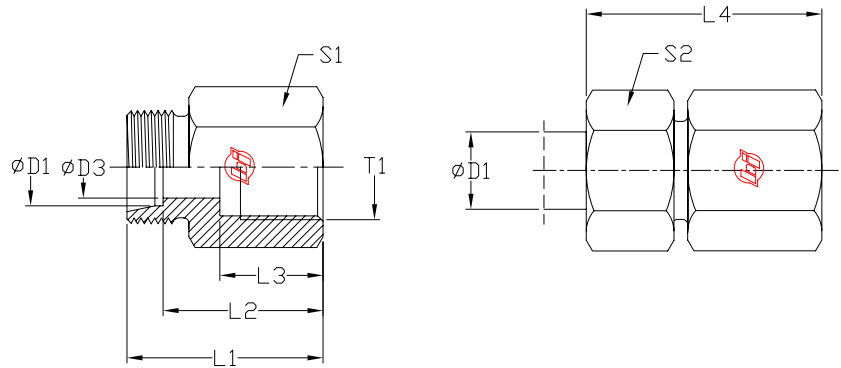

订货号	系列	钢管 外径	T1	D3	L1	L2	L3	L4	S1	S2	PN(bar)	
		D1									C	SS
00TXm-L06-M10*1.0	L	06	M10x1.0	4.0	26.5	19.5	12.5	34.0	14	14	315	315
00TXm-L08-M12*1.5		08	M12x1.5	6.0	31.0	24.0	17.0	39.0	17	17	315	315
00TXm-L10-M14*1.5		10	M14x1.5	8.0	32.0	25.0	17.0	40.0	19	19	315	315
00TXm-L12-M16*1.5		12	M16x1.5	10.0	33.0	26.0	17.0	41.0	22	22	315	315
00TXm-L15-M18*1.5		15	M18x1.5	12.0	35.0	28.0	17.0	43.0	24	27	315	315
00TXm-L18-M22*1.5		18	M22x1.5	15.0	37.0	29.5	19.0	46.0	30	32	315	315
00TXm-L22-M26*1.5		22	M26x1.5	19.0	42.0	34.5	21.0	51.0	32	36	160	160
00TXm-L28-M33*2		28	M33x2.0	24.0	45.0	37.5	24.0	54.0	41	41	160	160
00TXm-L35-M42*2		35	M42x2.0	30.0	51.0	40.5	26.0	62.0	55	50	160	160
00TXm-L42-M48*2		42	M48x2.0	36.0	53.0	42.0	28.0	65.0	60	60	160	160
00TXm-S06-M12*1.5	S	06	M12x1.5	4.0	33.0	26.0	17.0	41.0	17	17	400	400
00TXm-S08-M14*1.5		08	M14x1.5	5.0	33.0	26.0	17.0	41.0	17	19	400	400
00TXm-S10-M16*1.5		10	M16x1.5	7.0	34.0	26.5	17.0	43.0	22	22	400	400
00TXm-S12-M18*1.5		12	M18x1.5	8.0	35.0	27.5	17.0	44.0	24	24	400	400
00TXm-S16-M22*1.5		16	M22x1.5	12.0	39.0	30.5	19.0	49.0	30	30	400	400
00TXm-S20-M27*2.0		20	M27x2.0	16.0	45.0	34.5	22.0	56.0	36	36	315	315
00TXm-S25-M33*2.0		25	M33x2.0	20.0	49.0	37.0	24.0	61.0	41	46	315	315
00TXm-S30-M42*2.0		30	M42x2.0	25.0	55.0	41.5	26.0	68.0	55	50	315	315
00TXm-S38-M48*2.0		38	M48x2.0	32.0	59.0	43.0	28.0	74.0	60	60	250	250

订货示例:

碳钢, 无六价铬镀锌: 00TXm-L06-M10x1.0

304不锈钢: 00TXm-L06-M10x1.0-304

316不锈钢: 00TXm-L06-M10x1.0-316

注: 订货号不含螺母卡套

注: 订货号含螺母卡套 00TXm-L06-M10x1.0-NBR

00TXg 直通内螺纹连接—BSP英制螺纹

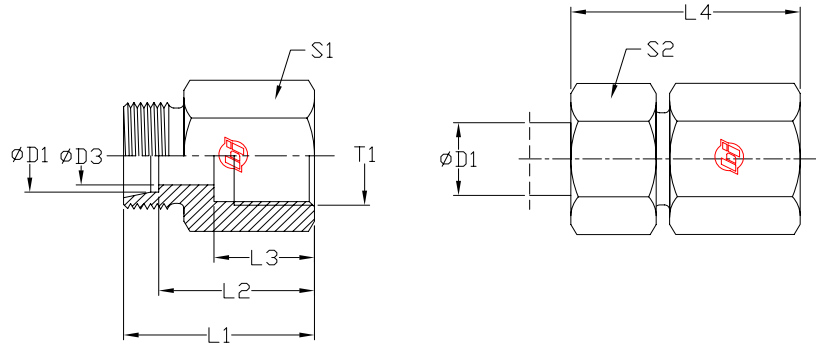

订货号	系列	钢管 外径		T1	D3	L1	L2	L3	L4	S1	S2	PN(bar)	
		D1										C	SS
00TXg-L06-02	L	06		G1/8	4.0	26.0	19.0	12.0	34.0	14	14	315	315
00TXg-L06-04		06		G1/4	4.0	31.0	24.0	17.0	39.0	19	14	315	315
00TXg-L08-04		08		G1/4	6.0	31.0	24.0	17.0	39.0	19	17	315	315
00TXg-L08-06		08		G3/8	6.0	32.0	25.0	17.0	40.0	24	17	315	315
00TXg-L08-08		08		G1/2	6.0	36.0	29.0	20.0	44.0	27	17	315	315
00TXg-L10-04		10		G1/4	8.0	32.0	25.0	17.0	40.0	19	19	315	315
00TXg-L10-06		10		G3/8	8.0	33.0	26.0	17.0	41.0	24	19	315	315
00TXg-L10-08		10		G1/2	8.0	37.0	30.0	20.0	45.0	27	19	315	315
00TXg-L12-06		12		G3/8	10.0	33.0	26.0	17.0	41.0	24	22	315	315
00TXg-L12-08		12		G1/2	10.0	37.0	30.0	20.0	45.0	27	22	315	315
00TXg-L15-08		15		G1/2	12.0	38.0	31.0	20.0	46.0	27	27	315	315
00TXg-L18-08		18		G1/2	15.0	38.0	30.5	20.0	47.0	27	32	315	315
00TXg-L18-06		18		G3/8	15.0	34.0	26.5	17.0	43.0	27	32	315	315
00TXg-L22-12		22		G3/4	19.0	43.0	35.5	22.0	52.0	36	36	160	160
00TXg-L28-16		28		G1	24.0	45.5	38.0	24.5	55.0	41	41	160	160
00TXg-L35-20		35		G1 1/4	30.0	51.5	41.0	26.5	63.0	55	50	160	160
00TXg-L42-24	42		G1 1/2	36.0	53.5	42.5	28.5	65.0	60	60	160	160	
00TXg-S06-04	S	06		G1/4	4.0	33.0	26.0	17.0	41.0	19	17	400	400
00TXg-S08-04		08		G1/4	5.0	33.0	26.0	17.0	41.0	19	19	400	400
00TXg-S10-06		10		G3/8	7.0	34.0	26.5	17.0	43.0	24	22	400	400
00TXg-S12-06		12		G3/8	8.0	34.0	26.5	17.0	43.0	24	24	400	400
00TXg-S12-08		12		G1/2	8.0	38.0	30.5	20.0	47.0	30	24	400	400
00TXg-S16-08		16		G1/2	12.0	40.0	31.5	20.0	50.0	30	30	400	400
00TXg-S20-12		20		G3/4	16.0	45.0	34.5	22.0	56.0	36	36	315	315
00TXg-S25-16		25		G1	20.0	49.5	37.5	24.5	62.0	41	46	315	315
00TXg-S30-20		30		G1 1/4	25.0	55.5	42.0	26.5	69.0	55	50	315	315
00TXg-S38-24		38		G1 1/2	32.0	59.5	43.5	28.5	74.0	60	60	250	250

订货示例:

碳钢, 无六价铬镀锌: 00TXg-L06-02

304不锈钢: 00TXg-L06-02-304

316不锈钢: 00TXg-L06-02-316

注: 订货号不含螺母卡套

注: 订货号含螺母卡套 00TXg-L06-02-NBR

00TG 直通内螺纹连接—NPT锥管螺纹

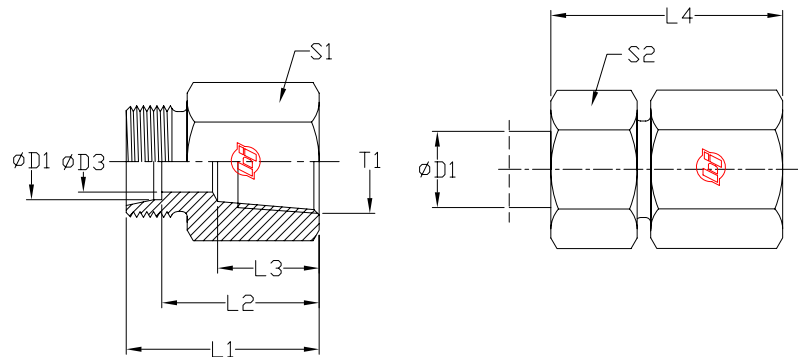

订货号	系列	钢管 外径 D1	T1	D3	L1	L2	L3	L4	S1	S2	PN(bar)	
											C	SS
00TG-L06-02	L	06	1/8-27NPT	4.0	26.0	19.0	11.6	34.0	14	14	315	315
00TG-L06-04		06	1/4-18NPT	4.0	30.5	23.5	16.4	38.0	19	14	315	315
00TG-L08-04		08	1/4-18NPT	6.0	30.5	23.5	16.4	38.0	19	17	315	315
00TG-L10-04		10	1/4-18NPT	8.0	31.0	24.0	16.4	39.0	19	19	315	315
00TG-L12-06		12	3/8-18NPT	10.0	34.0	27.0	17.4	42.0	24	22	315	315
00TG-L12-08		12	1/2-14NPT	10.0	39.0	32.0	22.6	47.0	27	22	315	315
00TG-L15-08		15	1/2-14NPT	12.0	40.0	33.0	22.6	48.0	27	27	315	315
00TG-L18-08		18	1/2-14NPT	15.0	40.0	32.5	22.6	49.0	27	32	315	315
00TG-L22-12		22	3/4-14NPT	19.0	43.0	35.5	23.1	52.0	36	36	160	160
00TG-L28-16		28	1-11.5 NPT	24.0	48.0	40.5	27.8	57.0	41	41	160	160
00TG-L35-20		35	1 1/4-11.5NPT	30.0	51.0	40.5	28.3	62.0	55	50	160	160
00TG-L42-24		42	1 1/2-11.5NPT	36.0	53.0	42.0	28.3	65.0	60	60	160	160
00TG-S06-02	S	06	1/8-27NPT	4.0	29.0	22.0	11.6	36.0	14	17	400	400
00TG-S06-04		06	1/4-18NPT	4.0	33.0	26.0	16.4	41.0	19	17	400	400
00TG-S08-04		08	1/4-18NPT	5.0	33.0	26.0	16.4	41.0	19	19	400	400
00TG-S10-06		10	3/8-18NPT	7.0	35.0	27.0	17.4	44.0	24	22	400	400
00TG-S12-04		12	1/4-18NPT	8.0	32.5	25.0	16.4	41.0	22	24	400	400
00TG-S12-06		12	3/8-18NPT	8.0	35.0	27.5	17.4	44.0	24	24	400	400
00TG-S12-08		12	1/2-14NPT	8.0	41.0	33.5	22.6	50.0	27	24	400	400
00TG-S14-08		14	1/2-14NPT	10.0	43.0	35.0	22.6	53.0	27	27	400	400
00TG-S16-08		16	1/2-14NPT	12.0	43.0	34.5	22.6	50.0	27	30	400	400
00TG-S20-08		20	1/2-14NPT	16.0	44.0	33.5	22.6	55.0	32	36	315	315
00TG-S20-12		20	3/4-14NPT	16.0	46.0	35.5	23.1	57.0	36	36	315	315
00TG-S25-16		25	1-11.5NPT	20.0	53.0	41.0	27.8	65.0	41	46	315	315
00TG-S30-20		30	1 1/4-11.5NPT	25.0	57.0	43.5	28.3	70.0	55	50	315	315
00TG-S38-24		38	1 1/2-11.5NPT	32.0	59.0	43.0	28.3	74.0	60	60	250	250

订货示例:

碳钢, 无六价铬镀锌: 00TG-L06-02

304不锈00TG-L06-02-304

316不锈00TG-L06-02-316

注: 订货号不含螺母卡套

注: 订货号含螺母卡套00TG-L06-02-NBR

000gXg 油口变径接头—英制ED密封

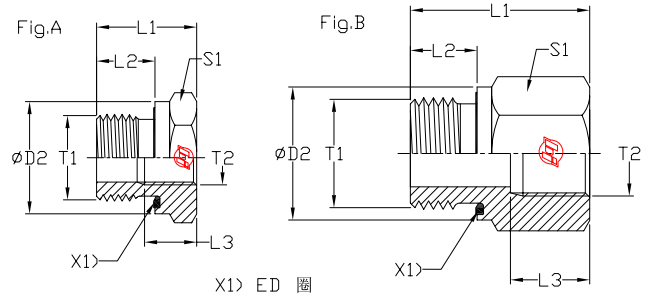

订货号	外螺纹 T1	内螺纹 T2	D2	L1	L2	L3	S1	Fig	PN(bar)	
									C	SS
000gXg-02-04	G1/8A	G1/4	14.0	31.0	8.0	17.0	19	B	400	400
000gXg-02-06	G1/8A	G3/8	14.0	32.0	8.0	17.0	24	B	400	400
000gXg-04-02	G1/4A	G1/8	19.0	29.0	12.0	12.0	19	B	400	400
000gXg-04-06	G1/4A	G3/8	19.0	36.0	12.0	17.0	24	B	400	400
000gXg-04-08	G1/4A	G1/2	19.0	40.0	12.0	20.0	30	B	400	400
000gXg-04-12	G1/4A	G3/4	19.0	43.0	12.0	22.0	36	B	400	400
000gXg-06-02	G3/8A	G1/8	22.0	22.5	12.0	8.0	22	A	400	400
000gXg-06-04	G3/8A	G1/4	22.0	36.0	12.0	17.0	22	B	400	400
000gXg-06-08	G3/8A	G1/2	22.0	41.0	12.0	20.0	30	B	400	400
000gXg-06-12	G3/8A	G3/4	22.0	44.0	12.0	22.0	36	B	315	315
000gXg-08-02	G1/2A	G1/8	27.0	24.0	14.0	8.0	27	A	400	400
000gXg-08-04	G1/2A	G1/4	27.0	24.0	14.0	12.0	27	A	400	400
000gXg-08-06	G1/2A	G3/8	27.0	37.0	14.0	17.0	27	B	400	400
000gXg-08-12	G1/2A	G3/4	27.0	46.0	14.0	22.0	36	B	315	315
000gXg-08-16	G1/2A	G1	27.0	49.0	14.0	24.5	41	B	315	315
000gXg-08-20	G1/2A	G1 1/4	27.0	53.0	14.0	26.5	55	B	315	315
000gXg-12-04	G3/4A	G1/4	32.0	26.0	16.0	12.0	32	A	315	315
000gXg-12-06	G3/4A	G3/8	32.0	26.0	16.0	12.0	32	A	315	315
000gXg-12-08	G3/4A	G1/2	32.0	43.0	16.0	20.0	32	B	315	315
000gXg-12-16	G3/4A	G1	32.0	51.0	16.0	24.5	41	B	315	315
000gXg-12-20	G3/4A	G1 1/4	32.0	55.0	16.0	26.5	55	B	315	315
000gXg-12-24	G3/4A	G1 1/2	32.0	57.0	16.0	28.5	60	B	250	250
000gXg-16-04	G1 A	G1/4	40.0	29.0	18.0	12.0	41	A	315	315
000gXg-16-06	G1 A	G3/8	40.0	29.0	18.0	12.0	41	A	315	315
000gXg-16-08	G1 A	G1/2	40.0	29.0	18.0	14.0	41	A	315	315
000gXg-16-12	G1 A	G3/4	40.0	49.0	18.0	22.0	41	B	315	315
000gXg-16-20	G1 A	G1 1/4	40.0	57.0	18.0	26.5	55	B	315	315
000gXg-16-24	G1 A	G1 1/2	40.0	59.0	18.0	28.5	60	B	250	250
000gXg-20-08	G1 1/4 A	G1/2	50.0	32.0	20.0	14.0	50	A	315	315
000gXg-20-12	G1 1/4 A	G3/4	50.0	32.0	20.0	16.0	50	A	315	315
000gXg-20-16	G1 1/4 A	G1	50.0	52.0	20.0	24.5	50	B	315	315
000gXg-20-24	G1 1/4 A	G1 1/2	50.0	60.0	20.0	28.5	60	B	250	250
000gXg-24-08	G1 1/2 A	G1/2	55.0	36.0	22.0	14.0	55	A	250	250
000gXg-24-12	G1 1/2 A	G3/4	55.0	36.0	22.0	16.0	55	A	250	250
000gXg-24-16	G1 1/2 A	G1	55.0	36.0	22.0	18.0	55	A	250	250
000gXg-24-20	G1 1/2 A	G1 1/4	55.0	58.0	22.0	26.5	55	B	250	250
000gXg-32-24	G2A	G1 1/2	75.0	65.0	24.0	28.5	75	B	160	110

订货示例:

碳钢, 无六价铬镀锌: 000gXg-02-04

304不锈钢: 000gXg-02-04-304

316不锈钢: 000gXg-02-04-316

00LbXg 油口变径接头—英制金属密封

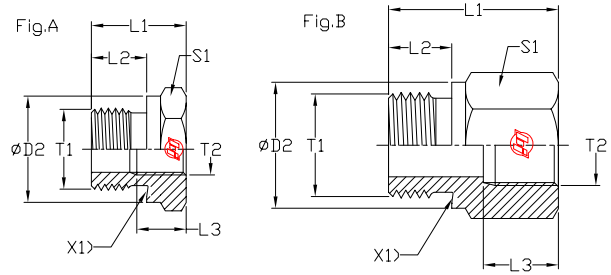

订货号	外螺纹	内螺纹	D2	L1	L2	L3	S1	Fig	PN(bar)	
	T1	T2							C	SS
00LbXg-02-04	G1/8A	G1/4	14.0	31.0	8.0	17.0	19	B	400	400
00LbXg-02-06	G1/8A	G3/8	14.0	32.0	8.0	17.0	24	B	400	400
00LbXg-04-02	G1/4A	G1/8	18.0	28.0	12.0	12.0	19	B	400	400
00LbXg-04-06	G1/4A	G3/8	18.0	36.0	12.0	17.0	24	B	400	400
00LbXg-04-08	G1/4A	G1/2	18.0	40.0	12.0	20.0	30	B	400	400
00LbXg-04-12	G1/4A	G3/4	18.0	43.0	12.0	22.0	36	B	315	315
00LbXg-06-02	G3/8A	G1/8	22.0	22.5	12.0	8.0	22	A	400	400
00LbXg-06-04	G3/8A	G1/4	22.0	36.0	12.0	17.0	22	B	400	400
00LbXg-06-08	G3/8A	G1/2	22.0	41.0	12.0	20.0	30	B	400	400
00LbXg-06-12	G3/8A	G3/4	22.0	44.0	12.0	22.0	36	B	315	315
00LbXg-08-02	G1/2A	G1/8	26.0	24.0	14.0	8.0	27	A	400	400
00LbXg-08-04	G1/2A	G1/4	26.0	24.0	14.0	12.0	27	A	315	315
00LbXg-08-06	G1/2A	G3/8	26.0	36.0	14.0	17.0	27	B	315	315
00LbXg-08-12	G1/2A	G3/4	26.0	46.0	14.0	22.0	36	B	315	315
00LbXg-08-16	G1/2A	G1	26.0	49.0	14.0	24.5	41	B	315	315
00LbXg-08-20	G1/2A	G1 1/4	26.0	53.0	14.0	26.5	55	B	160	160
00LbXg-12-04	G3/4A	G1/4	32.0	26.0	16.0	12.0	32	A	315	315
00LbXg-12-06	G3/4A	G3/8	32.0	26.0	16.0	12.0	32	A	315	315
00LbXg-12-08	G3/4A	G1/2	32.0	41.0	16.0	20.0	32	B	315	315
00LbXg-12-16	G3/4A	G1	32.0	51.0	16.0	24.5	41	B	315	315
00LbXg-12-20	G3/4A	G1 1/4	32.0	55.0	16.0	26.5	55	B	160	160
00LbXg-12-24	G3/4A	G1 1/2	32.0	57.0	16.0	28.5	60	B	160	160
00LbXg-16-04	G1 A	G1/4	39.0	29.0	18.0	12.0	41	A	315	315
00LbXg-16-06	G1 A	G3/8	39.0	29.0	18.0	12.0	41	A	315	315
00LbXg-16-08	G1 A	G1/2	39.0	29.0	18.0	14.0	41	A	315	315
00LbXg-16-12	G1 A	G3/4	39.0	47.0	18.0	22.0	41	B	315	315
00LbXg-16-20	G1 A	G1 1/4	39.0	57.0	18.0	26.5	55	B	160	160
00LbXg-16-24	G1 A	G1 1/2	39.0	59.0	18.0	28.5	60	B	160	160
00LbXg-20-08	G1 1/4A	G1/2	49.0	32.0	20.0	14.0	50	A	160	160
00LbXg-20-12	G1 1/4 A	G3/4	49.0	32.0	20.0	16.0	50	A	160	160
00LbXg-20-16	G1 1/4A	G1	49.0	52.0	20.0	24.5	50	B	160	160
00LbXg-20-24	G1 1/4A	G1 1/2	49.0	60.0	20.0	28.5	60	B	160	160
00LbXg-24-08	G1 1/2 A	G1/2	55.0	36.0	22.0	14.0	55	A	160	160
00LbXg-24-12	G1 1/2 A	G3/4	55.0	36.0	22.0	16.0	55	A	160	160
00LbXg-24-16	G1 1/2 A	G1	55.0	36.0	22.0	18.0	55	A	160	160
00LbXg-24-20	G1 1/2 A	G1 1/4	55.0	58.0	22.0	26.5	55	B	160	160
00LbXg-32-24	G2A	G1 1/2	68.0	62.0	24.0	28.5	70	B	160	160

订货示例:

碳钢, 无六价铬镀锌: 00LbXg-02-04

304不锈钢: 00LbXg-02-04-304

316不锈钢: 00LbXg-02-04-316

00THg 压力表接头

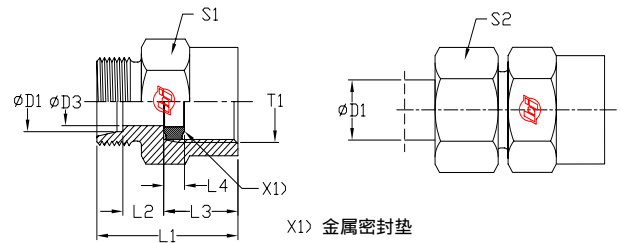

订货号	系列	钢管外径		D3	L1	L2	L3	L4	S1	S2	PN(bar)	
		D1	T1								C	SS
00THg-L06-04	L	06	G1/4	2.5	29.0	7.5	14.5	4.5	19	14	315	315
00THg-L08-04		08	G1/4	5.5	29.0	7.5	14.5	4.5	19	17	315	315
00THg-L10-04		10	G1/4	5.5	30.0	8.5	14.5	4.5	19	19	315	315
00THg-L12-04		12	G1/4	5.5	30.0	8.5	14.5	4.5	19	22	315	315
00THg-S06-08	S	06	G1/2	3.5	38.0	11.0	20.0	5.0	27	17	630	630
00THg-S08-08		08	G1/2	3.5	38.0	11.0	20.0	5.0	27	19	630	630
00THg-S10-08		10	G1/2	7.5	38.0	10.5	20.0	5.0	27	22	630	630
00THg-S12-08		12	G1/2	7.5	38.0	10.5	20.0	5.0	27	24	630	630

订货示例:

碳钢, 无六价铬镀锌: 00THg-L06-04

304不锈钢: 00THg-L06-04-304

316不锈钢: 00THg-L06-04-316

注: 订货号不含螺母卡套

注: 订货号含螺母卡套 00THg-L06-04-NBR

00SrHg 压力表组合接头

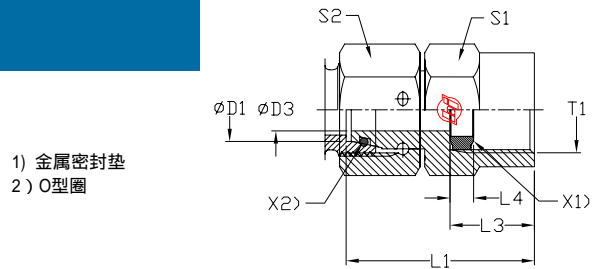

订货号	系列	钢管外径		D3	L1	L3	L4	S1	S2	PN(bar)	
		D1	T1							C	SS
00SrHg-L06-04	L	06	G1/4	2.5	35.5	14.5	4.5	19	14	315	315
00SrHg-L08-04		08	G1/4	4.0	35.5	14.5	4.5	19	17	315	315
00SrHg-L10-04		10	G1/4	5.5	36.0	14.5	4.5	19	19	315	315
00SrHg-L12-04		12	G1/4	5.5	36.0	14.5	4.5	19	22	315	315
00SrHg-S06-08	S	06	G1/2	2.5	42.5	20.0	5.0	27	17	630	630
00SrHg-S06-04		06	G1/4	2.5	35.5	14.5	4.5	19	17	630	630
00SrHg-S08-08		08	G1/2	4.0	43.0	20.0	5.0	27	19	630	630
00SrHg-S08-04		08	G1/4	4.0	35.5	14.5	4.5	19	19	630	630
00SrHg-S10-08		10	G1/2	6.0	43.5	20.0	5.0	27	22	630	630
00SrHg-S10-04		10	G1/4	7.0	39.0	14.5	4.5	19	22	630	630
00SrHg-S12-08		12	G1/2	7.0	45.0	20.0	5.0	27	24	630	630
00SrHg-S12-04		12	G1/4	7.0	39.0	14.5	4.5	19	24	630	630

订货示例:

碳钢, 无六价铬镀锌: 00SrHg-L06-04

304不锈钢: 00SrHg-L06-04-304

316不锈钢: 00SrHg-L06-04-316

PL-T 管端堵头

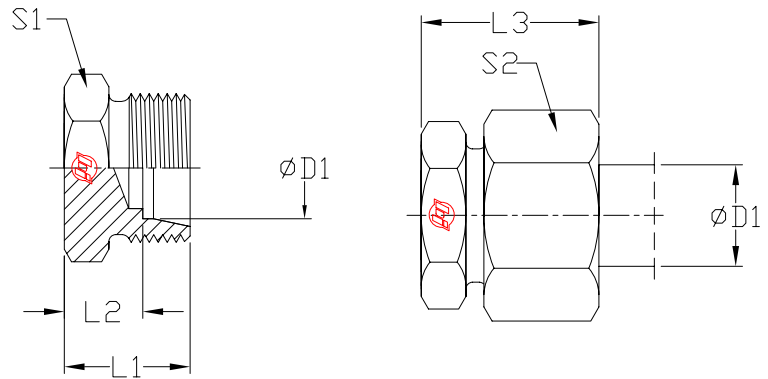

订货号	系列	钢管 外径	L1	L2	L3	S1	S2	PN(bar)	
		D1						C	SS
PL-T-L06	L	06	14.0	7.0	22.0	12	14	315	315
PL-T-L08		08	15.0	8.0	23.0	14	17	315	315
PL-T-L10		10	16.0	9.0	24.0	17	19	315	315
PL-T-L12		12	17.0	10.0	25.0	19	22	315	315
PL-T-L15		15	18.0	11.0	26.0	24	27	315	315
PL-T-L18		18	19.0	11.5	28.0	27	32	315	315
PL-T-L22		22	21.0	13.5	30.0	32	36	160	160
PL-T-L28		28	22.0	14.5	31.0	41	41	160	160
PL-T-L35		35	25.0	14.5	36.0	46	50	160	160
PL-T-L42		42	27.0	16.0	39.0	55	60	160	160
PL-T-S06	S	06	18.0	11.0	26.0	14	17	630	630
PL-T-S08		08	20.0	13.0	28.0	17	19	630	630
PL-T-S10		10	20.0	12.5	29.0	19	22	630	630
PL-T-S12		12	22.0	14.5	31.0	22	24	630	630
PL-T-S16		16	24.0	15.5	34.0	27	30	400	400
PL-T-S20		20	28.0	17.5	39.0	32	36	400	400
PL-T-S25		25	32.0	20.0	44.0	41	46	400	400
PL-T-S30		30	34.0	20.5	47.0	46	50	400	400
PL-T-S38		38	39.0	23.0	54.0	55	60	315	315

订货示例:

碳钢, 无六价铬镀锌: PL-T-L06

304不锈钢: PL-T-L06-304

316不锈钢: PL-T-L06-316

注: 订货号不含螺母卡套

注: 订货号含螺母卡套 PL-T-L06-NBR

CP-Sr 24°锥管端堵头

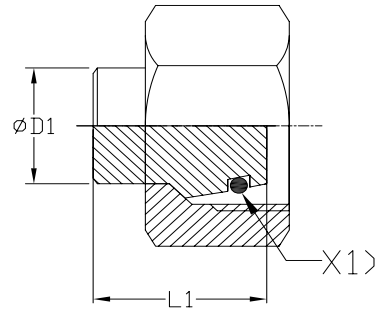

X1) O型圈

订货号	系列	钢管外径		PN(bar)	
		D1	L1	C	SS
CP-Sr-L06	L	06	18.5	500	315
CP-Sr-L08		08	18.5	500	315
CP-Sr-L10		10	20.0	500	315
CP-Sr-L12		12	20.5	400	315
CP-Sr-L15		15	20.5	400	315
CP-Sr-L18		18	22.5	400	315
CP-Sr-L22		22	25.0	250	160
CP-Sr-L28		28	25.5	250	160
CP-Sr-L35		35	30.0	250	160
CP-Sr-L42		42	30.0	250	160
CP-Sr-S06		S	06	18.5	800
CP-Sr-S08	08		18.5	800	630
CP-Sr-S10	10		20.0	800	630
CP-Sr-S12	12		20.5	630	630
CP-Sr-S16	16		23.5	630	400
CP-Sr-S20	20		28.5	420	400
CP-Sr-S25	25		29.0	420	400
CP-Sr-S30	30		30.5	420	400
CP-Sr-S38	38		33.0	420	315

订货示例:

碳钢, 无六价铬镀锌: CP-Sr-L06

304不锈钢: CP-Sr-L06-304

316不锈钢: CP-Sr-L06-316

PLH-Oe 公制油口ED堵头

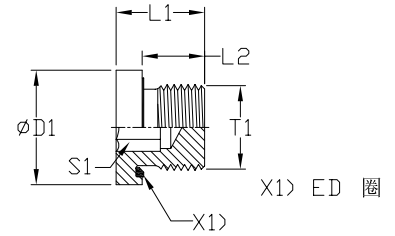

订货号	T1	D1	L1	L2	S1	PN(bar)	
						C	SS
PLH-Oe-M10*1.0	M 10x1.0	14.0	12.3	8.0	5	400	400
PLH-Oe-M12*1.5	M 12x1.5	17.0	17.3	12.0	6	400	400
PLH-Oe-M14*1.5	M 14x1.5	19.0	17.3	12.0	6	400	400
PLH-Oe-M16*1.5	M 16x1.5	22.0	17.3	12.0	8	400	400
PLH-Oe-M18*1.5	M 18x1.5	24.0	17.3	12.0	8	400	400
PLH-Oe-M20*1.5	M 20x1.5	26.0	19.3	14.0	10	400	400
PLH-Oe-M22*1.5	M 22x1.5	27.0	19.3	14.0	10	400	400
PLH-Oe-M26*1.5	M 26x1.5	32.0	21.3	16.0	12	400	400
PLH-Oe-M27*2.0	M 27x2.0	32.0	21.3	16.0	12	400	400
PLH-Oe-M33*2.0	M 33x2.0	40.0	22.8	16.0	17	400	400
PLH-Oe-M42*2.0	M 42x2.0	50.0	22.8	16.0	22	315	315
PLH-Oe-M48*2.0	M 48x2.0	55.0	22.8	16.0	24	315	315

订货示例:

碳钢, 无六价铬镀锌: PLH-Oe-M10x1.0

304不锈钢: PLH-Oe-M10x1.0-304

316不锈钢: PLH-Oe-M10x1.0-316

PLH-Og 英制油口ED堵头

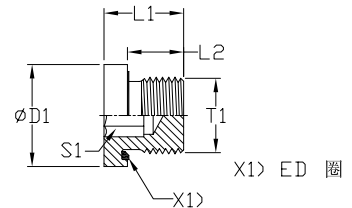

订货号	T1	D1	L1	L2	S1	PN(bar)	
						C	SS
PLH-Og-02	G1/8A	14.0	12.3	8.0	5	400	400
PLH-Og-04	G1/4A	19.0	17.3	12.0	6	400	400
PLH-Og-06	G3/8A	22.0	17.3	12.0	8	400	400
PLH-Og-08	G1/2A	27.0	19.3	14.0	10	400	400
PLH-Og-12	G3/4A	32.0	21.3	16.0	12	400	400
PLH-Og-16	G1 A	40.0	22.8	16.0	17	400	400
PLH-Og-20	G1 1/4A	50.0	22.8	16.0	22	315	315
PLH-Og-24	G1 1/2A	55.0	22.8	16.0	24	315	315
PLH-Og-32	G2A	69.9	30.0	20.0	32	315	315

订货示例:

碳钢, 无六价铬镀锌: PLH-Og-02

304不锈钢: PLH-Og-02-304

316不锈钢: PLH-Og-02-316

PLH-Om 公制油口堵头

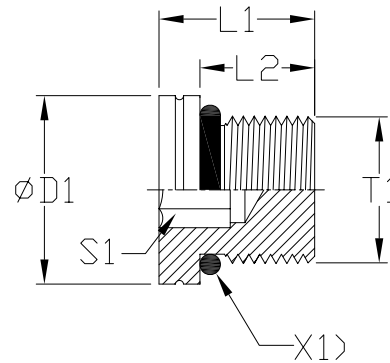

X1) O型圈

订货代号	T1	D1	L1	L2	S1	PN(bar)	
						C	SS
PLH-Om-M08*1.0	M08x1.0	12.0	13.0	9.5	4	630	630
PLH-Om-M10*1.0	M10x1.0	13.0	13.5	9.5	5	630	630
PLH-Om-M12*1.5	M12x1.5	17.0	15.0	11.0	6	630	630
PLH-Om-M14*1.5	M14x1.5	19.0	16.0	11.0	6	630	630
PLH-Om-M16*1.5	M16x1.5	21.0	17.5	12.5	8	630	630
PLH-Om-M18*1.5	M18x1.5	23.0	19.0	14.0	8	630	630
PLH-Om-M22*1.5	M22x1.5	27.0	20.0	15.0	10	630	630
PLH-Om-M26*1.5	M26x1.5	31.0	21.0	16.0	12	400	400
PLH-Om-M27*2.0	M27x2.0	32.0	23.5	18.5	12	400	400
PLH-Om-M33*2.0	M33x2.0	38.0	25.0	18.5	14	400	400
PLH-Om-M42*2.0	M42x2.0	48.0	25.5	19.0	22	400	400
PLH-Om-M48*2.0	M48x2.0	55.0	28.0	21.5	24	400	400

订货示例:

碳钢, 无六价铬镀锌: PLH-Om-M08x1.0

304不锈钢: PLH-Om-M8x1.0-304

316不锈钢: PLH-Om-M8x1.0-316

00TWb 焊接接头

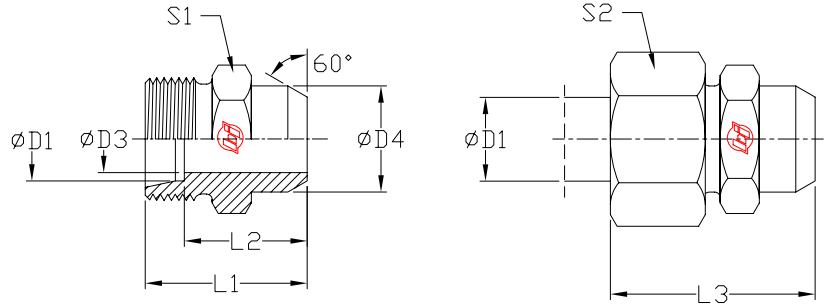

订货号	系列	钢管 外径	D3	D4	L1	L2	L3	S1	S2	PN(bar)	
		D1								C	SS
00TWb-L06-06	L	06	4.0	10.0	21.0	14.0	29.0	12	14	315	315
00TWb-L08-08		08	6.0	12.0	23.0	16.0	31.0	14	17	315	315
00TWb-L10-10		10	8.0	14.0	25.0	18.0	33.0	17	19	315	315
00TWb-L12-12		12	10.0	16.0	25.0	18.0	33.0	19	22	315	315
00TWb-L15-15		15	12.0	19.0	29.0	22.0	37.0	22	27	315	315
00TWb-L18-18		18	15.0	22.0	31.0	23.5	40.0	27	32	315	315
00TWb-L22-22		22	19.0	27.0	36.0	28.5	45.0	32	36	160	160
00TWb-L28-28		28	24.0	32.0	38.0	30.5	47.0	41	41	160	160
00TWb-L35-35		35	30.0	40.0	43.0	32.5	54.0	46	50	160	160
00TWb-L42-42		42	36.0	46.0	46.0	35.0	58.0	55	60	160	160
00TWb-S06-06	S	06	4.0	11.0	26.0	19.0	34.0	14	17	630	630
00TWb-S08-08		08	5.0	13.0	28.0	21.0	36.0	17	19	630	630
00TWb-S10-10		10	7.0	15.0	30.0	22.5	39.0	19	22	630	630
00TWb-S12-12		12	8.0	17.0	32.0	24.5	41.0	22	24	630	630
00TWb-S16-16		16	12.0	21.0	35.0	26.5	45.0	27	30	400	400
00TWb-S20-20		20	16.0	26.0	40.0	29.5	51.0	32	36	400	400
00TWb-S25-25		25	20.0	31.0	44.0	32.0	56.0	41	46	400	400
00TWb-S30-30		30	25.0	36.0	49.0	35.5	62.0	46	50	400	400
00TWb-S38-38		38	32.0	44.0	54.0	38.0	69.0	55	60	315	315

订货示例:

碳钢, 无六价铬镀锌: 00TWb-L06-06

304不锈钢: 00TWb-L06-06-304

316不锈钢: 00TWb-L06-06-316

注: 订货号不含螺母卡套

注: 订货号含螺母卡套 00TWb-L06-06-NBR

00WtWt-TSr-XX 双头活接焊接直接头

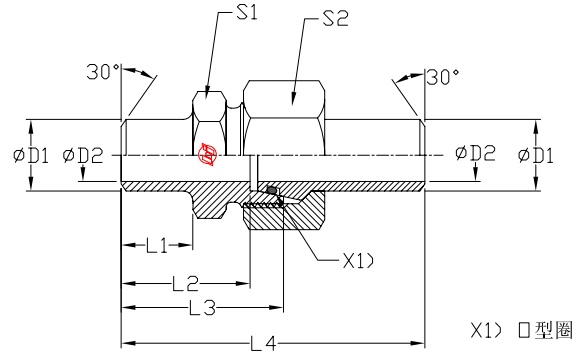

订货代号	系列	钢管 外径		L1	L2	L3	L4	S1	S2	PN(bar)	
		D1	D2							C	SS
00WtWt-TSr-10*1.0-10*1.0	S	10	8.0	10.0	24.5	32.0	58.0	19.0	22.0	250	250
00WtWt-TSr-10*1.5-10*1.5		10	7.0	10.0	24.5	32.0	58.0	19.0	22.0	350	350
00WtWt-TSr-10*2.0-10*2.0		10	6.0	10.0	24.5	32.0	58.0	19.0	22.0	460	460
00WtWt-TSr-12*1.5-12*1.5		12	9.0	15.0	29.5	37.0	63.0	22.0	24.0	310	310
00WtWt-TSr-12*2.0-12*2.0		12	8.0	15.0	29.5	37.0	63.0	22.0	24.0	400	400
00WtWt-TSr-12*2.5-12*2.5		12	7.0	15.0	29.5	37.0	63.0	22.0	24.0	480	480
00WtWt-TSr-16*1.5-16*1.5		16	13.0	16.5	33.0	41.5	73.5	27.0	30.0	240	240
00WtWt-TSr-16*2.0-16*2.0		16	12.0	16.5	33.0	41.5	73.5	27.0	30.0	310	310
00WtWt-TSr-16*2.5-16*2.5		16	11.0	16.5	33.0	41.5	73.5	27.0	30.0	380	380
00WtWt-TSr-16*3.0-16*3.0		16	10.0	16.5	33.0	41.5	73.5	27.0	30.0	400	400
00WtWt-TSr-20*2.0-20*2.0		20	16.0	19.0	36.5	47.0	83.5	32.0	36.0	250	250
00WtWt-TSr-20*2.5-20*2.5		20	15.0	19.0	36.5	47.0	83.5	32.0	36.0	310	310
00WtWt-TSr-20*3.0-20*3.0		20	14.0	19.0	36.5	47.0	83.5	32.0	36.0	360	360
00WtWt-TSr-20*4.0-20*4.0		20	12.0	19.0	36.5	47.0	83.5	32.0	36.0	400	400
00WtWt-TSr-25*3.0-25*3.0		25	19.0	19.5	39.5	51.5	92.5	41.0	46.0	300	300
00WtWt-TSr-25*4.0-25*4.0		25	17.0	19.5	39.5	51.5	92.5	41.0	46.0	380	380
00WtWt-TSr-25*5.0-25*5.0		25	15.0	19.5	39.5	51.5	92.5	41.0	46.0	400	400
00WtWt-TSr-30*3.0-30*3.0		30	24.0	23.0	44.5	58.0	101.5	46.0	50.0	250	250
00WtWt-TSr-30*4.0-30*4.0		30	22.0	23.0	44.5	58.0	101.5	46.0	50.0	320	320
00WtWt-TSr-30*5.0-30*5.0		30	20.0	23.0	44.5	58.0	101.5	46.0	50.0	400	400
00WtWt-TSr-30*6.0-30*6.0		30	18.0	23.0	44.5	58.0	101.5	46.0	50.0	400	400
00WtWt-TSr-38*4.0-38*4.0		38	30.0	22.0	44.0	60.0	108.0	55.0	60.0	260	260
00WtWt-TSr-38*5.0-38*5.0		38	28.0	22.0	44.0	60.0	108.0	55.0	60.0	315	315
00WtWt-TSr-38*6.0-38*6.0		38	26.0	22.0	44.0	60.0	108.0	55.0	60.0	315	315
00WtWt-TSr-38*7.0-38*7.0		38	24.0	22.0	44.0	60.0	108.0	55.0	60.0	315	315

订货示例:

碳钢, 煮黑处理: 00WtWt-TSr-10*1.0-10*1.0

304不锈钢: 00WtWt-TSr-10*1.0-10*1.0-304

316不锈钢: 00WtWt-TSr-10*1.0-10*1.0-316

00SrWt 焊接直接头

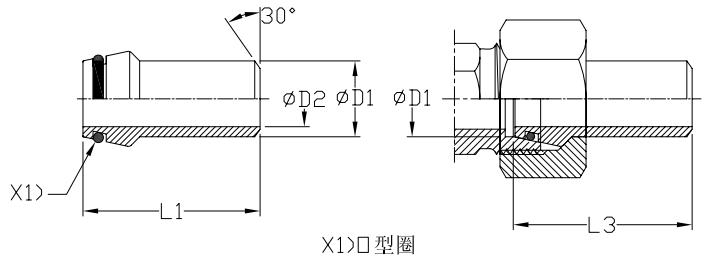

订货号	系列	钢管 外径					PN(bar)	
		D1	D2	L1	L3	适用钢管	C	SS
00SrWt-L06-06*1.5-IN	L/S	06	3.0	31.0	31.5	06x1.5	540	540
00SrWt-L08-08*1.5-IN		08	4.5	31.0	31.5	08x1.5	430	430
00SrWt-L08-08*2.0-IN		08	4.0	31.0	31.5	08x2.0	540	540
00SrWt-L10-10*1.0-IN		10	8.0	32.5	33.5	10x1.0	250	250
00SrWt-L10-10*1.5-IN		10	7.0	32.5	33.5	10x1.5	360	360
00SrWt-L10-10*2.0-IN		10	6.0	32.5	33.5	10x2.0	460	460
00SrWt-L12-12*1.5-IN		12	9.0	32.5	33.5	12x1.5	310	310
00SrWt-L12-12*2.0-IN		12	8.0	32.5	33.5	12x2.0	400	400
00SrWt-L12-12*2.5-IN		12	7.0	32.5	33.5	12x2.5	480	480
00SrWt-L15-15*2.0-IN	L	15	11.0	34.0	34.5	15x2.0	315	315
00SrWt-L15-15*2.5-IN		15	10.0	34.0	34.5	15x2.5	315	315
00SrWt-L18-18*2.5-IN		18	13.0	35.5	36.5	18x2.5	315	315
00SrWt-L22-22*2.5-IN		22	17.0	38.5	39.5	22x2.5	160	160
00SrWt-L28-28*2.5-IN		28	23.0	41.5	42.5	28x2.5	160	160
00SrWt-L28-28*3.0-IN		28	22.0	41.5	42.5	28x3.0	160	160
00SrWt-L35-35*3.5-IN		35	28.0	47.5	49.5	35x3.5	160	160
00SrWt-L35-35*4.0-IN		35	27.0	47.5	49.5	35x4.0	160	160
00SrWt-L42-42*3.0-IN		42	36.0	47.5	50.0	42x3.0	160	160
00SrWt-L42-42*4.0-IN	42	34.0	47.5	50.0	42x4.0	160	160	
00SrWt-S16-16*1.5-IN	S	16	13.0	39.0	40.5	16x1.5	240	240
00SrWt-S16-16*2.0-IN		16	12.0	39.0	40.5	16x2.0	310	310
00SrWt-S16-16*2.5-IN		16	11.0	39.0	40.5	16x2.5	380	380
00SrWt-S16-16*3.0-IN		16	10.0	39.0	40.5	16x3.0	400	400
00SrWt-S20-20*2.0-IN		20	16.0	45.0	47.0	20x2.0	250	250
00SrWt-S20-20*2.5-IN		20	15.0	45.0	47.0	20x2.5	310	310
00SrWt-S20-20*3.0-IN		20	14.0	45.0	47.0	20x3.0	360	360
00SrWt-S20-20*3.5-IN		20	13.0	45.0	47.0	20x3.5	400	400
00SrWt-S20-20*4.0-IN		20	12.0	45.0	47.0	20x4.0	400	400
00SrWt-S25-25*3.0-IN		25	19.0	49.5	53.0	25x3.0	300	300
00SrWt-S25-25*3.5-IN		25	18.0	49.5	53.0	25x3.5	340	340
00SrWt-S25-25*4.0-IN		25	17.0	49.5	53.0	25x4.0	380	380
00SrWt-S25-25*5.0-IN		25	15.0	49.5	53.0	25x5.0	400	400
00SrWt-S30-30*3.0-IN		30	24.0	52.0	57.0	30x3.0	250	250
00SrWt-S30-30*4.0-IN		30	22.0	52.0	57.0	30x4.0	320	320
00SrWt-S30-30*5.0-IN		30	20.0	52.0	57.0	30x5.0	400	400
00SrWt-S30-30*6.0-IN		30	18.0	52.0	57.0	30x6.0	400	400
00SrWt-S38-38*3.0-IN		38	32.0	56.5	64.0	38x3.0	200	200
00SrWt-S38-38*4.0-IN		38	30.0	56.5	64.0	38x4.0	260	260
00SrWt-S38-38*5.0-IN		38	28.0	56.5	64.0	38x5.0	315	315
00SrWt-S38-38*6.0-IN		38	26.0	56.5	64.0	38x6.0	315	315
00SrWt-S38-38*7.0-IN		38	24.0	56.5	64.0	38x7.0	315	315

订货示例:

(1) 注: 订货号不含螺母

碳钢, 煮黑处理: 00SrWt-L06-06*1.5-IN

304不锈钢: 00SrWt-L06-06*1.5-IN-304

316不锈钢: 00SrWt-L06-06*1.5-IN-316

(2) 注: 订货号含螺母

碳钢, 煮黑处理: 00SrWt-L06-06*1.5

304不锈钢: 00SrWt-L06-06*1.5-304

316不锈钢: 00SrWt-L06-06*1.5-316

00SrWt 变径焊接直接头

图A

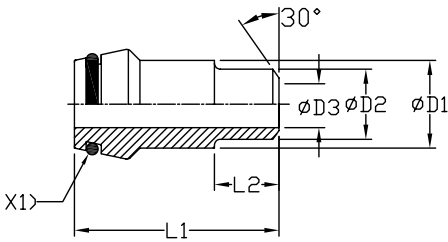

图B

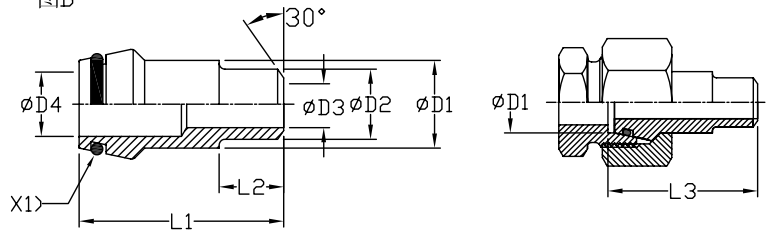

X1) O型圈

订货代号	系列	钢管外径							图号	PN(bar)	
		D1	D2	D3	D4	L1	L2	L3		C	SS
00SrWt-L08-06*1.5-IN	L/S	08	6.0	3.0	—	31.0	12.0	31.5	A	540	540
00SrWt-L10-06*1.5-IN		10	6.0	3.0	5.0	32.5	12.0	33.5	B	540	540
00SrWt-L10-08*1.5-IN		10	8.0	5.0	—	32.5	12.0	33.5	A	430	430
00SrWt-L10-08*2.0-IN		10	8.0	4.0	—	32.5	12.0	33.5	A	540	540
00SrWt-L12-08*1.5-IN		12	8.0	5.0	—	32.5	14.0	33.5	A	430	430
00SrWt-L12-08*2.0-IN		12	8.0	4.0	6.0	32.5	14.0	33.5	B	540	540
00SrWt-L12-10*1.5-IN		12	10.0	7.0	—	32.5	14.0	33.5	A	360	360
00SrWt-S16-10*2.0-IN	S	16	10.0	6.0	—	39.0	15.0	40.5	A	400	400
00SrWt-S16-12*1.5-IN		16	12.0	9.0	—	39.0	15.0	40.5	A	310	310
00SrWt-S16-12*2.0-IN		16	12.0	8.0	—	39.0	15.0	40.5	A	400	400
00SrWt-S16-12*2.5-IN		16	12.0	7.0	—	39.0	15.0	40.5	A	400	400
00SrWt-S20-12*1.5-IN		20	12.0	9.0	—	45.0	17.0	47.0	A	310	310
00SrWt-S20-12*2.0-IN		20	12.0	8.0	—	45.0	17.0	47.0	A	400	400
00SrWt-S20-12*2.5-IN		20	12.0	7.0	—	45.0	17.0	47.0	A	400	400
00SrWt-S20-12*3.0-IN		20	12.0	6.0	—	45.0	17.0	47.0	A	400	400
00SrWt-S20-16*2.0-IN		20	16.0	12.0	—	45.0	17.0	47.0	A	310	310
00SrWt-S20-16*2.5-IN		20	16.0	11.0	—	45.0	17.0	47.0	A	380	380
00SrWt-S20-16*3.0-IN		20	16.0	10.0	—	45.0	17.0	47.0	A	400	400
00SrWt-S25-12*1.5-IN		25	12.0	9.0	—	49.5	20.0	53.0	A	310	310
00SrWt-S25-12*2.0-IN		25	12.0	8.0	—	49.5	20.0	53.0	A	400	400
00SrWt-S25-12*2.5-IN		25	12.0	7.0	—	49.5	20.0	53.0	A	400	400
00SrWt-S25-12*3.0-IN		25	12.0	6.0	15.0	49.5	20.0	53.0	B	400	400
00SrWt-S25-16*2.0-IN		25	16.0	12.0	—	49.5	20.0	53.0	A	310	310
00SrWt-S25-16*2.5-IN		25	16.0	11.0	—	49.5	20.0	53.0	A	380	380
00SrWt-S25-16*3.0-IN		25	16.0	10.0	—	49.5	20.0	53.0	A	400	400
00SrWt-S25-20*2.0-IN		25	20.0	16.0	—	49.5	20.0	53.0	A	250	250
00SrWt-S25-20*2.5-IN		25	20.0	15.0	—	49.5	20.0	53.0	A	310	310

00SrWt 变径焊接直接头

图A

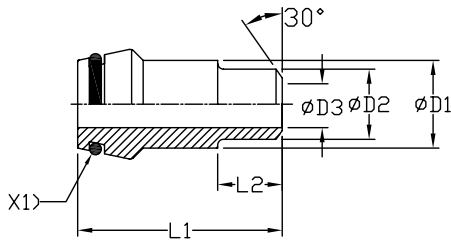

图B

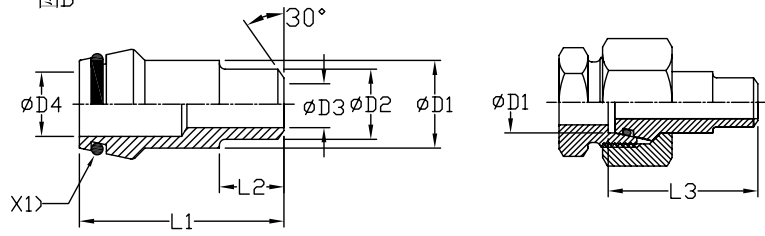

续上表

X1) □型圈

订货代号	系列	钢管外径			D4	L1	L2	L3	图号	PN(bar)	
		D1	D2	D3						C	SS
00SrWt-S25-20*3.0-IN	S	25	20.0	14.0	—	49.5	20.0	53.0	A	360	360
00SrWt-S25-20*4.0-IN		25	20.0	12.0	—	49.5	20.0	53.0	A	400	400
00SrWt-S30-12*1.5-IN		30	12.0	9.0	22.0	52.0	22.0	57.0	B	310	310
00SrWt-S30-12*2.0-IN		30	12.0	8.0	22.0	52.0	22.0	57.0	B	380	380
00SrWt-S30-12*3.0-IN		30	12.0	6.0	22.0	52.0	22.0	57.0	B	400	400
00SrWt-S30-16*2.0-IN		30	16.0	12.0	—	52.0	22.0	57.0	A	310	310
00SrWt-S30-16*2.5-IN		30	16.0	11.0	—	52.0	22.0	57.0	A	360	360
00SrWt-S30-20*2.0-IN		30	20.0	16.0	—	52.0	22.0	57.0	A	250	250
00SrWt-S30-20*2.5-IN		30	20.0	15.0	—	52.0	22.0	57.0	A	300	300
00SrWt-S30-20*3.0-IN		30	20.0	14.0	—	52.0	22.0	57.0	A	360	360
00SrWt-S30-20*4.0-IN		30	20.0	12.0	—	52.0	22.0	57.0	A	400	400
00SrWt-S30-25*2.5-IN		30	25.0	20.0	—	52.0	22.0	57.0	A	250	250
00SrWt-S30-25*3.0-IN		30	25.0	19.0	—	52.0	22.0	57.0	A	300	300
00SrWt-S30-25*4.0-IN		30	25.0	17.0	—	52.0	22.0	57.0	A	380	380
00SrWt-S38-12*1.5-IN		38	12.0	9.0	28.0	56.5	26.0	64.0	B	315	315
00SrWt-S38-12*2.0-IN		38	12.0	8.0	28.0	56.5	26.0	64.0	B	315	315
00SrWt-S38-12*3.0-IN		38	12.0	6.0	28.0	56.5	26.0	64.0	B	315	315
00SrWt-S38-16*2.0-IN		38	16.0	12.0	—	56.5	26.0	64.0	A	315	315
00SrWt-S38-16*2.5-IN		38	16.0	11.0	—	56.5	26.0	64.0	A	315	315
00SrWt-S38-16*3.0-IN		38	16.0	10.0	—	56.5	26.0	64.0	A	315	315
00SrWt-S38-20*2.0-IN		38	20.0	16.0	—	56.5	26.0	64.0	A	250	250
00SrWt-S38-20*2.5-IN		38	20.0	15.0	—	56.5	26.0	64.0	A	315	315
00SrWt-S38-20*3.0-IN		38	20.0	14.0	—	56.5	26.0	64.0	A	315	315
00SrWt-S38-20*4.0-IN		38	20.0	12.0	—	56.5	26.0	64.0	A	315	315
00SrWt-S38-25*2.5-IN		38	25.0	20.0	—	56.5	26.0	64.0	A	250	250
00SrWt-S38-25*3.0-IN		38	25.0	19.0	—	56.5	26.0	64.0	A	315	315
00SrWt-S38-25*4.0-IN		38	25.0	17.0	—	56.5	26.0	64.0	B	315	315
00SrWt-S38-30*3.0-IN		38	30.0	24.0	—	56.5	26.0	64.0	A	250	250
00SrWt-S38-30*4.0-IN		38	30.0	22.0	—	56.5	26.0	64.0	A	315	315
00SrWt-S38-30*5.0-IN		38	30.0	20.0	—	56.5	26.0	64.0	A	315	315

订货示例:

(1) 注: 订货号不含螺母

碳钢, 煮黑处理: 00SrWt-L08-06*1.5-IN

304不锈钢: 00SrWt-L08-06*1.5-IN-304

316不锈钢: 00SrWt-L08-06*1.5-IN-316

(2) 注: 订货号含螺母

碳钢, 煮黑处理: 00SrWt-L08-06*1.5

304不锈钢: 00SrWt-L08-06*1.5-304

316不锈钢: 00SrWt-L08-06*1.5-316

90TWb 90°焊接接头

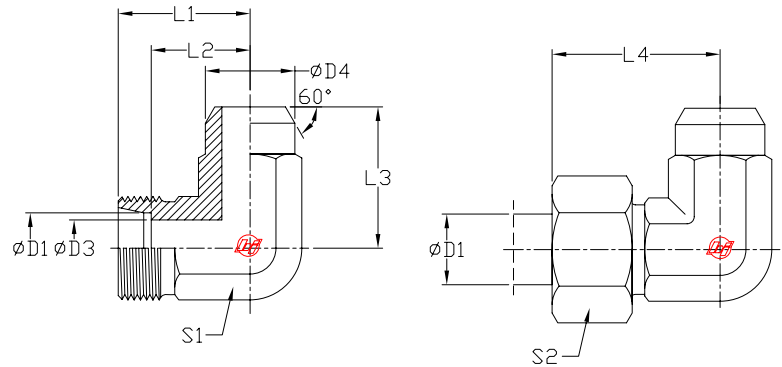

订货号	系列	钢管外径		D4	L1	L2	L3	L4	S1	S2	PN(bar)	
		D1	D3								C	SS
90TWb-L06-06	L	06	4.0	10.0	19.0	12.0	19.0	27.0	12	14	315	315
90TWb-L08-08		08	6.0	12.0	21.0	14.0	23.0	29.0	12	17	315	315
90TWb-L10-10		10	8.0	14.0	22.0	15.0	24.0	30.0	14	19	315	315
90TWb-L12-12		12	10.0	16.0	24.0	17.0	25.0	32.0	17	22	315	315
90TWb-L15-15		15	12.0	19.0	28.0	21.0	30.0	36.0	19	27	315	315
90TWb-L18-18		18	15.0	22.0	31.0	23.5	33.0	40.0	24	32	315	315
90TWb-L22-22		22	19.0	27.0	35.0	27.5	37.0	44.0	27	36	160	160
90TWb-L28-28		28	24.0	32.0	38.0	30.5	42.0	47.0	36	41	160	160
90TWb-L35-35		35	30.0	40.0	45.0	34.5	49.0	56.0	41	50	160	160
90TWb-L42-42		42	36.0	46.0	51.0	40.0	57.0	63.0	50	60	160	160
90TWb-S06-06	S	06	4.0	11.0	23.0	16.0	23.0	31.0	12	17	630	630
90TWb-S08-08		08	5.0	13.0	24.0	17.0	24.0	32.0	14	19	630	630
90TWb-S10-10		10	7.0	15.0	25.0	17.5	25.0	34.0	17	22	630	630
90TWb-S12-12		12	8.0	17.0	29.0	21.5	29.0	38.0	17	24	630	630
90TWb-S14-14		14	10.0	19.0	30.0	22.0	30.0	40.0	19	27	630	630
90TWb-S16-16		16	12.0	21.0	33.0	24.5	33.0	43.0	24	30	400	400
90TWb-S20-20		20	16.0	26.0	37.0	26.5	37.0	48.0	27	36	400	400
90TWb-S25-25		25	20.0	31.0	42.0	30.0	42.0	54.0	36	46	400	400
90TWb-S30-30		30	25.0	36.0	49.0	35.5	49.0	62.0	41	50	400	400
90TWb-S38-38		38	32.0	44.0	57.0	41.0	57.0	72.0	50	60	315	315

订货示例:

碳钢, 无六价铬镀锌: 90TWb-L06-06

304不锈钢: 90TWb-L06-06-304

316不锈钢: 90TWb-L06-06-316

注: 订货号不含螺母卡套

注: 订货号含螺母卡套 90TWb-L06-06-NBR

00TT-W 直通过板焊接接头

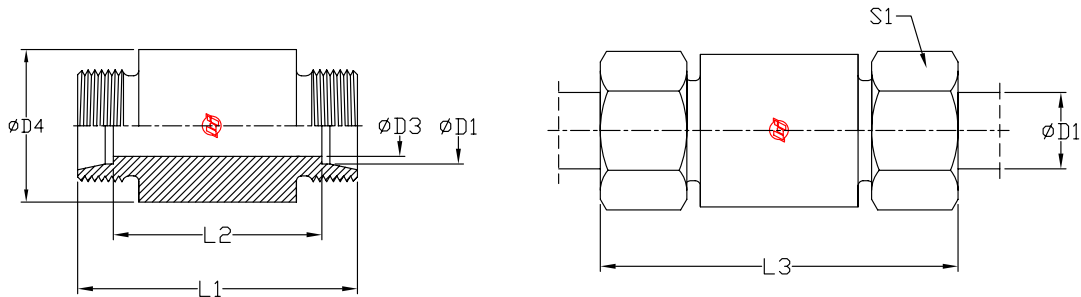

订货代号	系列	钢管外径							PN(bar)	
		D1	D3	D4	L1	L2	L3	S1	C	SS
00TT-W-L06-L06	L	06	4.0	18.0	70.0	56.0	85.0	14	500	315
00TT-W-L08-L08		08	6.0	20.0	70.0	56.0	85.0	17	500	315
00TT-W-L10-L10		10	8.0	22.0	72.0	58.0	87.0	19	500	315
00TT-W-L12-L12		12	10.0	25.0	72.0	58.0	87.0	22	400	315
00TT-W-L15-L15		15	12.0	28.0	84.0	70.0	100.0	27	400	315
00TT-W-L18-L18		18	15.0	32.0	84.0	69.0	101.0	32	400	315
00TT-W-L22-L22		22	19.0	36.0	88.0	73.0	105.0	36	250	160
00TT-W-L28-L28		28	24.0	40.0	88.0	73.0	106.0	41	250	160
00TT-W-L35-L35		35	30.0	50.0	92.0	71.0	114.0	50	250	160
00TT-W-L42-L42		42	36.0	60.0	92.0	70.0	115.0	60	250	160
00TT-W-S06-S06	S	06	4.0	20.0	74.0	60.0	89.0	17	800	630
00TT-W-S08-S08		08	5.0	22.0	74.0	60.0	89.0	19	800	630
00TT-W-S10-S10		10	7.0	25.0	74.0	59.0	91.0	22	800	630
00TT-W-S12-S12		12	8.0	28.0	74.0	59.0	91.0	24	630	630
00TT-W-S14-S14		14	10.0	30.0	88.0	72.0	107.0	27	630	630
00TT-W-S16-S16		16	12.0	35.0	88.0	71.0	107.0	30	630	400
00TT-W-S20-S20		20	16.0	38.0	92.0	71.0	114.0	36	420	400
00TT-W-S25-S25		25	20.0	45.0	96.0	72.0	120.0	46	420	400
00TT-W-S30-S30		30	25.0	50.0	100.0	73.0	126.0	50	420	400
00TT-W-S38-S38		38	32.0	60.0	104.0	72.0	133.0	60	420	315

订货示例:

碳钢, 无六价铬镀锌: 00TT-W-L06-L06

304不锈钢: 00TT-W-L06-L06-304

316不锈钢: 00TT-W-L06-L06-316

注: 订货号不含螺母卡套

注: 订货号含螺母卡套 00TT-W-L06-L06-NBR

1951/1952 对开法兰片

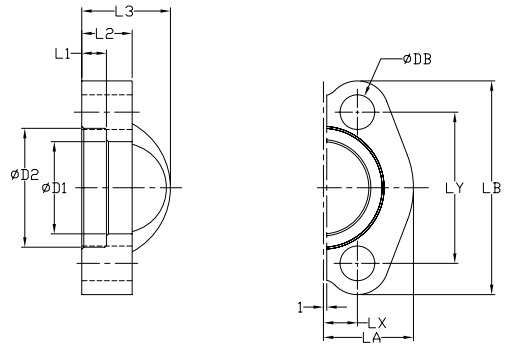

3000PSI系列

订货号	法兰尺寸		D1	D2	L1	L2	L3	LA	LB	LX	LY	DB	螺栓		PN(bar)	
	SAE (in.)	ISO (DN)											公制螺栓	美制螺栓	C	SS
1951-08	1/2	13	24.3	31.0	6.2	13.0	19.0	23.0	54.0	8.7	38.1	9.0	M08x25	5/16x1 1/4	345	345
1951-12	3/4	19	32.2	38.9	6.2	14.0	22.0	25.9	65.0	11.1	47.6	11.0	M10x30	3/8x1 1/4	345	345
1951-16	1	25	38.5	45.2	7.5	16.0	24.0	29.2	69.9	13.1	52.4	11.0	M10x30	3/8x1 1/4	345	345
1951-20-M10	1 1/4	32	43.7	51.6	7.5	16.0	22.0	36.3	79.4	15.1	58.7	11.0	M10x35	—	276	276
1951-20-M12	1 1/4	32	43.7	51.6	7.5	16.0	22.0	36.3	79.4	15.1	58.7	12.0	—	7/16x1 1/2	276	276
1951-20	1 1/4	32	43.7	51.6	7.5	16.0	22.0	36.3	79.4	15.1	58.7	12.5	M12x35	—	276	276
1951-24	1 1/2	38	50.8	61.1	7.5	16.0	25.0	41.1	93.8	17.9	69.9	13.0	M12x35	1/2x1 1/2	207	207
1951-24-M14	1 1/2	38	50.8	61.1	7.5	16.0	25.0	41.1	93.8	17.9	69.9	14.5	M14x35	—	207	207
1951-32-M12	2	51	62.8	72.3	9.0	16.0	26.0	48.2	101.6	21.4	77.8	13.0	M12x35	1/2x1 1/2	207	207
1951-32	2	51	62.8	72.3	9.0	16.0	26.0	48.2	101.6	21.4	77.8	14.5	M14x35	—	207	207
1951-40	2 1/2	64	74.9	84.9	9.0	19.0	38.0	54.1	114.3	25.4	88.9	13.0	M12x40	1/2x1 3/4	172	172
1951-40-M14	2 1/2	64	74.9	84.9	9.0	19.0	38.0	54.1	114.3	25.4	88.9	14.5	M14x40	—	172	172
1951-48	3	76	90.9	102.4	9.0	22.0	41.0	65.3	135.0	31.0	106.4	17.0	M16x45	5/8x1 3/4	138	138
1951-56	3 1/2	89	102.4	115.0	10.7	22.0	28.0	68.6	152.4	34.9	120.7	17.0	M16x45	5/8x2	34	34
1951-64	4	102	115.1	127.8	10.7	25.0	35.0	74.9	162.0	38.9	130.2	17.0	M16x50	5/8x2	34	34
1951-80	5	127	140.5	153.2	10.7	28.0	41.0	89.4	184.2	46.0	152.4	17.0	M16x50	5/8x2 1/4	34	34

6000PSI系列

订货号	法兰尺寸		D1	D2	L1	L2	L3	LA	LB	LX	LY	DB	螺栓		PN(bar)	
	SAE (in.)	ISO (DN)											公制螺栓	美制螺栓	C	SS
1952-08	1/2	13	24.6	32.5	7.2	16.0	22.0	24.0	56.4	9.1	40.5	9.0	M 08x30	5/16x1 1/4	420	420
1952-12	3/4	19	32.5	42.0	8.3	19.0	28.0	30.0	72.0	11.9	50.8	11.0	M10x35	3/8x1 1/2	420	420
1952-16	1	25	38.8	48.4	9.0	24.0	33.0	34.8	81.0	13.9	57.2	13.0	M12x45	—	420	420
1952-16-M12	1	25	38.9	48.4	9.0	24.0	33.0	34.8	81.0	13.9	57.2	12.0	—	7/16x1 3/4	420	420
1952-20	1 1/4	32	44.5	54.8	9.8	27.0	38.0	38.6	95.3	15.9	66.6	15.0	M14x50	—	420	420
1952-20-M12	1 1/4	32	44.5	54.8	9.8	27.0	38.0	38.6	95.3	15.9	66.6	13.0	M12x45	1/2x1 3/4	420	420
1952-24	1 1/2	38	51.6	64.3	12.1	30.0	43.0	47.5	112.8	18.3	79.3	17.0	M16x55	5/8x2 1/4	420	420
1952-32	2	51	67.6	80.2	12.1	37.0	52.0	56.9	133.4	22.2	96.8	22.0	M 20x65	3/4x2 3/4	420	420
1952-40	2 1/2	64	90.0	108.0	20.0	45.0	45.0	75.1	180.0	29.4	123.8	25.0	M24x75	—	420	420
1952-48	3	76	115.0	132.5	25.0	55.0	55.0	99.1	215.0	35.7	152.4	31.5	M 30x90	—	420	420

订货示例：
 碳钢, 无六价铬镀锌: 1951-08
 304不锈钢: 1951-08-304
 316不锈钢: 1951-08-316

00TCj 法兰直接头

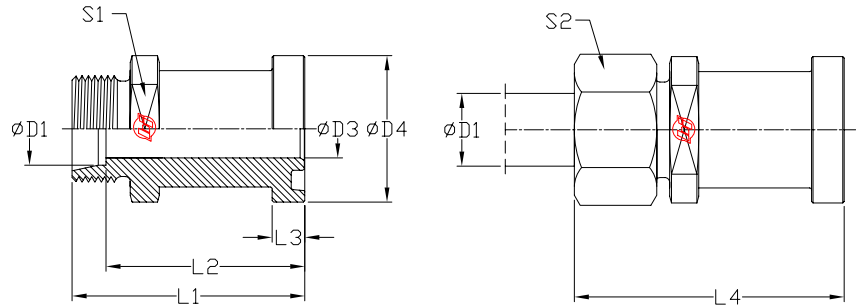

3000PSI系列

订货号	法兰尺寸 SAE ISO		钢管 D1	D3	D4	L1	L2	L3	L4	S1	S2	螺栓		PN(bar)	
	(in.)	(DN)										公制螺栓	美制螺栓	C	SS
00TCj-L15-08	1/2	13	15L	12.0	30.2	48.0	41.0	6.7	56.0	24	27	M 08x25	5/16x1 1/4	315	315
00TCj-S16-08	1/2	13	16S	12.0	30.2	50.0	41.5	6.7	60.0	24	30	M 08x25	5/16x1 1/4	350	350
00TCj-L18-08	1/2	13	18L	14.0	30.2	50.0	42.5	6.7	61.0	19	32	M 08x25	5/16x1 1/4	315	315
00TCi-S16-12	3/4	19	16S	12.0	38.1	55.0	46.5	6.7	64.5	27	30	M 10x30	3/8x1 1/4	350	350
00TCj-L18-12	3/4	19	18L	17.0	38.1	53.0	45.5	6.7	62.0	30	32	M 10x30	3/8x1 1/4	315	315
00TCj-L22-12	3/4	19	22L	19.0	38.1	53.0	45.5	6.7	62.0	30	36	M10x30	3/8x1 1/4	160	160
00TCj-L28-12	3/4	19	28L	19.0	38.1	55.0	41.0	6.7	64.0	32	41	M10x30	3/8x1 1/4	160	160
00TCj-S20-12	3/4	19	20S	17.0	38.1	57.0	46.5	6.7	68.0	30	36	M 10x30	3/8x1 1/4	350	350
00TCj-S25-12	3/4	19	25S	17.0	38.1	57.0	45.0	6.7	69.0	30	46	M 10x30	3/8x1 1/4	350	350
00TCj-S20-16	1	25	20S	25.0	44.5	60.0	48.5	8.0	71.0	32	36	M 10x30	3/8x1 1/4	350	350
00TCj-L28-16	1	25	28L	24.0	44.5	54.0	46.5	8.0	63.0	36	41	M10x30	3/8x1 1/4	160	160
00TCj-S25-16	1	25	25S	20.0	44.5	58.0	46.5	8.0	60.0	36	46	M 10x30	3/8x1 1/4	350	350
00TCj-S30-16	1	25	30S	24.0	44.5	63.0	49.5	8.0	76.0	36	50	M 10x30	3/8x1 1/4	250	250
00TCj-L42-16	1	25	42L	24.0	44.5	76.0	65.0	8.0	87.5	41	60	M10x30	3/8x1 1/4	160	160
00TCj-L35-20-F	1 1/4	32	35L	32.0	50.8	58.0	47.5	8.0	69.0	41	50	M10x35	—	160	160
00TCj-S25-20-F	1 1/4	32	25S	27.0	50.8	60.0	48.0	8.0	72.0	41	46	M10x35	—	200	200
00TCj-S30-20-F	1 1/4	32	30S	28.5	50.8	62.0	48.5	8.0	75.0	41	50	M10x35	—	200	200
00TCj-S38-20-F	1 1/4	32	38S	28.0	50.8	66.0	50.0	8.0	81.0	46	60	M10x35	—	200	200
00TCj-L28-20	1 1/4	32	28L	23.0	50.8	60.0	52.5	8.0	67.0	36	41	M12x40	7/16x1 1/2	160	160
00TCj-L35-20	1 1/4	32	35L	32.0	50.8	58.0	47.5	8.0	69.0	41	50	M12x40	7/16x1 1/2	160	160
00TCj-S25-20	1 1/4	32	25S	27.0	50.8	60.0	48.0	8.0	72.0	41	46	M12x40	7/16x1 1/2	200	200
00TCj-S30-20	1 1/4	32	30S	28.5	50.8	62.0	48.5	8.0	75.0	41	50	M12x40	7/16x1 1/2	200	200
00TCj-S38-20	1 1/4	32	38S	28.0	50.8	66.0	50.0	8.0	81.0	46	60	M12x40	7/16x1 1/2	200	200
00TCj-L35-24	1 1/2	38	35L	30.0	60.3	65.0	54.5	8.0	76.0	46	50	M12x35	1/2x1 1/2	160	160
00TCj-L42-24	1 1/2	38	42L	36.0	60.3	64.0	53.0	8.0	76.0	46	60	M12x35	1/2x1 1/2	160	160
00TCj-S38-24	1 1/2	38	38S	32.0	60.3	70.0	54.0	8.0	85.0	46	60	M12x35	1/2x1 1/2	200	200

订货示例:

碳钢, 无六价铬镀锌: 00TCj-L15-08

304不锈钢: 00TCj-L15-08-304

316不锈钢: 00TCj-L15-08-316

注: 订货号不含螺母卡套

注: 订货号含螺母卡套 00TCj-L15-08-NBR

00TCd 法兰直接头

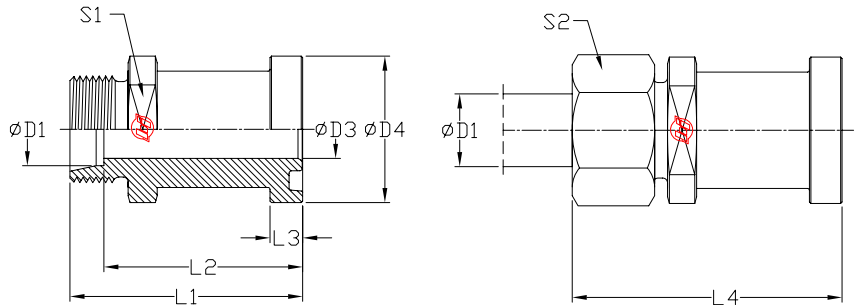

6000PSI系列

订货号	法兰尺寸 SAE ISO		D1	D3	D4	L1	L2	L3	L4	S1	S2	螺栓		PN(bar)	
	(in.)	(DN)										公制螺栓	美制螺栓	C	SS
00TCd-S12-08	1/2	13	12S	8.0	31.8	50.0	42.5	7.7	57.5	19	24	M 08x30	5/16x1 1/4	420	420
00TCd-S14-08	1/2	13	14S	10.0	31.8	50.0	42.0	7.7	59.5	19	27	M 08x30	5/16x1 1/4	420	420
00TCd-S16-08	1/2	13	16S	12.0	31.8	53.0	44.5	7.7	62.5	24	30	M 08x30	5/16x1 1/4	420	420
00TCd-S16-12	3/4	19	16S	17.0	41.3	59.0	50.5	8.7	68.5	30	30	M10x35	3/8x1 1/2	420	420
00TCd-S20-12	3/4	19	20S	17.0	41.3	61.0	50.5	8.7	72.0	30	36	M10x35	3/8x1 1/2	420	400
00TCd-S25-12	3/4	19	25S	17.0	41.3	63.0	51.0	8.7	75.0	30	46	M10x35	3/8x1 1/2	420	400
00TCd-S30-12	3/4	19	30S	18.0	41.3	76.0	62.0	8.7	89.0	30	50	M10x35	3/8x1 1/2	420	400
00TCd-S38-12	3/4	19	38S	18.0	41.3	85.0	69.0	8.7	99.5	41	60	M10x35	3/8x1 1/2	315	315
00TCd-S20-16	1	25	20S	16.0	47.6	75.0	64.5	9.5	88.0	36	36	M12x45	7/16x1 3/4	420	400
00TCd-S25-16	1	25	25S	20.0	47.6	72.0	60.0	9.5	84.0	36	46	M12x45	7/16x1 3/4	420	400
00TCd-S30-16	1	25	30S	24.0	47.6	74.0	62.0	9.5	87.0	36	50	M12x45	7/16x1 3/4	420	400
00TCd-S38-16	1	25	38S	24.0	47.6	84.5	68.0	9.5	99.0	46	60	M12x45	7/16x1 3/4	315	315
00TCd-S25-20	1 1/4	32	25S	20.0	54.0	80.0	68.0	10.2	92.0	41	46	M14x50	1/2x1 3/4	420	400
00TCd-S30-20-F	1 1/4	32	30S	30.0	54.0	79.0	65.5	10.2	92.0	41	50	M12x45	—	420	400
00TCd-S38-20-F	1 1/4	32	38S	30.0	54.0	83.0	67.0	10.2	97.5	46	60	M12x45	—	315	315
00TCd-S30-20	1 1/4	32	30S	30.0	54.0	79.0	65.5	10.2	92.0	41	50	M14x50	1/2x1 3/4	420	400
00TCd-S38-20	1 1/4	32	38S	30.0	54.0	83.0	67.0	10.2	97.5	46	60	M14x50	1/2x1 3/4	315	315
00TCd-S30-24	1 1/2	38	30S	30.0	63.5	90.0	74.0	12.5	103.0	46	50	M16x55	5/8x2 1/4	420	400
00TCd-S38-24	1 1/2	38	38S	30.0	63.5	89.0	73.0	12.5	103.5	46	60	M16x55	5/8x2 1/4	315	315

订货示例:

碳钢, 无六价铬镀锌: 00TCd-S12-08

304不锈钢: 00TCd-S12-08-304

316不锈钢: 00TCd-S12-08-316

注: 订货号不含螺母卡套

注: 订货号含螺母卡套 00TCd-S12-08-NBR

90TCj 法兰90°弯头

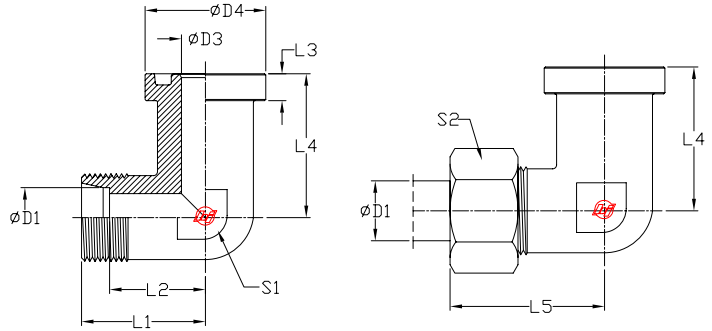

3000PSI系列

订货号	法兰尺寸 SAE ISO		D1	D3	D4	L1	L2	L3	L4	L5	S1	S2	螺栓		PN(bar)	
	(in.)	(DN)											公制螺栓	美制螺栓	C	SS
90TCj-S12-08	1/2	13	12S	12.0	30.2	50.0	42.5	6.7	44.0	58.5	22	24	M 08x25	5/16x1 1/4	210	210
90TCj-L15-08	1/2	13	15L	12.0	30.2	36.0	29.0	6.7	36.0	44.0	24	27	M08x25	5/16x1 1/4	315	315
90TCj-S16-08	1/2	13	16S	12.0	30.2	38.0	29.5	6.7	36.0	48.0	24	30	M 08x25	5/16x1 1/4	350	350
90TCj-L18-08	1/2	13	18L	12.0	30.2	50.0	42.5	6.7	44.0	59.0	22	32	M 08x25	5/16x1 1/4	315	315
90TCj-S16-12	3/4	19	16S	19.0	38.1	64.0	55.5	6.7	53.0	73.5	27	30	M10x30	3/8x1 1/4	350	350
90TCj-L18-12	3/4	19	18L	19.0	38.1	39.0	31.5	6.7	42.0	48.0	30	32	M10x30	3/8x1 1/4	315	315
90TCj-L22-12	3/4	19	22L	19.0	38.1	41.0	33.5	6.7	42.0	50.0	30	36	M10x30	3/8x1 1/4	160	160
90TCj-S20-12	3/4	19	20S	17.0	38.1	43.0	32.5	6.7	42.0	54.0	30	36	M10x30	3/8x1 1/4	350	350
90TCj-S25-12	3/4	19	25S	17.0	38.1	45.0	33.0	6.7	42.0	57.0	30	46	M10x30	3/8x1 1/4	350	350
90TCj-S20-16	1	25	20S	20.0	44.5	65.0	54.5	8.0	60.0	77.0	34	36	M10x30	3/8x1 1/4	350	350
90TCj-L22-16	1	25	22L	18.0	44.5	65.0	57.5	8.0	60.0	74.0	34	36	M10x30	3/8x1 1/4	160	160
90TCj-L28-16	1	25	28L	25.0	44.5	44.0	36.5	8.0	45.0	53.0	36	41	M10x30	3/8x1 1/4	160	160
90TCj-S25-16	1	25	25S	20.0	44.5	48.0	36.5	8.0	45.0	57.0	36	46	M10x30	3/8x1 1/4	350	350
90TCj-S30-16	1	25	30S	24.0	44.5	50.0	36.5	8.0	45.0	63.0	36	50	M10x30	3/8x1 1/4	250	250
90TCj-L35-20-F	1 1/4	32	35L	32.0	50.8	57.0	46.5	8.0	50.0	68.0	41	50	M10x35	3/8x1 1/4	160	160
90TCj-S25-20-F	1 1/4	32	25S	27.0	50.8	55.0	43.0	8.0	60.0	67.0	41	46	M10x35	3/8x1 1/4	200	200
90TCj-S30-20-F	1 1/4	32	30S	28.0	50.8	57.0	43.5	8.0	50.0	70.0	41	50	M10x35	3/8x1 1/4	200	200
90TCj-S38-20-F	1 1/4	32	38S	28.0	50.8	59.0	43.0	8.0	50.0	74.0	46	60	M 10x35	3/8x1 1/4	200	200
90TCj-L35-20	1 1/4	32	35L	32.0	50.8	57.0	46.5	8.0	50.0	68.0	41	50	M12x40	7/16x1 1/2	160	160
90TCj-S25-20	1 1/4	32	25S	27.0	50.8	55.0	43.0	8.0	50.0	67.0	41	46	M12x40	7/16x1 1/2	200	200
90TCj-S30-20	1 1/4	32	30S	28.0	50.8	57.0	43.5	8.0	50.0	70.0	41	50	M12x40	7/16x1 1/2	200	200
90TCj-S38-20	1 1/4	32	38S	28.0	50.8	59.0	43.0	8.0	50.0	74.0	41	60	M12x40	7/16x1 1/2	200	200
90TCj-L35-24	1 1/2	38	35L	30.0	60.3	78.0	67.5	8.0	66.0	83.0	50	50	M12x35	1/2x1 1/2	160	160
90TCj-L42-24	1 1/2	38	42L	36.0	60.3	58.0	47.0	8.0	55.0	70.0	50	60	M12x35	1/2x1 1/2	160	160
90TCj-S38-24	1 1/2	38	38S	36.0	60.3	64.0	48.0	8.0	55.0	79.0	50	60	M12x35	1/2x1 1/2	200	200

订货示例:

碳钢, 无六价铬镀锌: 90TCj-S12-08

304不锈钢: 90TCj-S12-08-304

316不锈钢: 90TCj-S12-08-316

注: 订货号不含螺母卡套

注: 订货号含螺母卡套 90TCj-S12-08-NBR

90TCd 法兰90°弯头

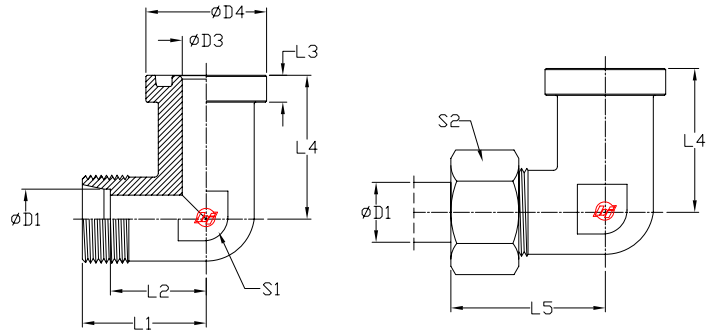

6000PSI系列

订货号	法兰尺寸 SAE ISO		D1	D3	D4	L1	L2	L3	L4	L5	S1	S2	螺栓		PN(bar)	
	(in.)	(DN)											公制螺栓	美制螺栓	C	SS
90TCd-S12-08	1/2	13	12S	12.0	31.8	50.0	42.5	7.7	44.0	58.5	22	24	M 08x30	5/16x1 1/4	420	420
90TCd-S14-08	1/2	13	14S	12.0	31.8	50.0	42.0	7.7	44.0	59.5	22	27	M 08x30	5/16x1 1/4	420	420
90TCd-S16-08	1/2	13	16S	12.0	31.8	38.0	29.5	7.7	39.0	48.0	24	30	M 08x30	5/16x1 1/4	420	420
90TCd-S16-12	3/4	19	16S	17.0	41.3	45.0	36.5	8.7	48.0	55.0	32	30	M10x35	3/8x1 1/2	420	420
90TCd-S20-12	3/4	19	20S	17.0	41.3	46.0	35.5	8.7	48.0	57.0	32	36	M10x35	3/8x1 1/2	420	400
90TCd-S25-12	3/4	19	25S	17.0	41.3	48.0	36.0	8.7	48.0	60.0	32	46	M10x35	3/8x1 1/2	420	400
90TCd-S20-16	1	25	20S	16.0	47.6	65.0	54.5	9.5	62.0	75.0	34	36	M12x45	7/16x1 3/4	420	400
90TCd-S25-16	1	25	25S	20.0	47.6	53.0	44.0	9.5	60.0	65.0	41	46	M12x45	7/16x1 3/4	420	400
90TCd-S30-16	1	25	30S	25.0	47.6	55.0	41.5	9.5	60.0	68.0	41	50	M12x45	7/16x1 3/4	420	400
90TCd-S25-20-F	1 1/4	32	25S	25.0	54.0	64.0	52.0	10.2	55.0	76.0	42	46	M12x45	7/16x1 1/2	420	400
90TCd-S30-20-F	1 1/4	32	30S	30.0	54.0	58.0	44.5	10.2	68.0	71.0	46	50	M12x45	7/16x1 1/2	420	400
90TCd-S38-20-F	1 1/4	32	38S	30.0	54.0	61.0	45.0	10.2	68.0	76.0	46	60	M12x45	7/16x1 1/2	315	315
90TCd-S25-20	1 1/4	32	25S	25.0	54.0	64.0	52.0	10.2	55.0	76.0	42	46	M14x50	1/2x1 3/4	420	400
90TCd-S30-20	1 1/4	32	30S	30.0	54.0	58.0	44.5	10.2	68.0	71.0	46	50	M14x50	1/2x1 3/4	420	400
90TCd-S38-20	1 1/4	32	38S	30.0	54.0	61.0	45.0	10.2	68.0	76.0	46	60	M14x50	1/2x1 3/4	315	315
90TCd-S30-24	1 1/2	38	30S	25.0	63.5	76.0	63.5	12.5	77.0	90.0	50	50	M16x55	5/8x2 1/4	420	400
90TCd-S38-24	1 1/2	38	38S	32.0	63.5	72.0	56.0	12.5	76.0	87.0	50	60	M16x55	5/8x2 1/4	315	315

订货示例:

碳钢, 无六价铬镀锌: 90TCd-S12-08

304不锈钢: 90TCd-S12-08-304

316不锈钢: 90TCd-S12-08-316

注: 订货号不含螺母卡套

注: 订货号含螺母卡套 90TCd-S12-08-NBR

00CjWt 焊接法兰直接头

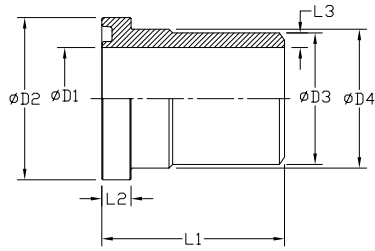

带O型圈表面

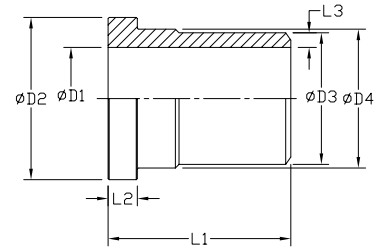

平面(见说明)

3000PSI系列

订货号	法兰尺寸		钢管	D1	D2	D3	D4	L1	L2	L3	PN(bar)	
	(in.)	(DN)									C	SS
00CjWt-08-15.0X2.0	1/2	13	15.0x2.0	11.0	30.2	15.0	23.9	45.0	6.8	2.0	345	345
00CjWt-08-16.0X3.0	1/2	13	16.0x3.0	10.0	30.2	16.0	23.9	45.0	6.8	3.0	345	345
00CjWt-08-21.3X2.6	1/2	13	21.3x2.6	13.0	30.2	22.0	23.9	45.0	6.8	4.5	345	345
00CjWt-12-18.0X1.5	3/4	19	18.0x1.5	15.0	38.1	18.0	31.5	49.9	6.8	1.5	345	345
00CjWt-12-22.0X2.0	3/4	19	22.0x2.0	18.0	38.1	22.0	31.5	49.9	6.8	2.0	345	345
00CjWt-12-20.0X3.0	3/4	19	20.0x3.0	14.0	38.1	20.0	31.5	49.9	6.8	3.0	345	345
00CjWt-12-25.0X4.0	3/4	19	25.0x4.0	17.0	38.1	25.0	31.5	49.9	6.8	4.0	345	345
00CjWt-12-26.9X2.6	3/4	19	26.9x2.6	19.0	38.1	28.0	31.5	50.0	6.7	4.5	345	345
00CjWt-16-20.0X2.5	1	25	20.0x2.5	15.0	44.5	20.0	38.0	55.0	8.0	2.5	345	345
00CjWt-16-28.0X2.0	1	25	28.0x2.0	24.0	44.5	28.0	38.0	55.0	8.0	2.0	345	345
00CjWt-16-30.0X4.5	1	25	30.0x4.5	21.0	44.5	30.0	38.0	55.0	8.0	4.5	345	345
00CjWt-16-33.7X4.0	1	25	33.7x4.0	25.0	44.4	35.0	38.0	55.0	8.0	5.0	345	345
00CjWt-20-35.0X2.0	1 1/4	32	35.0x2.0	31.0	50.8	35.0	43.0	60.0	8.0	2.0	276	276
00CjWt-20-25.0X3.0	1 1/4	32	25.0x3.0	19.0	50.8	25.0	43.0	60.0	8.0	3.0	276	276
00CjWt-20-30.0X4.0	1 1/4	32	30.0x4.0	22.0	50.8	30.0	43.0	60.0	8.0	4.0	276	276
00CjWt-20-38.0X5.0	1 1/4	32	38.0x5.0	28.0	50.8	38.0	43.0	60.0	8.0	5.0	276	276
00CjWt-20-42.4X6.0	1 1/4	32	42.4x6.0	31.0	50.8	43.0	43.0	60.0	8.0	6.0	276	276
00CjWt-24-42.0X3.0	1 1/2	38	42.0x3.0	36.0	60.3	42.0	50.0	64.9	8.0	3.0	207	207
00CjWt-24-38.0X4.0	1 1/2	38	38.0x4.0	30.0	60.3	38.0	50.0	64.9	8.0	4.0	207	207
00CjWt-24-48.3X6.0	1 1/2	38	48.3x6.0	38.0	60.3	50.0	50.0	65.0	8.0	6.0	207	207
00CjWt-32-50.0X6.0	2	51	50.0x6.0	38.0	71.4	50.0	62.0	70.0	9.6	6.0	207	207
00CjWt-32-65.0X8.0	2	51	65.0x8.0	49.0	71.4	65.0	62.0	70.0	9.6	8.0	207	207
00CjWt-32-60.3X7.5	2	51	60.3x7.5	47.0	71.4	62.0	62.0	70.0	9.5	7.5	207	207
00CjWt-40-76.1X5.5	2 1/2	64	76.1x5.5	63.0	84.1	74.0	74.0	75.0	9.5	5.5	172	172
00CjWt-48-88.9X10.0	3	76	88.9x10.0	70.0	101.6	90.0	90.0	85.0	9.5	10.0	138	138
00CjWt-56-101.6X7.0	3 1/2	89	101.6x7.0	88.0	114.3	102.0	102.0	90.0	11.2	7.0	34	34
00CjWt-64-114.0X8.5	4	102	114.0x8.5	98.0	127.0	114.0	114.0	100.0	11.2	8.0	34	34
00CjWt-80-139.7X10.0	5	127	139.7x10.0	120.0	152.4	140.0	140.0	100.0	11.2	10.0	34	34

订货示例:

(1) 法兰有密封槽

碳钢, 无六价铬镀锌: 00CjWt-08-15.0X2.0

304不锈钢: 00CjWt-08-15.0X2.0-304

316不锈钢: 00CjWt-08-15.0X2.0-316

(2) 法兰无密封槽

碳钢, 无六价铬镀锌: 00CjWt-08-15.0X2.0-X

304不锈钢: 00CjWt-08-15.0X2.0-304-X

316不锈钢: 00CjWt-08-16.0X3.0-316-X

00CdWt 焊接法兰直接头

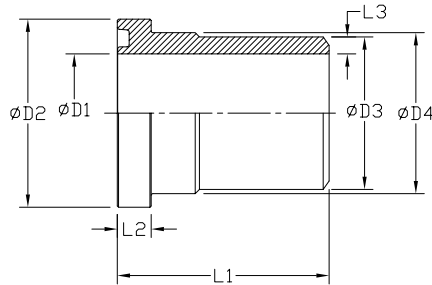

带O型圈表面

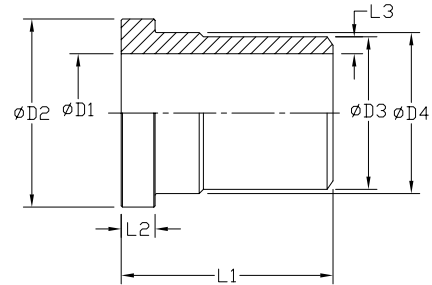

平面(见说明)

6000PSI系列

订货号	法兰尺寸		钢管	D1	D2	D3	D4	L1	L2	L3	PN(bar)	
	SAE (in.)	ISO (DN)									C	SS
00CdWt-08-16.0X3.0	1/2	13	16.0x3.0	10.0	31.8	16.0	24.0	45.0	7.8	3.0	420	420
00CdWt-08-21.3X3.2	1/2	13	21.3x3.2	13.0	31.8	22.0	24.0	45.0	7.8	4.5	420	420
00CdWt-12-16.0X3.0	3/4	19	16.0x3.0	10.0	41.3	16.0	31.8	50.0	8.8	3.0	420	420
00CdWt-12-20.0X4.0	3/4	19	20.0x4.0	12.0	41.3	20.0	31.8	50.0	8.8	4.0	420	420
00CdWt-12-26.9X4.0	3/4	19	26.9x4.0	18.0	41.3	28.0	32.0	50.0	8.8	5.0	420	420
00CdWt-12-25.0X5.0	3/4	19	25.0x5.0	15.0	41.3	25.0	31.8	50.0	8.8	5.0	420	420
00CdWt-16-25.0X5.0	1	25	25.0x5.0	15.0	47.6	25.0	38.0	55.0	9.5	5.0	420	420
00CdWt-16-30.0X4.0	1	25	30.0x4.0	22.0	47.6	30.0	38.0	55.0	9.5	4.0	420	420
00CdWt-16-30.0X6.0	1	25	30.0x6.0	18.0	47.3	30.0	38.0	67.0	9.5	6.0	420	420
00CdWt-16-33.7X6.3	1	25	33.7x6.3	22.0	47.6	35.0	38.0	55.0	9.5	6.5	420	420
00CdWt-20-30.0X4.0	1 1/4	32	30.0x4.0	22.0	54.0	30.0	44.0	60.0	10.3	4.0	420	420
00CdWt-20-30.0X6.0	1 1/4	32	30.0x6.0	18.0	54.0	30.0	44.0	60.0	10.3	6.0	420	420
00CdWt-20-38.0X5.0	1 1/4	32	38.0x5.0	28.0	54.0	38.0	44.0	60.0	10.3	5.0	420	420
00CdWt-20-38.0X8.0	1 1/4	32	38.0x8.0	22.0	54.0	38.0	44.0	60.0	10.3	8.0	420	420
00CdWt-20-42.4X6.3	1 1/4	32	42.4x6.3	29.0	54.0	44.0	44.0	60.0	10.3	7.5	420	420
00CdWt-24-38.0X5.0	1 1/2	38	38.0x5.0	28.0	63.5	38.0	50.8	65.0	12.6	5.0	420	420
00CdWt-24-38.0X8.0	1 1/2	38	38.0x8.0	22.0	63.5	38.0	50.8	65.0	12.6	8.0	420	420
00CdWt-24-48.3X8.0	1 1/2	38	48.3x8.0	35.0	63.5	51.0	51.0	65.0	12.6	8.0	420	420
00CdWt-32-50.0X9.0	2	51	50.0x9.0	32.0	79.4	50.0	66.6	70.0	12.6	9.0	420	420
00CdWt-32-65.0X8.0	2	51	65.0x8.0	49.0	79.4	65.0	66.6	70.0	12.6	8.0	420	420
00CdWt-32-60.3X10	2	51	60.3x10.0	43.0	79.4	61.0	67.0	70.0	12.6	9.0	420	420
00CdWt-40-73X14.0	2 1/2	64	73.0x14.0	45.0	107.8	74.0	88.9	90.0	20.6	14.5	420	420
00CdWt-48-88.6X16	3	76	88.6x16.0	58.0	131.7	90.0	113.8	110.0	25.6	16.0	420	420

订货示例:

(1) 法兰有密封槽

碳钢, 无六价铬镀锌: 00CdWt-08-16.0X3.0

304不锈钢: 00CdWt-08-16.0X3.0-304

316不锈钢: 00CdWt-08-16.0X3.0-316

(2) 法兰无密封槽

碳钢, 无六价铬镀锌: 00CdWt-08-16.0X3.0-X

304不锈钢: 00CdWt-08-16.0X3.0-304-X

316不锈钢: 00CdWt-08-16.0X3.0-316-X

00ZpSj 插入式JIC37°内螺纹软管接头

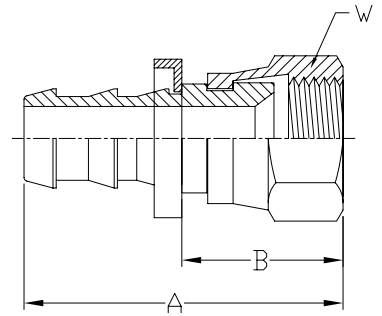

订货号	螺纹UNF		软管内径		尺寸 DIMENSIONS		
			DN	inch	A	B	W
00ZpSj-04-04	1/4	7/16-20	6	1/4	39	20	9/16
00ZpSj-06-06	3/8	9/16-18	10	3/8	44	22	11/16
00ZpSj-08-08	1/2	3/4-16	12	1/2	51	25	7/8
00ZpSj-10-10	5/8	7/8-14	16	5/8	65	28	1
00ZpSj-12-12	3/4	1 1/16-12	20	3/4	67	30	1-1/4

碳钢, 无六价铬镀锌: 00ZpSj-04-04

304不锈钢: 00ZpSj-04-04-304

316不锈钢: 00ZpSj-04-04-316

铜: 00ZpSj-04-04-B

00ZpSr 插入式24°锥内螺纹软管接头

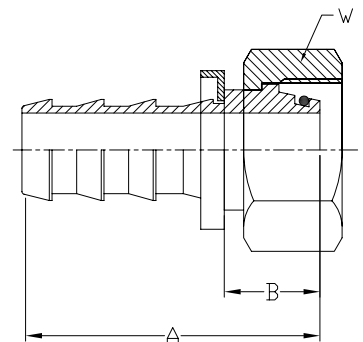

订货号	公制螺纹		软管内径		尺寸 DIMENSIONS		
			DN	inch	A	B	W
00ZpSr-04-L06	6	M12x1.5	6	1/4	40	21	14
00ZpSr-04-L08	8	M14x1.5	6	1/4	36	17	17
00ZpSr-06-L10	10	M16x1.5	10	3/8	40	17	19
00ZpSr-06-L12	12	M18x1.5	10	3/8	40	17	22
00ZpSr-08-L15	15	M22x1.5	12	1/2	44	18	27
00ZpSr-10-L18	18	M26x1.5	16	5/8	56	19	32
00ZpSr-12-L22	22	M30x2.0	20	3/4	58	21	36

订货示例:

碳钢, 无六价铬镀锌: 00ZpSr-04-L06

304不锈钢: 00ZpSr-04-L06-304

316不锈钢: 00ZpSr-04-L06-316

铜: 00ZpSr-04-L06-B

00R02Sr 两层胶管接头-24°锥轻系列

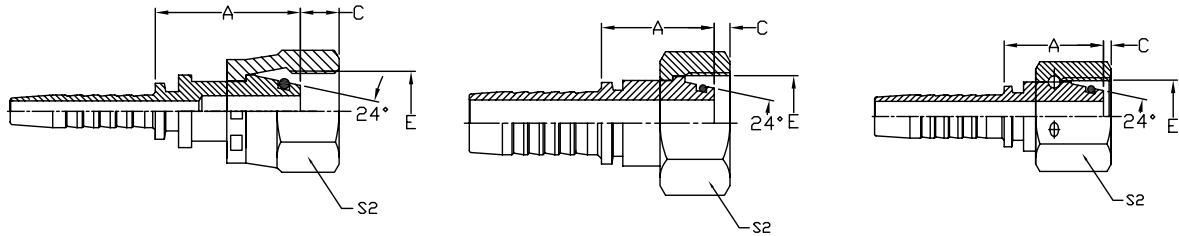

订货号	螺纹 THREAD E	胶管 HOSE BORE		管子外径 TUBE O.D.	O形圈 ORING	尺寸 DIMENSIONS		
		公称内径DN	标号DASH			A	C	S2
00R02Sr-04-L06	M12x1.5	6	04	6	4.5x1.5	26.0	1.0	17
00R02Sr-04-L08	M14x1.5	6	04	8	6.5x1.5	24.0	2.0	17
00R02Sr-06-L08	M14x1.5	10	06	8	6.5x1.5	27.5	2.0	19
00R02Sr-04-L10	M16x1.5	6	04	10	8.0x1.5	23.0	2.0	19
00R02Sr-05-L10	M16x1.5	8	05	10	8.0x1.5	24.0	2.0	19
00R02Sr-06-L10	M16x1.5	10	06	10	8.0x1.5	27.5	2.0	19
00R02Sr-05-L12	M18x1.5	8	05	12	10.0x1.5	24.5	1.5	22
00R02Sr-06-L12	M18x1.5	10	06	12	10.0x1.5	25.0	2.5	22
00R02Sr-08-L12	M18x1.5	13	08	12	10.0x1.5	29.5	2.5	24
00R02Sr-05-L15	M22x1.5	8	05	15	12.0x2.0	26.5	3.0	24
00R02Sr-06-L15	M22x1.5	10	06	15	12.0x2.0	26.5	3.0	27
00R02Sr-08-L15	M22x1.5	13	08	15	12.0x2.0	28.0	2.5	27
00R02Sr-10-L18	M26x1.5	16	10	18	15.0x2.0	28.8	2.5	27
00R02Sr-12-L18	M26x1.5	19	12	18	15.0x2.0	26.5	2.5	36
00R02Sr-10-L22	M30x2.0	16	10	22	20.0x2.0	31.0	3.8	36
00R02Sr-12-L22	M30x2.0	19	12	22	20.0x2.0	33.0	4.0	36
00R02Sr-12-L28	M36x2.0	19	12	28	26.0x2.0	33.0	4.5	41
00R02Sr-16-L35	M45x2.0	25	16	35	32.0x2.5	37.0	4.0	55
00R02Sr-20-L35	M45x2.0	32	20	35	32.0x2.5	37.5	4.0	55
00R02Sr-20-L42	M52x2.0	32	20	42	38.0x2.5	38.5	4.0	60
00R02Sr-24-L42	M52x2.0	38	24	42	38.0x2.5	38.5	4.0	60

订货示例:

碳钢, 无六价铬镀锌: 00R02Sr-04-L06

304不锈钢: 00R02Sr-04-L06-304

316不锈钢: 00R02Sr-04-L06-316

如需用于四层钢丝软管, 订货号改为: 00R04Sr-04-L06

00R02Sr 两层胶管接头-24°锥重系列

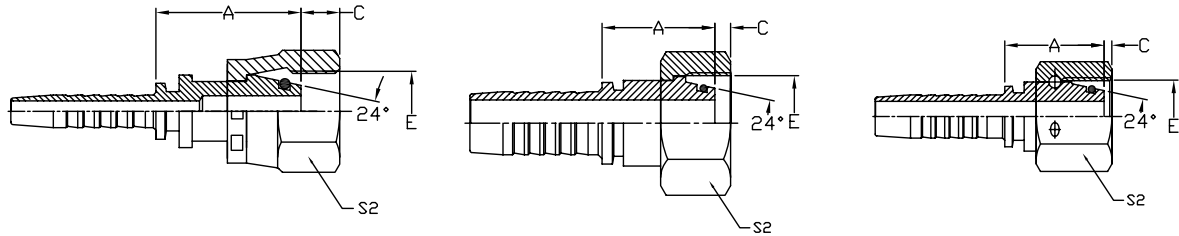

订货号	螺纹E THREAD E	胶管 HOSE BORE		管子外径 TUBE O.D.	O形圈 ORING	尺寸 DIMENSIONS		
		公称内径DN	标号DASH			A	C	S2
00R02Sr-04-S06	M14x1.5	6	04	6	4.5x1.5	25.0	1.5	17
00R02Sr-04-S08	M16x1.5	6	04	8	6.5x1.5	24.5	1.5	19
00R02Sr-05-S08	M16x1.5	8	05	8	6.5x1.5	25.0	1.5	19
00R02Sr-04-S10	M18x1.5	6	04	10	8.0x1.5	25.5	1.5	22
00R02Sr-06-S10	M18x1.5	10	06	10	8.0x1.5	26.5	2.0	22
00R02Sr-06-S12	M20x1.5	10	06	12	10.0x1.5	26.5	2.5	24
00R02Sr-08-S12	M20x1.5	13	08	12	10.0x1.5	31.5	2.5	27
00R02Sr-06-S14	M22x1.5	10	06	14	11.0x2.0	26.5	3.0	27
00R02Sr-08-S14	M22x1.5	13	08	14	11.0x2.0	29.0	2.5	27
00R02Sr-06-S16	M24x1.5	10	06	16	13.0x2.0	27.0	3.0	30
00R02Sr-08-S16	M24x1.5	13	08	16	13.0x2.0	27.5	3.0	30
00R02Sr-10-S20	M30x2.0	16	10	20	16.3x2.4	33.0	2.5	36
00R02Sr-12-S20	M30x2.0	19	12	20	16.3x2.4	34.5	3.0	36
00R02Sr-12-S25	M36x2.0	19	12	25	20.3x2.4	35.0	3.2	46
00R02Sr-16-S30	M42x2.0	25	16	30	25.3x2.4	38.5	3.9	50
00R02Sr-20-S38	M52x2.0	32	20	38	33.3x2.4	41.5	4.5	60
00R02Sr-24-S38	M52x2.0	38	24	38	33.3x2.4	41.5	4.5	60

订货示例:

碳钢, 无六价铬镀锌: 00R02Sr-04-S06

304不锈钢: 00R02Sr-04-S06-304

316不锈钢: 00R02Sr-04-S06-316

如需用于四层钢丝软管, 订货号改为: 00R04Sr-04-S06

00R02Sb 两层胶管接头-BSP 60°锥

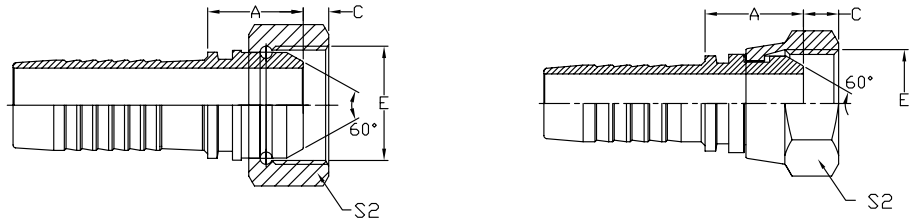

订货号	螺纹E THREAD E	胶管 HOSE BORE		尺寸 DIMENSIONS		
		公称内径DN	标号DASH	A	C	S2
00R02Sb-04-04	G1/4	6	04	18.0	5.5	19
00R02Sb-05-04	G1/4	8	05	18.0	5.5	19
00R02Sb-06-04	G1/4	10	06	18.0	5.5	19
00R02Sb-04-06	G3/8	6	04	19.0	6.3	22
00R02Sb-05-06	G3/8	8	05	19.0	6.3	22
00R02Sb-06-06	G3/8	10	06	19.5	6.3	22
00R02Sb-08-06	G3/8	13	08	19.5	6.3	22
00R02Sb-06-08	G1/2	10	06	21.0	7.5	27
00R02Sb-08-08	G1/2	13	08	21.5	7.5	27
00R02Sb-08-10	G5/8	13	08	22.0	9.5	30
00R02Sb-10-10	G5/8	16	10	23.0	9.5	30
00R02Sb-08-12	G3/4	13	08	22.0	10.9	32
00R02Sb-10-12	G3/4	16	10	24.5	10.9	32
00R02Sb-12-12	G3/4	19	12	24.5	10.9	32
00R02Sb-12-16	G1	19	12	24.0	11.7	41
00R02Sb-16-16	G1	25	16	27.5	11.7	41
00R02Sb-16-20	G1 1/4	25	16	27.5	11.0	50
00R02Sb-20-20	G1 1/4	32	20	30.5	11.0	50
00R02Sb-20-24	G1 1/2	32	20	32.0	13.0	55
00R02Sb-24-24	G1 1/2	38	24	33.0	13.0	55
00R02Sb-24-32	G2	38	24	30.0	16.0	70
00R02Sb-32-32	G2	51	32	33.0	16.0	70

订货示例:

碳钢, 无六价铬镀锌: 00R02Sb-04-04

304不锈钢: 00R02Sb-04-04-304

316不锈钢: 00R02Sb-04-04-316

如需用于四层钢丝软管, 订货号改为: 00R04Sb-04-04

00R02Sj 两层胶管接头-JIC 37°锥

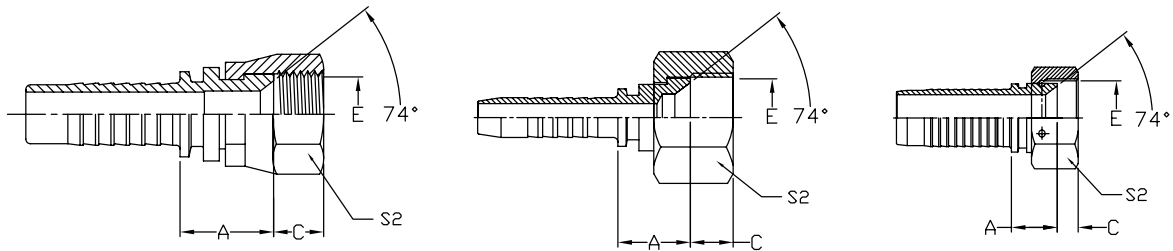

订货号	螺纹E THREAD E	胶管 HOSE BORE		尺寸 DIMENSIONS		
		公称内径DN	标号DASH	A	C	S2
00R02Sj-04-04	7/16-20	6	04	15.0	9.0	15
00R02Sj-04-06	9/16-18	6	04	15.5	10.5	19
00R02Sj-06-06	9/16-18	10	06	15.5	10.5	19
00R02Sj-08-06	9/16-18	13	08	16.0	10.5	19
00R02Sj-06-08	3/4-16	10	06	17.5	11.0	24
00R02Sj-08-08	3/4-16	13	08	18.5	11.0	24
00R02Sj-10-08	3/4-16	16	10	19.0	11.0	24
00R02Sj-08-10	7/8-14	13	08	19.0	13.0	27
00R02Sj-10-10	7/8-14	16	10	19.5	13.0	27
00R02Sj-12-10	7/8-14	19	12	20.0	13.0	27
00R02Sj-08-12	1 1/16-12	13	08	19.0	15.0	32
00R02Sj-10-12	1 1/16-12	16	10	22.0	15.0	32
00R02Sj-12-12	1 1/16-12	19	12	22.0	15.0	32
00R02Sj-16-12	1 1/16-12	25	16	23.0	15.0	32
00R02Sj-12-16	1 5/16-12	19	12	18.5	16.0	41
00R02Sj-16-16	1 5/16-12	25	16	26.0	16.0	41
00R02Sj-20-16	1 5/16-12	32	20	24.0	16.0	41
00R02Sj-16-20	1 5/8-12	25	16	23.0	17.0	50
00R02Sj-20-20	1 5/8-12	32	20	26.5	17.0	50
00R02Sj-20-24	1 7/8-12	32	20	25.0	20.0	55
00R02Sj-24-24	1 7/8-12	38	24	30.5	20.0	55
00R02Sj-24-32	2 1/2-12	38	24	27.0	23.5	75
00R02Sj-32-32	2 1/2-12	51	32	27.0	23.5	75

订货示例:

碳钢, 无六价铬镀锌: 00R02Sj-04-04

304不锈钢: 00R02Sj-04-04-304

316不锈钢: 00R02Sj-04-04-316

如需用于四层钢丝软管, 订货号改为: 00R04Sj-04-04

00R02Cj 两层胶管接头-直通法兰轻系列

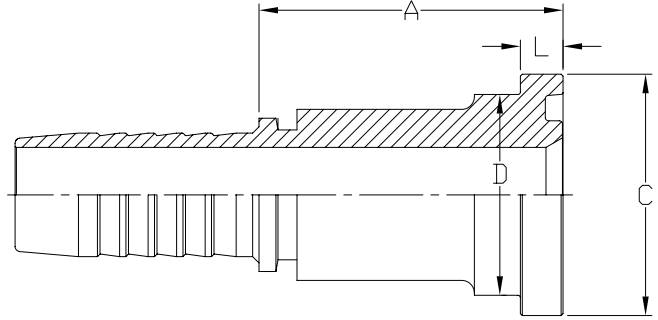

订货号	法兰型号 FLANGE SIZE	胶管HOSE BORE		尺寸 DIMENSIONS			
		公称内径DN	标号DASH	A	C	D	L
00R02Cj-08-08	1/2	13	08	46.0	30.2	24.0	6.73
00R02Cj-08-12	3/4	13	08	47.0	38.1	31.7	6.73
00R02Cj-10-12	3/4	16	10	47.5	38.1	31.7	6.73
00R02Cj-12-12	3/4	19	12	48.0	38.1	31.7	6.73
00R02Cj-16-12	3/4	25	16	49.0	38.1	31.7	6.73
00R02Cj-12-16	1	19	12	51.0	44.4	38.0	8.00
00R02Cj-16-16	1	25	16	52.0	44.4	38.0	8.00
00R02Cj-20-16	1	32	20	53.0	44.4	38.0	8.00
00R02Cj-16-20	1 1/4	25	16	57.0	50.8	43.0	8.00
00R02Cj-20-20	1 1/4	32	20	58.0	50.8	43.0	8.00
00R02Cj-20-24	1 1/2	32	20	68.0	60.3	50.0	8.00
00R02Cj-24-24	1 1/2	38	24	68.0	60.3	50.0	8.00
00R02Cj-24-32	2	38	24	70.0	71.4	62.0	9.53
00R02Cj-32-32	2	51	32	70.0	71.4	62.0	9.53
00R02Cj-40-40	2 1/2	64	40	76.0	84.1	74.0	9.53

订货示例:

碳钢, 无六价铬镀锌: 00R02Cj-08-08

304不锈钢: 00R02Cj-08-08-304

316不锈钢: 00R02Cj-08-08-316

如需用于四层钢丝软管, 订货号改为: 00R04Cj-08-08

00R02Cd 两层胶管接头-直通法兰重系列

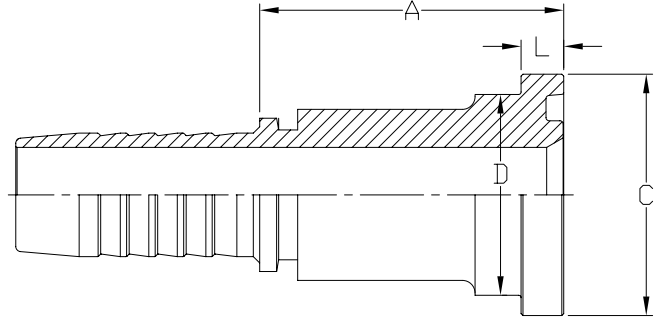

订货号	法兰型号 FLANGE SIZE	胶管HOSE BORE		尺寸 DIMENSIONS			
		公称内径DN	标号DASH	A	C	D	L
00R02Cd-08-08	1/2	13	08	47.0	31.7	24	7.75
00R02Cd-10-12	3/4	16	10	50.5	41.3	32	8.76
00R02Cd-12-12	3/4	19	12	51.0	41.3	32	8.76
00R02Cd-12-16	1	19	12	56.0	47.6	38	9.53
00R02Cd-16-16	1	25	16	57.0	47.6	38	9.53
00R02Cd-20-16	1	32	20	64.0	47.6	38	9.53
00R02Cd-16-20	1 1/4	25	16	65.0	54.0	44	10.29
00R02Cd-20-20	1 1/4	32	20	66.0	54.0	44	10.29
00R02Cd-20-24	1 1/2	32	20	75.0	63.5	51	12.57
00R02Cd-24-24	1 1/2	38	24	75.0	63.5	51	12.57
00R02Cd-24-32	2	38	24	85.0	79.4	67	12.57
00R02Cd-32-32	2	51	32	85.0	79.4	67	12.57

订货示例:

碳钢, 无六价铬镀锌: 00R02Cd-08-08

304不锈钢: 00R02Cd-08-08-304

316不锈钢: 00R02Cd-08-08-316

如需用于四层钢丝软管, 订货号改为: 00R04Cd-08-08

45R02Sr 两层胶管接头-24°锥轻系列

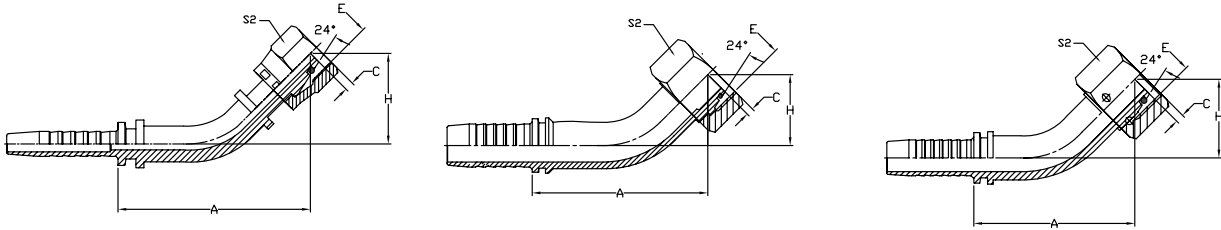

订货号	螺纹E THREAD E	胶管HOSE BORE		管子外径 TUBE O.D.	O型圈 O RING	PN(bar)			
		公称内径DN	标号DASH			A	C	H	S2
45R02Sr-04-L08	M14x1.5	6	04	8	6.5x1.5	37.0	2.0	16.5	17
45R02Sr-05-L10	M16x1.5	8	05	10	8.0x1.5	40.0	2.0	19.5	19
45R02Sr-06-L10	M16x1.5	10	06	10	8.0x1.5	40.0	2.0	20.5	22
45R02Sr-05-L12	M18x1.5	8	05	12	10.0x1.5	46.0	1.5	23.0	22
45R02Sr-06-L12	M18x1.5	10	06	12	10.0x1.5	42.0	2.5	20.0	22
45R02Sr-06-L15	M22x1.5	10	06	15	12.0x2.0	48.5	3.0	24.2	27
45R02Sr-08-L15	M22x1.5	13	08	15	12.0x2.0	61.0	2.5	25.0	27
45R02Sr-08-L18	M26x1.5	13	08	18	15.0x2.0	60.5	2.1	26.0	32
45R02Sr-10-L18	M26x1.5	16	10	18	15.0x2.0	65.0	2.5	26.0	32
45R02Sr-12-L18	M26x1.5	19	12	18	15.0x2.0	61.0	2.5	26.0	36
45R02Sr-10-L22	M30x2.0	16	10	22	20.0x2.0	66.5	3.8	27.5	36
45R02Sr-12-L22	M30x2.0	19	12	22	20.0x2.0	74.0	4.0	29.0	36
45R02Sr-12-L28	M36x2.0	19	12	28	26.0x2.0	74.5	4.5	29.5	41
45R02Sr-20-L35	M45x2.0	32	20	35	32.0x2.5	100.0	4.0	39.5	55
45R02Sr-20-L42	M52x2.0	32	20	42	38.0x2.5	100.5	4.0	40.0	60
45R02Sr-24-L42	M52x2.0	38	24	42	38.0x2.5	119.0	4.0	43.0	60

订货示例:

碳钢, 无六价铬镀锌: 45R02Sr-04-L08

304不锈钢: 45R02Sr-04-L08-304

316不锈钢: 45R02Sr-04-L08-316

如需用于四层钢丝软管, 订货号改为: 45R04Sr-04-L08

45R02Sr 两层胶管接头-24°锥重系列

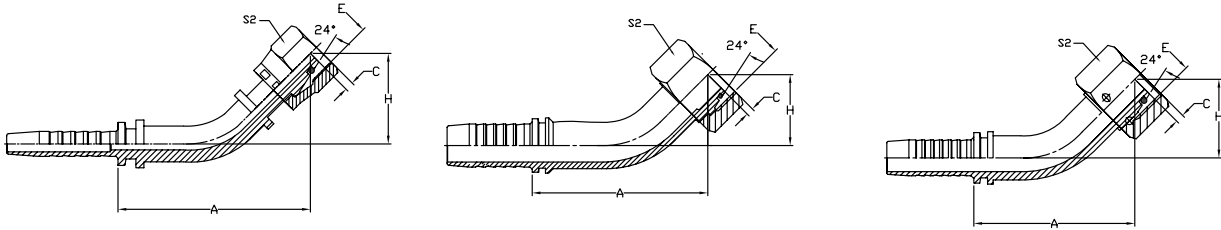

订货号	螺纹E THREAD E	胶管HOSE BORE		管子外径 TUBE O.D.	O型圈	PN(bar)			
		公称内径DN	标号DASH		O RING	A	C	H	S2
45R02Sr-04-S06	M14x1.5	6	04	6	4.5x1.5	39.6	1.5	19.7	17
45R02Sr-04-S08	M16x1.5	6	04	8	6.5x1.5	38.4	1.5	16.3	19
45R02Sr-05-S08	M16x1.5	8	05	8	6.5x1.5	37.6	1.5	17.7	19
45R02Sr-04-S10	M18x1.5	6	04	10	8.0x1.5	43.7	1.5	21.6	22
45R02Sr-06-S10	M18x1.5	10	06	10	8.0x1.5	47.0	2.0	22.2	22
45R02Sr-06-S12	M20x1.5	10	06	12	10.0x1.5	40.7	2.5	23.3	24
45R02Sr-08-S12	M20x1.5	13	08	12	10.0x1.5	46.3	2.5	21.9	27
45R02Sr-06-S14	M22x1.5	10	06	14	11.0x2.0	48.1	3.0	23.9	27
45R02Sr-08-S14	M22x1.5	13	08	14	11.0x2.0	60.4	2.5	24.7	27
45R02Sr-08-S16	M24x1.5	13	08	16	13.0x2.0	60.7	3.0	25.8	30
45R02Sr-10-S20	M30x2.0	16	10	20	16.3x2.4	68.0	2.5	28.1	36
45R02Sr-12-S20	M30x2.0	19	12	20	16.3x2.4	71.0	3.0	28.2	36
45R02Sr-12-S25	M36x2.0	19	12	25	20.3x2.4	74.4	3.2	29.7	46
45R02Sr-16-S30	M42x2.0	25	16	30	25.3x2.4	88.4	3.9	34.8	50
45R02Sr-20-S38	M52x2.0	32	20	38	33.3x2.4	99.7	4.5	39.4	60
45R02Sr-24-S38	M52x2.0	38	24	38	33.3x2.4	111.6	4.5	42.5	60

订货示例:

碳钢, 无六价铬镀锌: 45R02Sr-04-S06

304不锈钢: 45R02Sr-04-S06-304

316不锈钢: 45R02Sr-04-S06-316

如需用于四层钢丝软管, 订货号改为: 45R04Sr-04-S06

45R02Sb 两层胶管接头-BSP60°锥

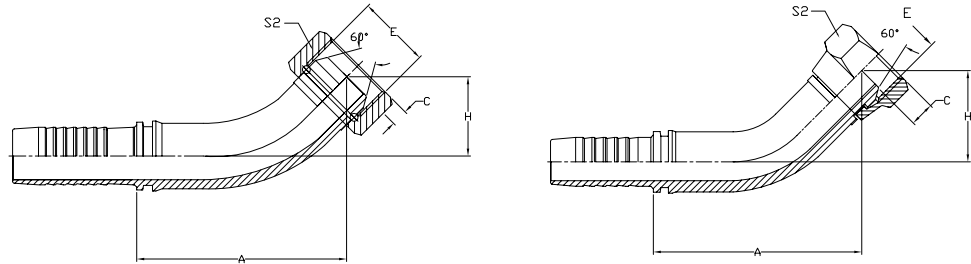

订货号	螺纹E THREAD E	胶管HOSE BORE 公称内径DN 标号DASH		尺寸 DIMENSIONS			
				A	C	H	S2
45R02Sb-04-04	G1/4	6	04	42.3	5.5	20.2	19
45R02Sb-04-06	G3/8	6	04	43.2	6.3	21.0	22
45R02Sb-06-06	G3/8	10	06	46.9	6.3	22.6	22
45R02Sb-06-08	G1/2	10	06	48.1	7.5	23.9	27
45R02Sb-08-08	G1/2	13	08	61.1	7.5	26.1	27
45R02Sb-08-10	G5/8	13	08	61.4	9.5	26.5	30
45R02Sb-10-10	G5/8	16	10	72.6	9.5	27.8	30
45R02Sb-08-12	G3/4	13	08	61.8	10.9	29.3	32
45R02Sb-10-12	G3/4	16	10	74.0	10.9	29.3	32
45R02Sb-12-12	G3/4	19	12	74.0	10.9	29.3	32
45R02Sb-12-16	G1	19	12	80.8	11.7	33.4	41
45R02Sb-16-16	G1	25	16	84.3	11.7	33.9	41
45R02Sb-16-20	G1 1/4	25	16	85.3	11.0	31.1	50
45R02Sb-20-20	G1 1/4	32	20	98.8	11.0	38.0	50
45R02Sb-24-24	G1 1/2	38	24	114.7	13.0	44.6	55
45R02Sb-32-32	G2	51	32	141.2	16.0	52.7	70

订货示例:

碳钢, 无六价铬镀锌: 45R02Sb-04-04

304不锈钢: 45R02Sb-04-04-304

316不锈钢: 45R02Sb-04-04-316

如需用于四层钢丝软管, 订货号改为: 45R04Sb-04-04

45R02Sj 两层胶管接头-JIC37°锥

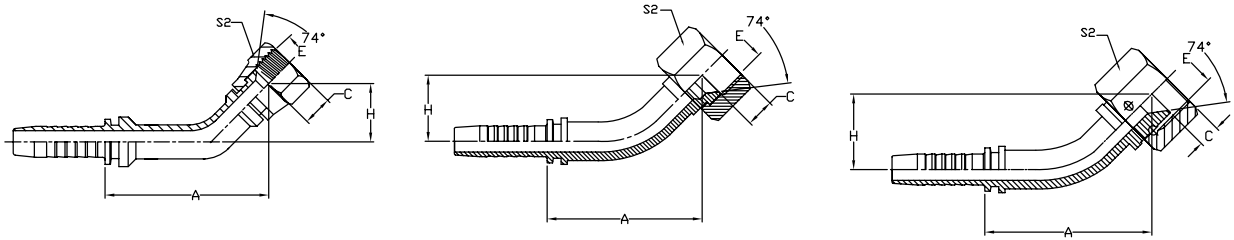

订货号	螺纹E THREAD E	胶管HOSE BORE 公称内径DN 标号DASH		尺寸 DIMENSIONS			
				A	C	H	S2
45R02Sj-04-04	7/16-20	6	04	40.2	9.0	18.1	15
45R02Sj-04-06	9/16-18	6	04	40.5	10.5	18.5	19
45R02Sj-05-06	9/16-18	8	05	42.6	10.5	19.3	19
45R02Sj-06-06	9/16-18	10	06	44.3	10.5	20.0	19
45R02Sj-06-08	3/4-16	10	06	45.7	11.0	21.4	24
45R02Sj-08-08	3/4-16	13	08	57.9	11.0	22.9	24
45R02Sj-08-10	7/8-14	13	08	58.9	13.0	24.0	27
45R02Sj-10-10	7/8-14	16	10	60.6	13.0	24.3	27
45R02Sj-12-10	7/8-14	19	12	75.7	13.0	28.9	27
45R02Sj-08-12	1 1/16-12	13	08	60.0	15.0	25.1	32
45R02Sj-10-12	1 1/16-12	16	10	72.0	15.0	27.3	32
45R02Sj-12-12	1 1/16-12	19	12	72.0	15.0	27.3	32
45R02Sj-12-16	1 5/16-12	19	12	77.4	16.0	30.0	41
45R02Sj-16-16	1 5/16-12	25	16	82.5	16.0	32.1	41
45R02Sj-20-20	1 5/8-12	32	20	95.4	17.0	35.2	50
45R02Sj-20-24	1 7/8-12	32	20	100.0	20.0	39.8	55
45R02Sj-24-24	1 7/8-12	38	24	112.9	20.0	42.8	55
45R02Sj-32-32	2 1/2-12	51	32	140.9	23.5	51.6	75

订货示例:

碳钢, 无六价铬镀锌: 45R02Sj-04-04

304不锈钢: 45R02Sj-04-04-304

316不锈钢: 45R02Sj-04-04-316

如需用于四层钢丝软管, 订货号改为: 45R04Sj-04-04

45R02Cj 两层胶管接头-45°法兰轻系列

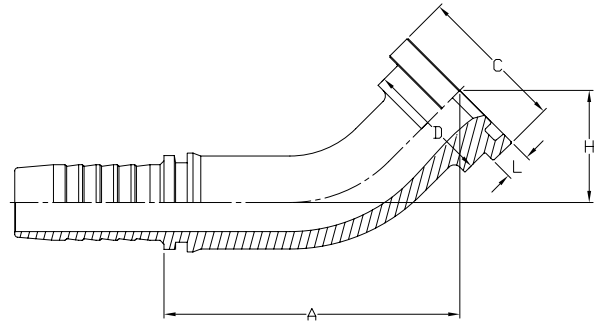

订货号	法兰型号 FLANGE SIZE	胶管HOSE BORE		尺寸 DIMENSIONS				
		公称内径DN	标号DASH	A	C	D	H	L
45R02Cj-08-08	1/2	13	08	58.2	30.2	24.0	23.3	6.73
45R02Cj-08-12	3/4	13	08	58.9	38.1	31.7	24.0	6.73
45R02Cj-10-12	3/4	16	10	69.6	38.1	31.7	25.3	6.73
45R02Cj-12-12	3/4	19	12	70.6	38.1	31.7	25.9	6.73
45R02Cj-12-16	1	19	12	76.3	44.4	38.0	28.9	8.00
45R02Cj-16-16	1	25	16	83.0	44.4	38.0	29.4	8.00
45R02Cj-20-16	1	32	20	94.5	44.4	38.0	33.8	8.00
45R02Cj-16-20	1 1/4	25	16	85.2	50.8	43.0	29.7	8.00
45R02Cj-20-20	1 1/4	32	20	94.5	50.8	43.0	33.8	8.00
45R02Cj-24-20	1 1/4	32	20	95.9	60.3	50.0	35.2	8.00
45R02Cj-24-24	1 1/2	38	24	108.3	60.3	50.0	38.3	8.00
45R02Cj-24-32	2	38	24	108.0	71.4	62.0	38.3	9.53
45R02Cj-32-32	2	51	32	134.3	71.4	62.0	46.3	9.53

订货示例:

碳钢, 无六价铬镀锌: 45R02Cj-08-08

304不锈钢: 45R02Cj-08-08-304

316不锈钢: 45R02Cj-08-08-316

如需用于四层钢丝软管, 订货号改为: 45R04Cj-08-08

45R02Cd 两层胶管接头-45°法兰重系列

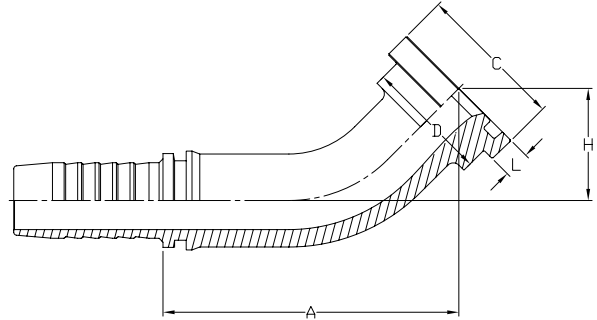

订货号	法兰型号 FLANGE SIZE	胶管HOSE BORE 公称内径DN 标号DASH		尺寸 DIMENSIONS				
				A	C	D	H	L
45R02Cd-08-08	1/2	13	08	59.0	31.7	24	24.0	7.75
45R02Cd-12-08	1/2	19	12	65.0	31.7	24	27.0	7.75
45R02Cd-10-12	3/4	16	10	72.5	41.3	32	28.0	8.76
45R02Cd-12-12	3/4	19	12	80.0	41.3	32	32.0	8.76
45R02Cd-16-16	1	25	16	89.0	47.6	38	35.0	9.53
45R02Cd-20-20	1 1/4	32	20	103.0	54.0	44	42.0	10.29
45R02Cd-20-24	1 1/2	32	20	106.0	63.5	51	45.0	12.57
45R02Cd-24-24	1 1/2	38	24	120.0	63.5	51	49.0	12.57
45R02Cd-24-32	2	38	24	125.4	79.4	67	55.0	12.57
45R02Cd-32-32	2	51	32	145.0	79.4	67	62.0	12.57

订货示例:

碳钢, 无六价铬镀锌: 45R02Cd-08-08

304不锈钢: 45R02Cd-08-08-304

316不锈钢: 45R02Cd-08-08-316

如需用于四层钢丝软管, 订货号改为: 45R04Cd-08-08

90R02Sr 两层胶管接头-24°锥轻系列

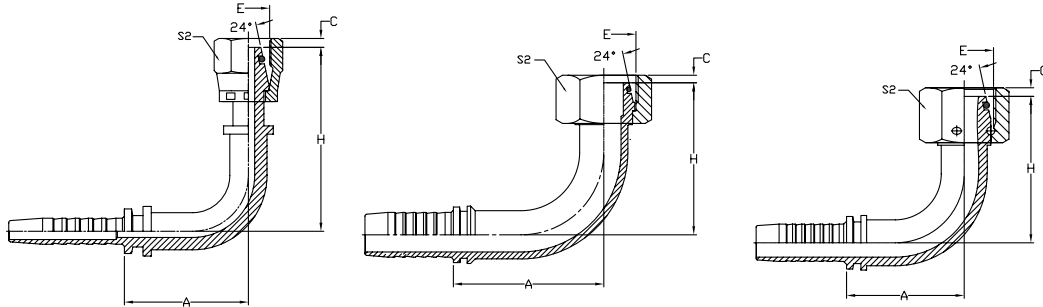

订货号	螺纹E THREAD E	胶管HOSE BORE 公称内径DN 标号DASH	管子外径 TUBE O.D.	O型圈 O RING	尺寸 DIMENSIONS			
					A	C	H	S2
90R02Sr-04-L06	M12x1.5	6 04	6	4.5x1.5	27.0	1.0	30.0	17
90R02Sr-04-L08	M14x1.5	6 04	8	6.5x1.5	28.5	2.0	34.5	19
90R02Sr-04-L10	M16x1.5	6 04	10	8.0x1.5	27.5	2.0	33.0	19
90R02Sr-05-L10	M16x1.5	8 05	10	8.0x1.5	32.0	2.0	36.0	19
90R02Sr-06-L10	M16x1.5	10 06	10	8.0x1.5	30.0	2.0	37.0	22
90R02Sr-05-L12	M18x1.5	8 05	12	10.0x1.5	31.0	1.5	40.0	22
90R02Sr-06-L12	M18x1.5	10 06	12	10.0x1.5	33.0	2.5	48.0	22
90R02Sr-06-L15	M22x1.5	10 06	15	12.0x2.0	32.5	3.0	44.5	27
90R02Sr-08-L15	M22x1.5	13 08	15	12.0x2.0	42.0	2.5	49.0	27
90R02Sr-08-L18	M26x1.5	13 08	18	15.0x2.0	41.0	2.1	50.5	32
90R02Sr-10-L18	M26x1.5	16 10	18	15.0x2.0	53.0	2.5	53.5	32
90R02Sr-12-L18	M26x1.5	19 12	18	15.0x2.0	58.0	2.5	58.0	36
90R02Sr-10-L22	M30x2.0	16 10	22	20.0x2.0	53.0	3.8	59.0	36
90R02Sr-12-L22	M30x2.0	19 12	22	20.0x2.0	61.0	4.0	60.5	36
90R02Sr-12-L28	M36x2.0	19 12	28	26.0x2.0	61.0	4.5	61.0	41
90R02Sr-16-L35	M45x2.0	25 16	35	32.0x2.5	75.7	4.0	73.5	55
90R02Sr-20-L35	M45x2.0	32 20	35	32.0x2.5	91.5	4.0	86.0	55
90R02Sr-20-L42	M52x2.0	32 20	42	38.0x2.5	93.0	4.0	87.0	60
90R02Sr-24-L42	M52x2.0	38 24	42	38.0x2.5	106.5	4.0	98.0	60

订货示例:

碳钢, 无六价铬镀锌: 90R02Sr-04-L06

304不锈钢: 90R02Sr-04-L06-304

316不锈钢: 90R02Sr-04-L06-316

如需用于四层钢丝软管, 订货号改为: 90R04Sr-04-L06

90R02Sr 两层胶管接头-24°锥重系列

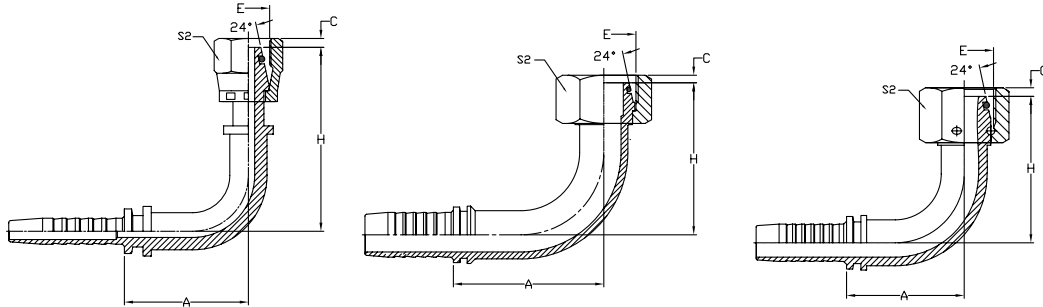

订货号	螺纹E THREAD E	胶管HOSE BORE		管子外径 TUBE O.D.	O型圈 O RING	尺寸 DIMENSIONS			
		公称内径DN	标号DASH			A	C	H	S2
90R02Sr-04-S06	M14x1.5	6	04	6	4.5x1.5	27.3	1.5	33.0	17
90R02Sr-04-S08	M16x1.5	6	04	8	6.5x1.5	27.0	1.5	34.0	19
90R02Sr-05-S08	M16x1.5	8	05	8	6.5x1.5	28.8	1.5	32.0	19
90R02Sr-05-S10	M18x1.5	8	05	10	8.0x1.5	31.0	1.5	36.5	22
90R02Sr-06-S10	M18x1.5	10	06	10	8.0x1.5	32.3	2.0	38.0	22
90R02Sr-06-S12	M20x1.5	10	06	12	10.0x1.5	31.5	2.5	38.5	24
90R02Sr-08-S12	M20x1.5	13	08	12	10.0x1.5	35.0	2.5	41.5	27
90R02Sr-06-S14	M22x1.5	10	06	14	11.0x2.0	35.3	3.0	43.8	27
90R02Sr-08-S14	M22x1.5	13	08	14	11.0x2.0	41.8	2.5	49.0	27
90R02Sr-08-S16	M24x1.5	13	08	16	13.0x2.0	41.0	3.0	50.5	30
90R02Sr-10-S16	M24x1.5	16	10	16	13.0x2.0	43.5	2.5	52.0	30
90R02Sr-10-S20	M30x2.0	16	10	20	16.3x2.4	53.0	2.5	56.5	36
90R02Sr-12-S20	M30x2.0	19	12	20	16.3x2.4	58.0	3.0	56.5	36
90R02Sr-12-S25	M36x2.0	19	12	25	20.3x2.4	61.0	3.2	61.8	46
90R02Sr-16-S30	M42x2.0	25	16	30	25.3x2.4	75.0	3.9	73.6	50
90R02Sr-20-S38	M52x2.0	32	20	38	33.3x2.4	91.0	4.5	86.5	60
90R02Sr-24-S38	M52x2.0	38	24	38	33.3x2.4	106.0	4.5	97.0	60

订货示例:

碳钢, 无六价铬镀锌: 90R02Sr-04-S06

304不锈钢: 90R02Sr-04-S06-304

316不锈钢: 90R02Sr-04-S06-316

如需用于四层钢丝软管, 订货号改为: 90R04Sr-04-S06

90R02Sb 两层胶管接头-BSP 60°锥

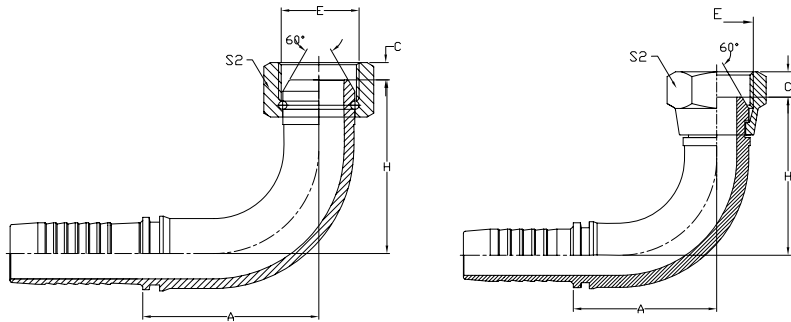

订货号	螺纹E THREAD E	胶管HOSE BORE 公称内径DN 标号DASH		尺寸 DIMENSIONS			
				A	C	H	S2
90R02Sb-04-04	G1/4	6	04	26.9	5.5	33.4	19
90R02Sb-05-04	G1/4	8	05	33.0	5.5	39.5	19
90R02Sb-06-04	G1/4	10	06	30.0	5.5	36.5	19
90R02Sb-04-06	G3/8	6	04	30.0	6.3	35.2	22
90R02Sb-05-06	G3/8	8	05	33.0	6.3	40.7	22
90R02Sb-06-06	G3/8	10	06	35.5	6.3	43.0	22
90R02Sb-06-08	G1/2	10	06	35.3	7.0	45.8	27
90R02Sb-08-08	G1/2	13	08	41.0	7.5	51.0	27
90R02Sb-10-08	G1/2	16	10	56.5	7.5	55.5	27
90R02Sb-08-10	G5/8	13	08	41.0	9.5	51.5	30
90R02Sb-10-10	G5/8	16	10	56.0	9.5	56.0	30
90R02Sb-08-12	G3/4	13	08	41.0	10.9	52.1	32
90R02Sb-10-12	G3/4	16	10	61.0	10.9	60.8	32
90R02Sb-12-12	G3/4	19	12	61.0	10.9	60.8	32
90R02Sb-12-16	G1	19	12	65.5	11.7	68.3	41
90R02Sb-16-16	G1	25	16	75.0	11.7	72.5	41
90R02Sb-16-20	G1 1/4	25	16	78.0	11.0	69.5	50
90R02Sb-20-20	G1 1/4	32	20	91.0	11.0	80.5	50
90R02Sb-24-24	G1 1/2	38	24	106.0	13.0	100.0	55
90R02Sb-32-32	G2	51	32	132.0	16.0	123.3	70

订货示例:

碳钢, 无六价铬镀锌: 90R02Sb-04-04

304不锈钢: 90R02Sb-04-04-304

316不锈钢: 90R02Sb-04-04-316

如需用于四层钢丝软管, 订货号改为: 90R04Sb-04-04

90R02Sj 两层胶管接头-JIC37°锥

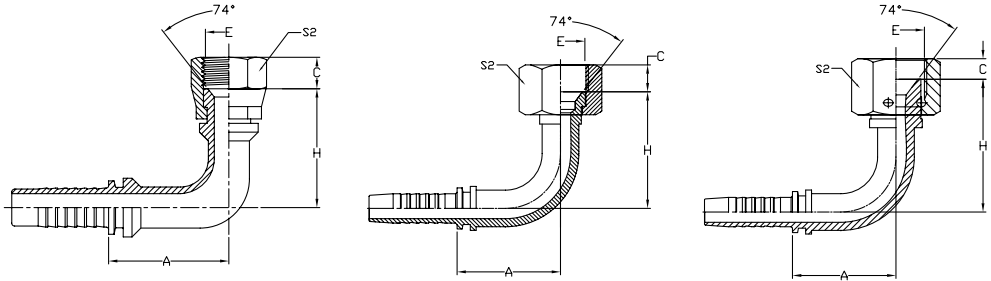

订货号	螺纹E THREAD E	胶管HOSE BORE 公称内径DN 标号DASH		尺寸 DIMENSIONS			
				A	C	H	S2
90R02Sj-04-04	7/16-20	6	04	30.0	9.0	33.5	15
90R02Sj-06-06	9/16-18	10	06	35.3	10.5	39.3	19
90R02Sj-08-06	9/16-18	13	08	41.0	10.5	44.5	19
90R02Sj-06-08	3/4-16	10	06	35.3	11.0	41.3	24
90R02Sj-08-08	3/4-16	13	08	41.0	11.0	47.5	24
90R02Sj-10-08	3/4-16	16	10	53.0	11.0	50.5	24
90R02Sj-08-10	7/8-14	13	08	41.0	13.0	48.0	27
90R02Sj-10-10	7/8-14	16	10	53.0	13.0	51.0	27
90R02Sj-12-10	7/8-14	19	12	64.9	13.0	62.0	27
90R02Sj-08-12	1 1/16-12	13	08	41.0	15.0	49.5	32
90R02Sj-10-12	1 1/16-12	16	10	61.0	15.0	58.0	32
90R02Sj-12-12	1 1/16-12	19	12	61.0	15.0	58.0	32
90R02Sj-12-16	1 5/16-12	19	12	65.5	16.0	63.5	41
90R02Sj-16-16	1 5/16-12	25	16	75.0	16.0	70.0	41
90R02Sj-20-20	1 5/8-12	32	20	91.5	17.0	87.0	50
90R02Sj-20-24	1 7/8-12	32	20	91.5	20.0	97.5	55
90R02Sj-24-24	1 7/8-12	38	24	106.0	20.0	94.0	55
90R02Sj-32-32	2 1/2-12	51	32	132.0	23.5	121.8	75

订货示例:

碳钢, 无六价铬镀锌: 90R02Sj-04-04

304不锈钢: 90R02Sj-04-04-304

316不锈钢: 90R02Sj-04-04-316

如需用于四层钢丝软管, 订货号改为: 90R04Sj-04-04

90R02Cj 两层胶管接头-90°法兰轻系列

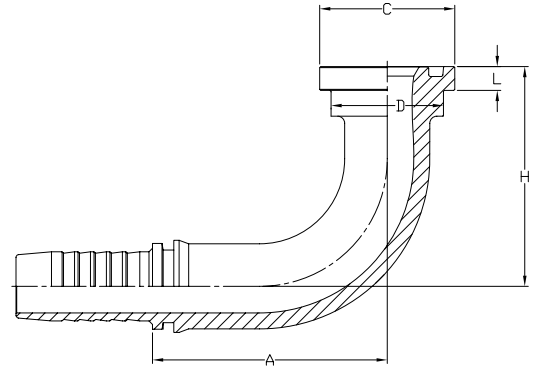

订货号	法兰型号 FLANGE SIZE	胶管HOSE BORE 公称内径DN 标号DASH		尺寸 DIMENSIONS				
				A	C	D	H	L
90R02Cj-08-08	1/2	13	08	41.0	30.2	24.0	47.0	6.73
90R02Cj-08-12	3/4	13	08	41.0	38.1	31.7	48.0	6.73
90R02Cj-10-12	3/4	16	10	56.0	38.1	31.7	52.5	6.73
90R02Cj-12-12	3/4	19	12	61.0	38.1	31.7	56.0	6.73
90R02Cj-16-12	3/4	25	16	75.0	38.1	31.7	66.0	6.73
90R02Cj-12-16	1	19	12	61.0	44.4	38.0	56.0	8.00
90R02Cj-16-16	1	25	16	75.0	44.4	38.0	66.0	8.00
90R02Cj-20-16	1	32	20	91.5	44.4	38.0	78.5	8.00
90R02Cj-16-20	1 1/4	25	16	75.0	50.8	43.0	66.0	8.00
90R02Cj-20-20	1 1/4	32	20	91.0	50.8	43.0	78.5	8.00
90R02Cj-24-20	1 1/4	38	24	97.5	50.8	43.0	78.5	8.00
90R02Cj-20-24	1 1/2	32	20	91.0	60.3	50.0	80.5	8.00
90R02Cj-24-24	1 1/2	38	24	106.0	60.3	50.0	91.0	8.00
90R02Cj-24-32	2	38	24	106.0	71.4	62.0	91.0	9.53
90R02Cj-32-32	2	51	32	132.0	71.4	62.0	114.3	9.53

订货示例:

碳钢, 无六价铬镀锌: 90R02Cj-08-08

304不锈钢: 90R02Cj-08-08-304

316不锈钢: 90R02Cj-08-08-316

如需用于四层钢丝软管, 订货号改为: 90R04Cj-08-08

90R02Cd 两层胶管接头-90°法兰重系列

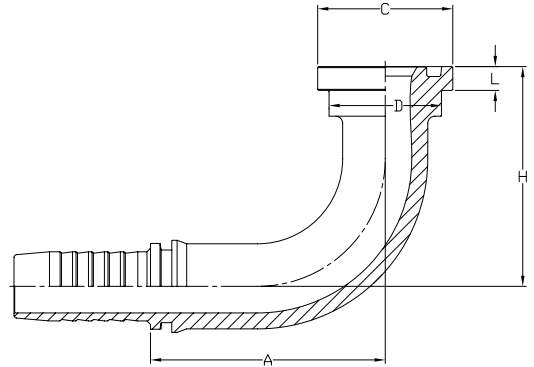

订货号	法兰型号 FLANGE SIZE	胶管HOSE BORE 公称内径DN 标号DASH		尺寸 DIMENSIONS				
				A	C	D	H	L
90R02Cd-08-08	1/2	13	08	41.0	31.7	24	48.0	7.75
90R02Cd-10-12	3/4	16	10	56.0	41.3	32	56.5	8.76
90R02Cd-12-12	3/4	19	12	65.5	41.3	32	66.0	8.76
90R02Cd-12-16	1	19	12	61.0	47.6	38	63.0	9.53
90R02Cd-16-16	1	25	16	75.0	47.6	38	73.0	9.53
90R02Cd-20-16	1	32	20	91.5	47.6	38	85.5	9.53
90R02Cd-16-20	1 1/4	25	16	76.7	54.0	44	78.5	10.29
90R02Cd-20-20	1 1/4	32	20	91.0	54.0	44	89.5	10.29
90R02Cd-20-24	1 1/2	32	20	91.5	63.5	51	94.5	12.57
90R02Cd-24-24	1 1/2	38	24	109.4	63.5	51	108.0	12.57
90R02Cd-24-32	2	38	24	109.4	79.4	67	116.0	12.57
90R02Cd-32-32	2	51	32	132.0	79.4	67	136.3	12.57

订货示例:

碳钢, 无六价铬镀锌: 90R02Cd-08-08

304不锈钢: 90R02Cd-08-08-304

316不锈钢: 90R02Cd-08-08-316

如需用于四层钢丝软管, 订货号改为: 90R04Cd-08-08

KR02套筒-两层套筒

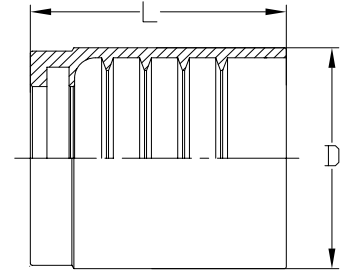

订货号	胶管HOSE BORE		尺寸 DIMENSIONS
	公称内径 DN	标号 DASH	L
KR02-03	5	03	23.0
KR02-04	6	04	30.5
KR02-05	8	05	30.0
KR02-06	10	06	32.0
KR02-08	12	08	34.0
KR02-10	16	10	37.0
KR02-12	19	12	42.0
KR02-16	25	16	51.0

订货示例:

碳钢, 无六价铬镀锌: KR02-03

304不锈钢: KR02-03-304

316不锈钢: KR02-03-316

KR04套筒-四层套筒

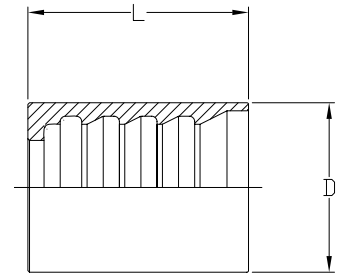

订货号	胶管HOSE BORE		尺寸 DIMENSIONS
	公称内径 DN	标号 DASH	L
KR04-04	6	04	37.5
KR04-06	10	06	39.0
KR04-08	12	08	41.0
KR04-10	16	10	43.0
KR04-12	20	12	51.0
KR04-16	25	16	61.5
KR04-20	32	20	67.5
KR04-24	40	24	75.0
KR04-32	50	32	79.0

订货示例:

碳钢, 无六价铬镀锌: KR04-04

304不锈钢: KR04-04-304

316不锈钢: KR04-04-316

软管总成

1.命名方式

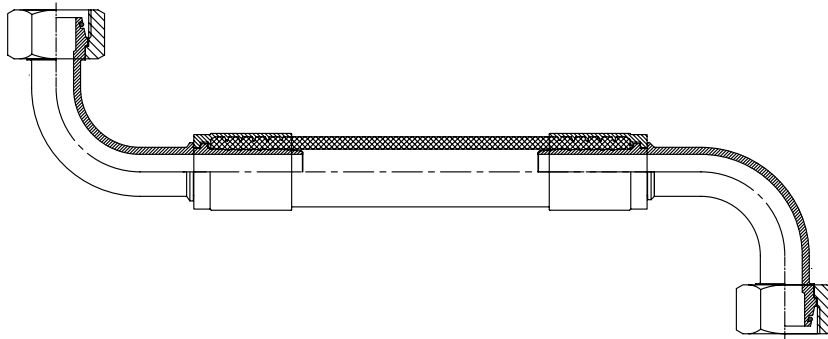

2.长度规范

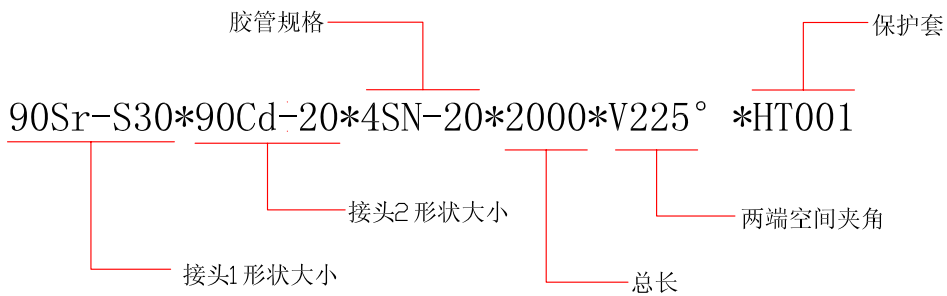

3.空间夹角

空间夹角:两端均为弯接头的软管总成才标注

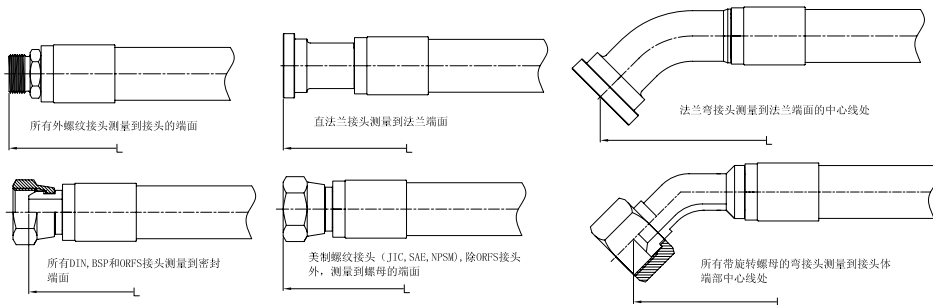

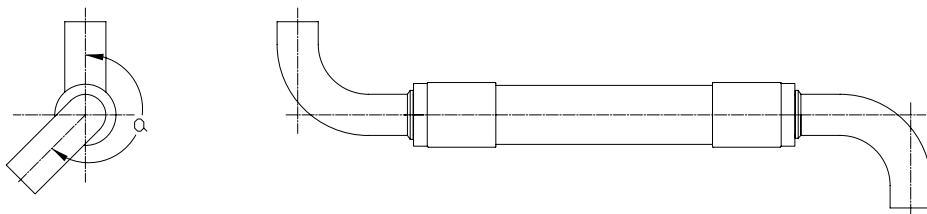

4.护套编号

- HT001: 塑料护套
- HT002: 弹簧护套



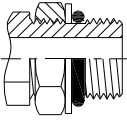
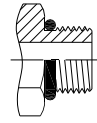
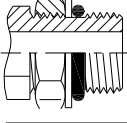
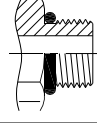
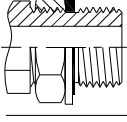
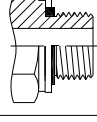
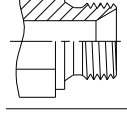
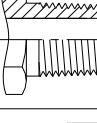
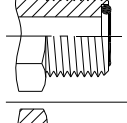
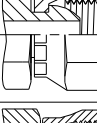
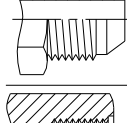
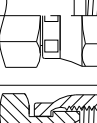
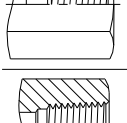
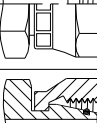
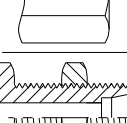
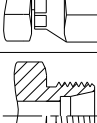
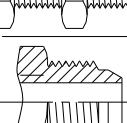
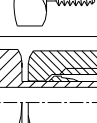
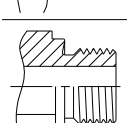
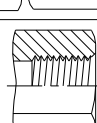
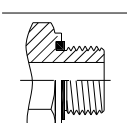
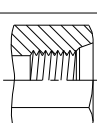

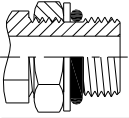
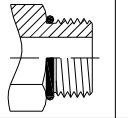
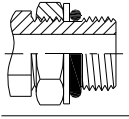
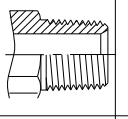
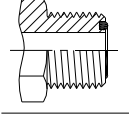
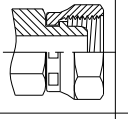
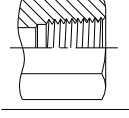
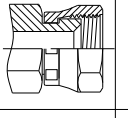
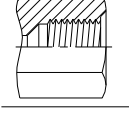
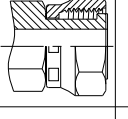
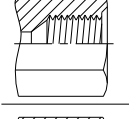
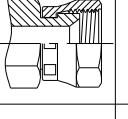
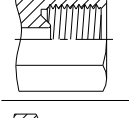
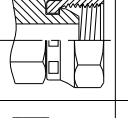
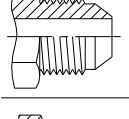
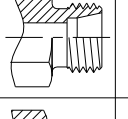
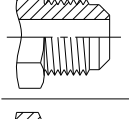
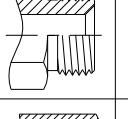
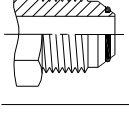
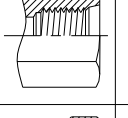
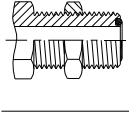
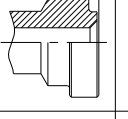
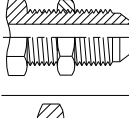
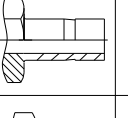
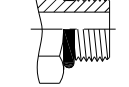
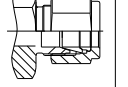

公制螺纹头型示意图、代号、设计标准、螺纹类型及密封方式

	Am	SAE J2244-3 ISO 6149-3	公制外 螺纹	轻系列 可调向油口接头 油口倒角内O型 圈密封		Om	ISO 6149-3 SAE J2244-3	公制外 螺纹	轻系列 油口接头 油口倒角内O型圈 密封
	An	SAE J2244-2 ISO 6149-2	公制外 螺纹	重系列 可调向油口接头 油口倒角内O型 圈密封		On	SAE J2244-2 ISO 6149-2	公制外 螺纹	重系列 油口接头 油口倒角内O型圈 密封
	As	ISO 9974 DIN 3852-1	公制外 螺纹	轻系列 可调向油口接头 组合垫圈 油口平面上密封		Or	ISO 9974 DIN 3852-1	公制外 螺纹	轻系列 油口接头 组合垫圈 油口平面上密封
	Bg	DIN 3863 Type U	公制外 螺纹	60° 内锥面密封		Rm		公制外 锥螺纹	螺纹密封
	Dm	JB/T	公制外 螺纹	O型圈平面密封		Sg	DIN 3863	公制内 螺纹	扣螺帽 外锥/圆弧面密封
	Jm	GB/T	公制外 螺纹	74° 外锥面密封		Sm	GB/T	公制内 螺纹	扣螺帽 74° 内锥面密封
	Hk	Komatsu	公制内 螺纹	小松 60° 内锥面密封		Sk	Komatsu	公制内 螺纹	扣螺帽 60° 内锥面密封
	Hm		公制内 锥螺纹	螺纹密封		Sr	ISO 8434 DIN 3865	公制内 螺纹	扣螺帽 24° 外锥面 O型圈密封
	Kt	ISO 8434 DIN 3865	公制外 螺纹	过板接头 24° 内锥面密封		T	ISO-8434 DIN 3861	公制外 螺纹	24° 内锥面密封
	Ku	Komatsu	公制外 螺纹	小松 60° 外锥面密封		Ts	ISO 8434	公制内 螺纹	管子连接端 同T头配合进行密封
	Lk Lm Ln	ISO-9974-3	公制外 螺纹	特轻系列 轻系列/重系列 油口接头 油口平面上 金属对金属密封		Xf	ISO 9974-1 DIN 3852-1	公制内 螺纹	油口端头 油口平面上密封
	Oe Of	ISO-9974-2	公制外 螺纹	轻系列 重系列 油口接头 根部槽内密封垫 油口平面上密封		Xm	ISO 6149-1 SAE 2244-1 DIN 3852-3	公制内 螺纹	油口端头 油口倒角内密封圈 密封

美标头型示意图、代号、设计标准、螺纹类型及密封方式

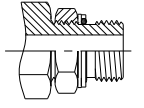
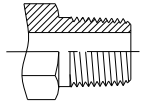
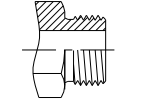
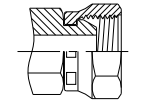
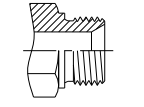
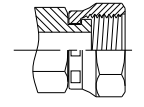
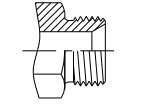
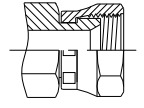
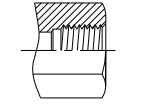
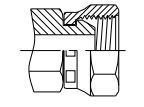
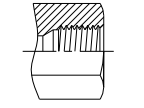
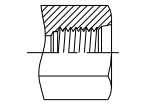
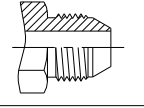
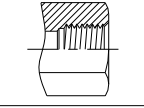
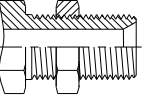
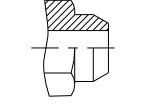
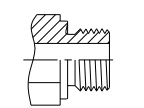
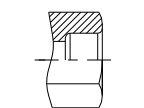
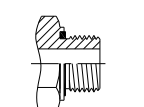
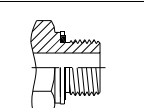
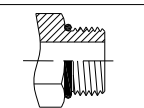
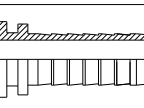
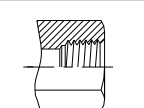
	Ad	SAE J1926-2 ISO 11926-2	美制UN 外螺纹	重系列 可调向油口接头 油口倒角内O型 圈密封		Oj	SAE J1926-3 ISO 11926-3	美制UN 外螺纹	轻系列 油口接头 油口倒角内O型圈 密封
	Aj	SAE J1926-3 ISO 11926-3	美制UN 外螺纹	轻系列 可调向油口接头 油口倒角内O型 圈密封		P	SAE J514	美制NPTF 外锥螺纹	螺纹密封或口部60° 内锥面密封
	D	SAE J1453	美制UN 外螺纹	O型圈 平面密封		Sa	SAE J514	美制UN 内螺纹	扣螺帽 圆弧面密封 (同Ta头型相配合)
	G	SAE J514	美制NPTF 内锥螺纹	螺纹密封		Sc	SAE J512 SAE J513	美制UN 内螺纹	扣螺帽 45°内锥面密封
	Hc	SAE J512 SAE J513	美制UN 内螺纹	45°内锥面密封		Sd	SAE J1453 ISO 8434	美制UN 内螺纹	扣螺帽 内平面密封
	Hj	SAE J514	美制UN 内螺纹	74°内锥面密封		Sj	SAE J514 ISO 8434	美制UN 内螺纹	扣螺帽 74°内锥面密封
	Hv	SAE J512 SAE J513	美制UN 内螺纹	45°外锥面密封		Sp	SAE J514	美制NPSM 内螺纹	扣螺帽 60°外锥面密封
	J	SAE J514 ISO 8434	美制UN 外螺纹	74°外锥面密封		Ta	SAE J514	美制UN 外螺纹	24°内锥面密封
	Jc	SAE J512 SAE J513	美制UN 外螺纹	45°外锥面密封		Bv	SAE J512 SAE J513	美制UN 外螺纹	45°内锥面密封
	Jg	SAE J514	美制UN 外螺纹	74°外锥面 O形圈密封		X	ISO11926-1 SAE J1926-1	美制UN 内螺纹	油口端头 油口倒角内O型圈密封
	Kd	SAE J1453	美制UN 外螺纹	过板接头 O型圈平面密封		Cj Cd	SAE J518		美制法兰接头 轻系列/重系列 Code 61/Code 62
	Kj	SAE J514	美制UN 外螺纹	过板接头 74°外锥面密封		Ns			双卡套管体端
	Od	SAE J1926-2 ISO 11926-2	美制UN 外螺纹	重系列 油口接头 油口倒角内O型圈 密封		N			双卡套管管端

英制螺纹头型、焊接头型、高压胶管接头头型 示意图、代号、设计标准、螺纹类型及密封方式

	Ab	ISO-1179-3	英制BSPP 外螺纹	轻系列 可调向油口接头 组合垫圈 油口平面上密封		R		英制BSPT 外锥螺纹	螺纹密封		
	B		英制BSPP 外螺纹	端面平面密封		Sb	BS5200	英制BSPP 内螺纹	扣螺帽 60° 外锥面密封		
	Bc	BS5200	英制BSPP 外螺纹	60° 内锥面密封 或根部装组合垫圈 油口平面上密封		Sb -P		英制BSPP 内螺纹	扣螺帽 内平面密封		
	Bn	JIS B8363	英制BSPP 外螺纹	60° 内锥面密封		Se	JIS B8363	英制BSPP 内螺纹	扣螺帽 60° 内锥面密封		
	H		英制BSPP 内螺纹	配合BSPT 螺纹密封		Sn	JIS B8363	英制BSPP 内螺纹	扣螺帽 60° 外锥面密封		
	Ht	JIS B8363	英制BSPP 内螺纹	60° 内锥面密封		Xb	BS5380	英制BSPP 内螺纹	油口端头 倒角内O型圈密封		
	Jt	JIS B8363	英制BSPP 外螺纹	60° 外锥面密封		Xg	ISO 1179-1 DIN 3852-2	英制BSPP 内螺纹	油口端头 油口平面上密封		
	Kb	BS5200	英制BSPP 外螺纹	过板接头 60° 内锥面密封		Wb			焊管端头		
	La	ISO-9974-4	英制BSPP 外螺纹	特轻系列 轻系列、重系列 油口接头 油口平面上 金属对金属密封		Wg			钎焊端头		
	Lb										
	Lc										
	Og	ISO-1179-2	英制BSPP 外螺纹	轻系列 重系列 油口接头 根部槽内密封垫 油口平面上密封		Wp			焊管端头		
	Oh	ISO-8434	英制BSPP 外螺纹								
	Os	ISO-1179-3	英制BSPP 外螺纹	轻系列 油口接头 组合垫圈 油口平面上密封		Wt			焊管端头		
	Ot	JIS-B2351 Type "O"	英制BSPP 外螺纹	油口接头 油口倒角内O型圈 密封		R02			扣压式普通 高压胶管接头		
	Q		英制BSPT 内锥螺纹	螺纹密封		R04			内锁式高压 胶管接头		

头型规格速查表

美标UN/UNF/UNS螺纹系列产品头型规格						
规格	硬管外径 (英寸)	硬管外径 (毫米mm)	D, Sd, Kd 头型连接螺纹规格	Ad, Aj, J, Jg, Kj, Ka, Od, Oj, Sa, Sj, Ta, X 头型连接螺纹规格	Hc, Jc, Sc 头型连接螺纹规格	Hv, Bv 头型连接 螺纹规格
-02	1/8			5/16-24 UNF	5/16-24 UNF	5/16-28 UN
-03	3/16			3/8-24 UNF	3/8-24 UNF	3/8-24 UNF
-04	1/4	6	9/16-18 UNF	7/16-20 UNF	7/16-20 UNF	7/16-24 UNS
-05	5/16	8	5/8-18 UNF	1/2-20 UNF	1/2-20 UNF	1/2-20 UNF
-06	3/8	10	11/16-16 UN	9/16-18 UNF	5/8-18 UNF	5/8-18 UNF
-07	7/16				11/16-16 UN	11/16-18 UNS
-08	1/2	12	13/16-16 UN	3/4-16 UNF	3/4-16 UNF	3/4-18 UNS
-10	5/8	16	1-14 UNS	7/8-14 UNF	7/8-14 UNF	7/8-18 UNS
-12	3/4	20	1-3/16-12 UN	1-1/16-12 UN	1-1/16-14 UNS	1-1/16-16 UN
-14	7/8	22	1-5/16-12 UN	1-3/16-12 UN	1-1/4-12 UNF	
-16	1	25	1-7/16-12 UN	1-5/16-12 UN	1-3/8-12 UNF	
-20	1-1/4	30	1-11/16-12 UN	1-5/8-12 UN		
-24	1-1/2	38	2-12 UN	1-7/8-12 UN		
-32	2	50		2-1/2-12 UN		

规格	G, P, S, Sp 头型连接螺纹规格 (NPTF/NPSM)	所有连接螺纹为 BSPP, BSPT 头型
-02	1/8-27	1/8-28
-04	1/4-18	1/4-19
-06	3/8-18	3/8-19
-08	1/2-14	1/2-14
-10		5/8-14
-12	3/4-14	3/4-14
-16	1-11.5	1-11
-20	1-1/4-11.5	1-1/4-11
-24	1-1/2-11.5	1-1/2-11
-32	2-11.5	2-11

公制卡套式接头头型规格			
规格	硬管外径 (毫米mm)	K1, Sr, T, Ts 头型连接螺纹规格	卡套螺母六角
-LL04	4	M8 x 1	10
-LL05	5	M10 x 1	12
-LL06	6	M10 x 1	12
-LL08	8	M12 x 1	14
-L06	6	M12 x 1.5	14
-L08	8	M14 x 1.5	17
-L10	10	M16 x 1.5	19
-L12	12	M18 x 1.5	22
-L15	15	M22 x 1.5	27
-L18	18	M26 x 1.5	32
-L22	22	M30 x 2	36
-L28	28	M36 x 2	41
-L35	35	M45 x 2	50
-L42	42	M52 x 2	60
-S06	6	M14 x 1.5	17
-S08	8	M16 x 1.5	19
-S10	10	M18 x 1.5	22
-S12	12	M20 x 1.5	24
-S16	16	M24 x 1.5	30
-S20	20	M30 x 2	36
-S25	25	M36 x 2	46
-S30	30	M42 x 2	50
-S38	38	M52 x 2	60

其它应用公制螺纹的头型:

规格大小代号与其连接螺纹大小相同
 如: ISO6149-3轻系列油口接头Om,
 若螺纹为M08x1, 则此头型代号及规格为
 Om-M08

BIS产品命名示例

形状描述	
描述	表述意思
00	直通接头
45	45度弯头
90	90度弯头
TSrT	3个大写字母表示三通
TTTT	4个大写字母表示三通

头型描述	
描述	表述意思
T	表示24度锥密封头型, 详见113-115
S08	表示24度锥重型卡8mm头型, 见116

直通接头

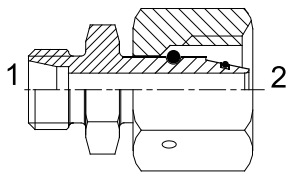

第一端头型代号及规格

00TSr-S08-S08

直通

第二端头型
代号及规格

45°弯头

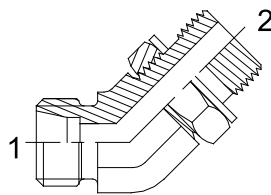

第一端头型代号及规格

45TA_b-L08-08

45°弯头

第二端头型
代号及规格

90°弯头

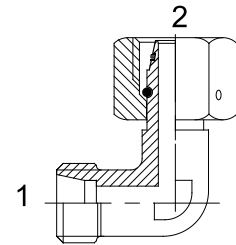

第一端头型代号及规格

90TSr-S08-S08

90°弯头

第二端头型
代号及规格

三通接头

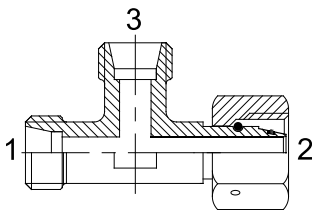

第一端头型代号及规格

TSrT-S08-S08-S08

第二端头型
代号及规格

第三端头型
代号及规格

四通接头

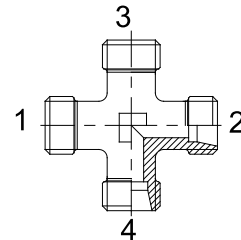

第一端头型代号及规格

TTTT-L08-L08-L08-L08

第二端头型
代号及规格

第三端头型
代号及规格

头型代号及密封式速查表

螺纹类型		美制UN/UNF螺纹				英制BSPP螺纹				公制 (Metric) 螺纹				
头型标准		SAE J514	SAE J1453	SAE J512	NPTF	NPSM	BSPT	JIS B 8363	BS5200	DIN 3861 DIN 3865 ISO 8434 DIN 2353 GB/T JB/T	DIN 3863			Komatsu
密封面角度		ISO 8434-2		SAE J513	SAE J514	SAE J514				Jm				Ku
密封形式		ISO 8434-3		SAE J512	SAE J514	SAE J514				Sm				Sk
外螺纹带外锥面密封	30° (60°) 37° (74°) 45°	J/Jg	Jc					Jt						
扣帽内带内锥面密封	30° (60°) 37° (74°) 45°	Sj	Sc					Se						
外螺纹带内锥面密封	24° 30° (60°) 45°	Ta			P/Ps		Rc	Bn	Bc	T	Bt	Bg		
扣帽内带外锥密封	24° 30° (60°) 45°	Sa		Bv		Sp		Sn	Sb	Sr	Sg			
内螺纹带外锥密封	45°		Hv											
内螺纹带内锥密封	30° (60°) 37° (74°) 45°	Hj	Hc					Ht						Hk
外螺纹带内锥密封					P	R				Rm				
内螺纹带内锥密封					G	Q			H	Hm				
外螺纹前端带平面密封		D							B	Dim				
扣帽内带平面密封		Sd							Sb-P					
说明	Jg头型在37°锥面上带O形圈密封,其它尺寸同J头型完全相同	空调系统及汽车用管接头	Ps指可旋转的带外NPTF锥螺纹的连接头型	H头型需同R头型相配合以形成密封。B和Sb-P为BSPF螺纹的平面密封形式	Sr头型锥面上带密封圈,不带密封圈时须特别注明	设计参照德标DIN 3863 类型 (Type) Y, 口部60°内锥面后带一个台阶	设计参照德标DIN 3863 类型 (Type) U, 口部60°内锥面后无台阶	Komatau (小松) 设计						

其它头型：Cj：SAE J518 Code 61轻系列法兰连接头型 Cd：SAE J518 Code 61重系列法兰连接头型 K：隔版接头，下标为对应的接头样式 W：焊接接头形式，据不同情况加下标编码

US DISTRIBUTION CENTERS

ATLANTA TOLL FREE: 800.458.1988
FAX: 770.987.0926

CLEVELAND TOLL FREE: 800.331.1523
FAX: 440.248.9375

DALLAS TOLL FREE: 800.443.9937
FAX: 972.660.6638

HOUSTON TOLL FREE: 800.443.9937
FAX: 713.808.9477

LOS ANGELES TOLL FREE: 800.942.5321
FAX: 949.595.0933

SEATTLE TOLL FREE: 800.445.7107
FAX: 253.826.4884

INT' L DISTRIBUTION CENTERS

BIRMINGHAM, UK PHONE: 01922 650039
FAX: 01922 626179

SHANGHAI, CN PHONE: +86 21 57391155
FAX: 86 21 57390688

CANADIAN DISTRIBUTION CENTERS

CALGARY TOLL FREE: 844.379.9300
FAX: 403.279.4583

MONTREAL PHONE: 514.339.1139
FAX: 514.339.2601

TORONTO TOLL FREE: 855.267.9013
FAX: 905.673.8788

VANCOUVER PHONE: 604.420.6540
FAX: 604.420.6545

WINNIPEG PHONE: 204.694.8068
FAX: 204.694.8113



CORPORATE HEADQUARTERS

6701 Cochran Road
Solon, Ohio 44139 USA

DOMESTIC MANUFACTURING FACILITY

26420 Century Corners Parkway
Cleveland, Ohio 44132 USA

PHONE: 440.248.1880

TOLL FREE: 888.331.1523

FAX: 440.248.7282

中国 销售中心

地址: 上海市金山区廊下镇新风路2号
编码: 201516

电话: 18516153374 13917784792
13918752669 15001999506

传真: 021-57390688

网址: WWW.BRENNANCHINA.COM

brennaninc.com

