

FEDERTEC
to the best, together

REPERTORIO *DIRECTORY* 2024 | 2025

H-01 POMPE

- H-01.1 Pompe ad ingranaggi
- H-01.2 Pompe a palette
- H-01.3 Pompe a pistoni assiali
- H-01.4 Pompe a pistoni radiali
- H-01.5 Pompe a mano
- H-01.10 Altre pompe

H-02 MOTORI

- H-02.1 Motori ad ingranaggi
- H-02.2 Motori a palette
- H-02.3 Motori a pistoni assiali
- H-02.4 Motori a pistoni radiali
- H-02.5 Motori orbitali
- H-02.10 Altri motori

H-03 CILINDRI

- H-03.1 Cilindri a semplice e doppio effetto
- H-03.2 Cilindri telescopici
- H-03.3 Attuatori angolari
- H-03.4 Argani idraulici
- H-03.5 Accessori per cilindri (fissaggi, sensori)
- H-03.10 Altri cilindri e attuatori

H-04 VALVOLE

- H-04.1 Valvole di controllo direzionale
- H-04.2 Servovalvole e valvole proporzionali
- H-04.3 Valvole di regolazione della pressione
- H-04.4 Valvole a cartuccia
- H-04.10 Altre valvole

H-05 APPARECCHIATURE VARIE

- H-05.1 Accumulatori
- H-05.2 Filtri olio idraulici
- H-05.3 Scambiatori di calore
- H-05.10 Altre apparecchiature

H-06 ACCESSORI IMPIANTO

- H-06.1 Tubi flessibili
- H-06.2 Tubi rigidi
- H-06.3 Raccordi
- H-06.4 Tubi raccordati
- H-06.5 Serbatoi
- H-06.6 Accoppiamenti per alberi rotanti (giunti e lanterne)
- H-06.7 Innesti rapidi
- H-06.8 Flange
- H-06.10 Altri accessori impianto

H-07 SISTEMI

- H-07.1 Centraline ed installazioni complete
- H-07.2 Servosistemi di posizione e velocità
- H-07.3 Pannelli e blocchi collettori
- H-07.10 Altri sistemi

H-09 PARTI E COMPONENTI

- H-09.1 Elettromagneti
- H-09.2 Connettori elettrici
- H-09.3 Guarnizioni
- H-09.4 Tubi levigati
- H-09.5 Barre cromate
- H-09.10 Altre parti e componenti

H-10 STRUMENTAZIONE

- H-10.1 Manometri, pressostati
- H-10.2 Termometri, termostati
- H-10.3 Misuratori di livello
- H-10.4 Trasduttori
- H-10.5 Misuratori di portata
- H-10.10 Altra strumentazione

H-11 FLUIDI IDRAULICI**H-01 PUMPS**

- H-01.1 Gear Pumps
- H-01.2 Vane Pumps
- H-01.3 Axial Piston Pumps
- H-01.4 Radial Piston Pumps
- H-01.5 Hand Pumps
- H-01.10 Others

H-02 MOTORS

- H-02.1 Gear Motors
- H-02.2 Vane Motors
- H-02.3 Axial Piston Motors
- H-02.4 Radial Piston Motors
- H-02.5 Orbital Motors
- H-02.10 Others

H-03 CYLINDERS AND ACTUATORS

- H-03.1 Single- and Double-Acting Cylinders
- H-03.2 Telescopic Cylinders
- H-03.3 Angular Actuators
- H-03.4 Hydraulic Winches
- H-03.5 Accessories for Cylinders (Mounting Devices, Sensors)
- H-03.10 Others

H-04 VALVES

- H-04.1 Directional Control Valves
- H-04.2 Servo-Valves and Proportional Valves
- H-04.3 Pressure Control Valves
- H-04.4 Cartridge Valves
- H-04.10 Others

H-05 VARIOUS EQUIPMENT

- H-05.1 Accumulators
- H-05.2 Hydraulic Filters
- H-05.3 Heat Exchangers
- H-05.10 Others

H-06 CIRCUIT ACCESSORIES

- H-06.1 Hoses
- H-06.2 Tubes
- H-06.3 Connectors (Fittings)
- H-06.4 Hoses with Mounted Fittings
- H-06.5 Reservoirs
- H-06.6 Drive Shaft Couplings (Joints, Bell Housings)
- H-06.7 Quick-Action Couplings
- H-06.8 Flanges
- H-06.10 Others

H-07 SYSTEMS

- H-07.1 Powerpacks and Complete Installations
- H-07.2 Servosystems for Speed and Positioning Control
- H-07.3 Panels and Manifolds Blocks
- H-07.10 Others

H-09 PARTS AND COMPONENTS

- H-09.1 Solenoids
- H-09.2 Electric Connectors
- H-09.3 Seals
- H-09.4 Honed Tubes
- H-09.5 Chromium Plated Bars
- H-09.10 Others

H-10 MEASURING INSTRUMENTATION

- H-10.1 Pressure Gauges, Pressure Switches
- H-10.2 Thermometers, Thermostats
- H-10.3 Level Gauges
- H-10.4 Transducers
- H-10.5 Flowmeters
- H-10.10 Others

H-11 HYDRAULIC FLUIDS

P-03 CILINDRI

- P-03.1 Cilindri con stelo
- P-03.2 Cilindri senza stelo
- P-03.3 Attuatori vari (rotativi, a membrana, pinze, pneumo-idraulici, ecc.)
- P-03.4 Accessori per cilindri (fissaggi, sensori)
- P-03.10 Altri cilindri

P-04 VALVOLE

- P-04.1 Valvole ed elettrovalvole ON/OFF
- P-04.2 Elettrovalvole proporzionali
- P-04.3 Valvole ausiliarie (componenti logici, valvole regolatrici di flusso, valvole a funzione)
- P-04.4 Accessori per valvole ed elettrovalvole (sottobasi, silenziatori, regolatori di scarico)
- P-04.10 Altre valvole

P-05 APPARECCHIATURE VARIE

- P-05.1 Motori pneumatici
- P-05.2 Moltiplicatori di pressione
- P-05.3 Deceleratori
- P-05.10 Altre apparecchiature

P-06 ACCESSORI IMPIANTO

- P-06.1 Tubi flessibili
- P-06.2 Tubi rigidi
- P-06.3 Raccordi
- P-06.4 Giunti rotanti e ripartitori
- P-06.5 Serbatoi
- P-06.6 Innesti rapidi
- P-06.10 Altri accessori

P-08 APPARECCHI TRATTAMENTO ARIA

- P-08.1 Filtri
- P-08.2 Riduttori di pressione
- P-08.3 Filtri-Riduttori di pressione
- P-08.4 Lubrificatori
- P-08.10 Altri apparecchi trattamento aria

P-09 PARTI E COMPONENTI

- P-09.1 Elettromagneti
- P-09.2 Connettori elettrici
- P-09.3 Guarnizioni
- P-09.4 Tubi levigati
- P-09.5 Barre cromate
- P-09.10 Altre parti e componenti

P-10 STRUMENTAZIONE

- P-10.1 Manometri, pressostati
- P-10.2 Termometri, termostati
- P-10.3 Misuratori di livello
- P-10.4 Trasduttori
- P-10.5 Flussometri
- P-10.10 Altra strumentazione

P-12 COMPONENTI PER IL VUOTO**P-13 APPARECCHIATURE LUBRIFICAZIONE CENTRALIZZATA****P-03 CYLINDERS**

- P-03.1 Rod Cylinders
- P-03.2 Rodless Cylinders
- P-03.3 Various Actuators (Rotary, Diaphragm, Grippers, Air-Hydraulic, Etc.)
- P-03.4 Accessories for Cylinders (Mounting Devices, Sensors)
- P-03.10 Others

P-04 VALVES

- P-04.1 On/Off Valves and Solenoid Valves
- P-04.2 Servo-Proportional Valves
- P-04.3 Auxiliary Valves (Logic Components, Flow Regulators, Function Valves)
- P-04.4 Accessories for Valves and Solenoid Valves (Subbases, Silencers, Exhaust Regulators)
- P-04.10 Others

P-05 VARIOUS EQUIPMENT

- P-05.1 Air Motors
- P-05.2 Pressure Intensifiers
- P-05.3 Decelerators
- P-05.10 Others

P-06 CIRCUIT ACCESSORIES

- P-06.1 Hoses
- P-06.2 Tubes
- P-06.3 Connectors (Fittings)
- P-06.4 Rotary Joints and Distribution Frames
- P-06.5 Receivers
- P-06.6 Quick-Action Couplings
- P-06.10 Others

P-08 AIR CONDITIONING UNITS

- P-08.1 Filters
- P-08.2 Pressure Regulators
- P-08.3 Filters-Pressure Regulators
- P-08.4 Lubricators
- P-08.10 Others

P-09 PARTS AND COMPONENTS

- P-09.1 Solenoids
- P-09.2 Electric Connectors
- P-09.3 Seals
- P-09.4 Honed Tubes
- P-09.5 Chromium Plated Bars
- P-09.10 Others

P-10 MEASURING INSTRUMENTATION

- P-10.1 Pressure Gauges, Pressure Switches
- P-10.2 Thermometers, Thermostats
- P-10.3 Level Gauges
- P-10.4 Transducers
- P-10.5 Flowmeters
- P-10.10 Others

P-12 VACUUM COMPONENTS**P-13 CENTRALIZED LUBRICATION EQUIPMENT**

M-01 INGRANAGGI

- M-01.1 Ingranaggi cilindrici
- M-01.2 Ingranaggi conici
- M-01.3 Coppie corona a vite senza fine
- M-01.4 Cremagliere
- M-01.5 Pignoni e ruote catena
- M-01.6 Alberi scanalati
- M-01.7 Altri

M-02 TRASMISSIONI MECCANICHE

- M-02.1 Trasmissioni meccaniche stazionarie
 - M-02.1.1 Riduttori e motoriduttori coassiali
 - M-02.1.2 Riduttori e motoriduttori ad assi paralleli
 - M-02.1.3 Riduttori e motoriduttori ad assi ortogonali
 - M-02.1.4 Riduttori e motoriduttori a vite senza fine
 - M-02.1.5 Riduttori e motoriduttori pendolari
 - M-02.1.6 Riduttori e motoriduttori epicicloidal
 - M-02.1.7 Riduttori di grandi potenza
 - M-02.1.8 Riduttori a gioco ridotto
 - M-02.1.9 Riduttori con cambio di velocità
 - M-02.1.10 Riduttori speciali
 - M-02.1.11 Moltiplicatori
 - M-02.1.12 Mototamburi
 - M-02.1.13 Altri
- M-02.2 Trasmissioni meccaniche per veicoli
 - M-02.2.1 Trasmissioni per macchine agricole
 - M-02.2.2 Trasmissioni per macchine movimento terra
 - M-02.2.3 Trasmissioni marine
 - M-02.2.4 Trasmissioni ferroviarie
 - M-02.2.5 Trasmissioni per automobili
 - M-02.2.6 Trasmissioni per camion e bus
 - M-02.2.7 Trasmissioni per altri veicoli
- M-02.3 Trasmissioni con variazione continua velocità
 - M-02.3.1 Variatori e motorivariatori meccanici
 - M-02.3.2 Variatori idraulici
 - M-02.3.3 Variatori a pulegge variabili (a cinghia)
 - M-02.3.4 Altri
- M-02.4 Gruppi di comando meccanici
 - M-02.4.1 Apparecchiature a camme
 - M-02.4.2 Altri

M-03 ELEMENTI DI TRASMISSIONE

- M-03.1 Giunti e frizioni
 - M-03.1.1 Giunti rigidi e torsionali
 - M-03.1.2 Giunti elastici
 - M-03.1.3 Frizioni ad attrito
 - M-03.1.4 Frizioni elettromagnetiche
 - M-03.1.5 Giunti centrifughi
 - M-03.1.6 Giunti a denti
 - M-03.1.7 Ruote libere
 - M-03.1.8 Limitatori di coppia
 - M-03.1.9 Giunti idraulici
 - M-03.1.10 Giunti a magneti permanenti
 - M-03.1.11 Giunti a snodo
 - M-03.1.12 Allunghe
 - M-03.1.13 Dischi per frizione
 - M-03.1.14 Calettatori
 - M-03.1.15 Shrink disk
 - M-03.1.16 Altri
- M-03.2 Freni
 - M-03.2.1 Freni meccanici
 - M-03.2.2 Freni elettrici
 - M-03.2.3 Freni idraulici
- M-03.3 Alberi
 - M-03.3.1 Alberi cardanici
 - M-03.3.2 Alberi profilati
- M-03.4 Pulegge
 - M-03.4.1 Pulegge a gola
 - M-03.4.2 Pulegge piane
 - M-03.4.3 Pulegge dentate
 - M-03.4.4 Altre
- M-03.5 Cinghie
 - M-03.5.1 Cinghie tangenziali
 - M-03.5.2 Cinghie piane
 - M-03.5.3 Cinghie dentate
 - M-03.5.4 Altre
- M-03.6 Catene industriali
 - M-03.6.1 Catene di trasmissione
 - M-03.6.2 Catene di trasporto
 - M-03.6.3 Altre
- M-04 CUSCINETTI**
 - M-04.1 Cuscinetti a sfera
 - M-04.1.1 Cuscinetti a sfere contatto obliquo ad una corona
 - M-04.1.2 Cuscinetti a sfere a due corone
 - M-04.1.3 Cuscinetti a sfere a contatto obliquo a due corone
 - M-04.1.4 Cuscinetti assiali a sfere e gabbie
 - M-04.1.5 Perni folli e rotelle a sfere
 - M-04.1.6 Ralle di rotazione
 - M-04.1.7 Cuscinetti con anello a sezione sottile

- M-04.1.8 Cuscinetti orientabili
- M-04.1.9 Cuscinetti a sfere in miniatura
- M-04.1.10 Cuscinetti speciali a sfere (generici, automotive, tessile, macchine utensili)
- M-04.2 Cuscinetti a sfere di precisione
 - M-04.2.1 Cuscinetti a sfera di precisione per mandrini
 - M-04.2.2 Supporti per viti
- M-04.3 Cuscinetti a rulli cilindrici
 - M-04.3.1 Cuscinetti assiali a rulli cilindrici
 - M-04.3.2 Cuscinetti a rulli cilindrici con gabbia
 - M-04.3.3 Cuscinetti a rulli cilindrici speciali
- M-04.3.4 Perni folli e rotelle a rulli cilindrici
- M-04.3.5 Cuscinetti a rulli cilindrici a pieno riempimento
- M-04.3.6 Gabbie assiali a rulli cilindrici
- M-04.3.7 Ralle di rotazione
- M-04.3.8 Supporti per viti
- M-04.4 Cuscinetti a rulli conici
- M-04.5 Cuscinetti a rulli a botte
 - M-04.5.1 Cuscinetti oscillanti con rulli a botte
 - M-04.5.2 Gabbie assiali con rulli a botte
- M-04.6 Cuscinetti a rullini
 - M-04.6.1 Cuscinetti assiali a rullini
 - M-04.6.2 Cuscinetti combinati
 - M-04.6.3 Cuscinetti a rullini ad asportazione di trucioli
 - M-04.6.4 Cuscinetti a rullini stampati
 - M-04.6.5 Cuscinetti a rullini stampati a pieno riempimento
 - M-04.6.6 Gabbie radiali a rullini
 - M-04.6.7 Gabbie assiali a rullini
 - M-04.6.8 Perni folli e rotelle a rullini
 - M-04.6.9 Ralle di rotazione
 - M-04.6.10 Supporti per viti
- M-04.7 Unità di supporto complete di cuscinetto
- M-04.7.1 Unità di supporto in lamiera
- M-04.7.2 Unità di supporto in plastica - gomma
- M-04.7.3 Unità di supporto in ghisa
- M-04.8 Corpi volventi (sfere, rulli, rullini)
- M-04.9 Cuscinetti a strisciamento
 - M-04.9.1 Cuscinetti autolubrificanti plastici
 - M-04.9.2 Cuscinetti autolubrificanti metallo polimero

- M-04.9.3 Cuscinetti autolubrificanti bimetallici
- M-04.9.4 Cuscinetti autolubrificanti integrali
- M-04.10 Snodi e teste snodo (strisciamento - volventi)

M-05 SISTEMI LINEARI

- M-05.1 Cuscinetti per movimenti lineari e alberi
 - M-05.1.1 Cuscinetti lineari a strisciamento
 - M-05.1.2 Cuscinetti lineari a sfere (manicotti)
 - M-05.1.3 Supporto alberi
 - M-05.1.4 Alberi per movimenti lineari
- M-05.2 Guide lineari a sfere
 - M-05.2.1 Unità a ricircolazione, a due ranghi
 - M-05.2.2 Pattini/guide a ricircolazione di sfere
 - M-05.2.3 Unità in miniatura a ricircolazione
 - M-05.2.4 Unità a ricircolazione a 6 ranghi
 - M-05.2.5 Unità a ricircolazione a 4 ranghi
 - M-05.2.6 Guide telescopiche a sfere
 - M-05.2.7 Guide piane a sfere
- M-05.3 Guide lineari a ricircolazione rulli
 - M-05.4 Guide a rotelle (acciaio - alluminio - rivestite)
- M-05.5 Guide piane
 - M-05.6 Moduli lineari con comando a cinghia dentata
 - M-05.7 Moduli lineari con comando a vite a ricircolo
 - M-05.8 Moduli lineari con comando a cremagliera
 - M-05.9 Moduli lineari con comando a motore lineare
 - M-05.10 Moduli lineari con comando pneumatico
 - M-05.11 Elettrocilindri/attuatori elettromagnetici
 - M-05.12 Martinetti a vite
 - M-05.13 Tavole di precisione
 - M-05.14 Viti a ricircolo rettificata
 - M-05.14.1 Viti a rulli satelliti
 - M-05.14.2 Viti ad anelli volventi
 - M-05.14.3 Viti a ricircolazione a sfere "rettificate"
 - M-05.15 Viti a ricircolazione di sfere "rullate"

M-01 GEARS

- M-01.1 Cylindrical Gears
- M-01.2 Bevel Gears
- M-01.3 Worm Wheels
- M-01.4 Racks
- M-01.5 Chain Wheels
- M-01.6 Splined Shafts
- M-01.7 Other Gears

M-02 MECHANICAL TRANSMISSIONS

- M-02.1 Mechanical Transmission for Stationary Applications
 - M-02.1.1 In-Line Gear Units and Gearmotors
 - M-02.1.2 Spur Gear Units and Gearmotors
 - M-02.1.3 Bevel and Bevel/Spur Gear Units and Gearmotors
 - M-02.1.4 Worm Gear Units and Gearmotors
 - M-02.1.5 Shaft Mounted Gear Units and Gearmotors
 - M-02.1.6 Planetary Gear Units and Gearmotors
 - M-02.1.7 High Power Gear Units
 - M-02.1.8 Low-Backlash Gear Units
 - M-02.1.9 Speed Change Gear Units
 - M-02.1.10 Special Gear Units
 - M-02.1.11 Speed Increasers
 - M-02.1.12 Motorized Drums
 - M-02.1.13 Other Mechanical Transmissions for Stationary Applications
- M-02.2 Mechanical Transmissions for Vehicles
 - M-02.2.1 Gear Units for Agricultural Vehicles
 - M-02.2.2 Gear Units for Construction Machinery
 - M-02.2.3 Marine Transmissions
 - M-02.2.4 Train Transmissions
 - M-02.2.5 Transmissions for Automotive
 - M-02.2.6 Transmissions for Trucks and Buses
 - M-02.2.7 Gear Units for other Vehicles

M-02.3 Speed Variators

- M-02.3.1 Mechanical Speed Variators
- M-02.3.2 Hydraulic Speed Variators
- M-02.3.3 Cone Pulley Speed Variators (Belt)
- M-02.3.4 Other Speed Variators
- M-02.4 Actuating Mechanisms
 - M-02.4.1 Cam Equipment
 - M-02.4.2 Other Actuating Mechanisms

M-03 TRANSMISSION ELEMENTS

- M-03.1 Couplings and Clutches
 - M-03.1.1 Rigid and Torsional Couplings
 - M-03.1.2 Flexible Couplings
 - M-03.1.3 Friction Clutches
 - M-03.1.4 Electromagnetic Clutches

- M-03.1.5 Centrifugal Couplings
- M-03.1.6 Gear Couplings
- M-03.1.7 Free Wheel Clutches
- M-03.1.8 Torque Limiters
- M-03.1.9 Joint Couplings
- M-03.1.10 Spindles
- M-03.1.11 Disks for Clutches
- M-03.1.12 Locking Assemblies
- M-03.1.13 Clutch System
- M-03.1.14 Standard locking devices
- M-03.1.15 Shrink disk
- M-03.1.16 Other Couplings and Clutches
- M-03.2 Brakes
 - M-03.2.1 Mechanical Brakes
 - M-03.2.2 Electrical Brakes
 - M-03.2.3 Hydraulic Brakes
- M-03.3 Shafts
 - M-03.3.1 Cardan Shafts
 - M-03.3.2 Profiled Shafts
- M-03.4 Pulleys
 - M-03.4.1 V-Belt Pulleys
 - M-03.4.2 Flat-Belt Pulleys
 - M-03.4.3 Timing-Belt Pulleys
 - M-03.4.4 Other Pulleys
- M-03.5 Belts
 - M-03.5.1 V-Belts
 - M-03.5.2 Flat-Belts
 - M-03.5.3 Timing Belts
 - M-03.5.4 Other Belts
- M-03.6 Industrial Chains
 - M-03.6.1 Transmission Chains
 - M-03.6.2 Conveyor Chains
 - M-03.6.3 Other Industrial Chains

M-04 BEARINGS

- M-04.1 Ball bearings
 - M-04.1.1 Angular Contact Ball Bearings Single Row
 - M-04.1.2 Ball Bearings Double Row
 - M-04.1.3 Angular Contact Ball Bearings Double Row
 - M-04.1.4 Axial Ball Bearings and Cages
 - M-04.1.5 Yoke Type Track Rollers, Stud Type Track Rollers
 - M-04.1.6 Slewing Ring
 - M-04.1.7 Thin Section Bearings
 - M-04.1.8 Self-Aligning Bearings
 - M-04.1.9 Miniature Ball Bearings
 - M-04.1.10 Special Ball Bearings (General Bearings, Automotive, Textile, Machine Tool)

- M-04.2 Precision Ball Bearings
 - M-04.2.1 Precision Spindle Bearings
 - M-04.2.2 Screw Drives
- M-04.3 Cylindrical Roller Bearings
 - M-04.3.1 Axial Cylindrical Roller Bearings
 - M-04.3.2 Cylindrical Roller Bearings, with Cage
 - M-04.3.3 Cylindrical Roller Bearings, Special Design
 - M-04.3.4 Yoke Type Track Rollers, Stud Type Track Rollers with Cylindrical Roller Bearings
 - M-04.3.5 Cylindrical Roller Bearings Full Complement
 - M-04.3.6 Cylindrical Roller Axial Cages
 - M-04.3.7 Slewing Ring
 - M-04.3.8 Screw Drives
- M-04.4 Tapered Roller Bearings
- M-04.5 Spherical roller bearings
 - M-04.5.1 Self-Aligning Roller Bearings
 - M-04.5.2 Axial Cages with Spherical Roller
- M-04.6 Needle Roller Bearings
 - M-04.6.1 Axial Needle Roller Bearings
 - M-04.6.2 Combined Rolling Bearings
 - M-04.6.3 Combination Ball and Needle Bearings
 - M-04.6.4 Needle Roller Bearings, Chipless Machinings
 - M-04.6.5 Needle Roller Bearings, Full Complement
 - M-04.6.6 Radial Needle Cages
 - M-04.6.7 Axial Needle Cages
 - M-04.6.8 Yoke Type Rollers, Stud Type Rollers with Needles
 - M-04.6.9 Slewing Rings
 - M-04.6.10 Screw Drives
- M-04.7 Units With Roller-Bearings
 - M-04.7.1 Sheet Steel Housing
 - M-04.7.2 Plastic Housing
 - M-04.7.3 Cast Iron Housing
- M-04.8 Rolling Elements (Balls, Rollers, Needles)
- M-04.9 Plain Bearings
 - M-04.9.1 Plastic Self-Lubricating Bearings
 - M-04.9.2 Polymer Metal Bearings with Self-Lubrication
 - M-04.9.3 Self-Lubricating Bimetallic Bearings
 - M-04.9.4 Integral Self-Lubricating Bearings
- M-04.10 Spherical Plain Bearings and Rod Ends

M-05 LINEAR SYSTEMS

- M-05.1 Linear Plain Bearings and shafts
 - M-05.1.1 Linear Plain Bearings
 - M-05.1.2 Linear Ball Bearings
 - M-05.1.3 Shaft Bearing Supports
 - M-05.1.4 Shafts (Smooth, with Contour)
- M-05.2 Ball Bearings Monorail Guidance Systems
 - M-05.2.1 Ball Bearings Monorail Guidance Two Row-Systems
 - M-05.2.2 Linear Recirculating Ball Bearings/Ball Monorail Systems
 - M-05.2.3 Miniatur – Recirculating Units
 - M-05.2.4 Recirculating Units – 6 Rows
 - M-05.2.5 Recirculating Units – 4 Rows
 - M-05.2.6 Telescopic-Recirculating Systems
 - M-05.2.7 Flat Cage Guides
- M-05.3 Roller Bearings Monorail Guidance Systems
- M-05.4 Track roller Linear Guides (Steel-Aluminium-Covered)
- M-05.5 Flat Guides
- M-05.6 Linear Actuators with Tooth Belt Drive
- M-05.7 Linear Actuators with Screw Drive
- M-05.8 Linear Actuators with Rack
- M-05.9 Linear Actuators with Linear Motor
- M-05.10 Linear Actuators with Air Pressure Drive
- M-05.11 Electric Cylinders/ Electromagnetic Actuators
- M-05.12 Screw Drives
- M-05.13 Precision Positioning Tables
- M-05.14 Grinded Ball Screws
 - M-05.14.1 Planetary Roller Screws
 - M-05.14.2 Rolling Ring Screws
 - M-05.14.3 Grinded Ball Screw Drive
 - M-05.15 "Rolled" Ball Screw Drive



REPERTORIO *DIRECTORY*
2024 | 2025





INDICE
CONTENTS

CHI È FEDERTEC
WHO IS FEDERTEC

4



I NUMERI DEL SETTORE
SECTOR NUMBERS

8



LE ATTIVITÀ FEDERTEC
FEDERTEC ACTIVITIES

10



12

RIFERIMENTO PRODOTTI
PRODUCT REFERENCE



28

ELENCO ASSOCIATI
LIST OF MEMBERS



79

SCHEDE ASSOCIATI
MEMBERS' PRESENTATION

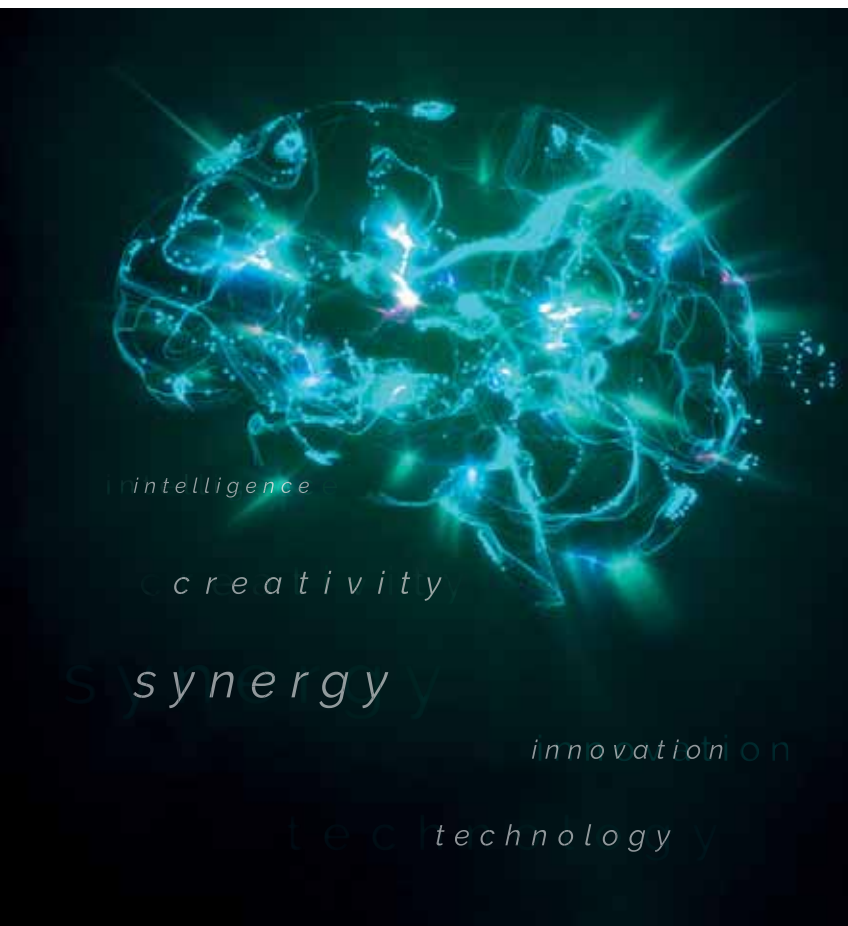

Chi è FEDERTEC

who is FEDERTEC

In un contesto evolutivo dove le tecnologie di prodotto tendono sempre più a convergere, **FEDERTEC**, l'Associazione che rappresenta l'industria italiana della Componentistica e delle Tecnologie Meccatroniche per la Potenza Fluida, la Trasmissione di Potenza, il Controllo e l'Automazione Intelligente di Prodotti e Processi Industriali, si conferma il punto di riferimento per il settore dell'automazione industriale, focalizzato sull'integrazione delle diverse tecnologie utilizzate e volto a rappresentare l'intera filiera.

Dopo la costituzione di FEDERTEC del 2019 grazie alla fusione di **ASSIOT** (Associazione Italiana Costruttori Organi di Trasmissione e Ingranaggi) e **ASSOFLUID** (Associazione Italiana dei Costruttori ed Operatori del Settore Oleoidraulico e Pneumatico), da aprile 2022 anche **FNDI** (Federazione Nazionale della Distribuzione Industriale) è stata incorporata in FEDERTEC, aggiungendo un nuovo tassello alla filiera delle tecnologie meccatroniche.

*In the highly developed context where product technology tends to converge, **FEDERTEC**, the Association representing the Italian industry of Mechatronic Technologies and Components for Fluid Power, Power Transmission, Smart Automation and Control of Industrial Products and Processes, is the point of reference for the industrial automation sector, focused on the integration of the different technologies and aimed at representing the entire value chain.*

*After the establishment of FEDERTEC in 2019 thanks to the merger of **ASSIOT** (Italian Transmission Elements and Gears Manufacturers Association) and **ASSOFLUID** (Italian Fluid Power Association), also **FNDI** (National Federation of Industrial Distribution) has been incorporated into FEDERTEC from April 2022, adding a new piece to the mechatronic technologies chain.*



associati members

Oggi **FEDERTEC** conta circa 290 aziende associate, che rappresentano un punto di riferimento per il settore dell'automazione industriale, all'avanguardia per competitività, qualità, affidabilità e prestazioni di prodotti e sistemi, focalizzato sulla convergenza e interconnessione di diverse tecnologie: **fluidica, meccanica, elettronica, digital e software, misura e controllo**, ciascuna con le proprie competenze e peculiarità.

Today **FEDERTEC** has about 290 member companies, which represent a point of reference for the industrial automation sector, well known for its competitiveness, quality, reliability and performances of products and systems, focused on the convergence and interconnection of different technologies: **fluidics, mechanics, electronics, digital and software, measurement and control**, each with its own know-how and characteristics.

obiettivi objectives

L'Associazione coordina, tutela e promuove gli interessi tecnici ed economici del comparto, rappresentando efficacemente in tutto il mondo il Made in Italy settoriale.

In particolare, si propone di:

- > **RIUNIRE** i suoi associati per la trattazione di questioni di comune interesse.
- > **RAPPRESENTARE** le aziende associate presso Istituti, Enti, Organismi nazionali e internazionali.
- > **STUDIARE e RISOLVERE** nell'interesse delle aziende associate problematiche di carattere tecnico, normativo ed economico.
- > **FAVORIRE** la conoscenza e la maggior diffusione delle tecnologie e dei prodotti del settore.
- > **FORMARE** nuove risorse umane competenti, attraverso l'istruzione tecnica e professionale.
- > **PROCEDERE** alla raccolta e all'elaborazione di dati statistici di mercato.

The Association coordinates, protect and promotes the technical and economic interests of the sector, representing the Made in Italy worldwide.

To achieve such a policies, the Association:

- > **MEETS** its members to discuss issues of common interest.
- > **REPRESENTS** member companies within national and international institutes, agencies and organizations.
- > **EXAMINES and RESOLVES**, on behalf of members, technical, legislative and economic issues.
- > **ENCOURAGES** knowledge and diffusion of technologies and products of the sector.
- > **TRAINS** new competent human resources through professional and technical education.
- > **MONITORS** economic cycles by collecting and processing market data.



network

FEDERTEC aderisce a **Confindustria**, la principale organizzazione rappresentativa delle imprese manifatturiere e di servizi in Italia, e a **Federmacchine** - Federazione Nazionale delle Associazioni dei Produttori di Beni Strumentali e loro accessori destinati allo svolgimento di processi manifatturieri dell'industria e dell'artigianato - che racchiude dodici associazioni di costruttori di macchine. FEDERTEC aderisce inoltre al **CETOP** (Comitato Europeo delle Trasmissioni Oleoidrauliche e Pneumatiche) e ad **EUROTRANS** (Comitato Europeo delle Associazioni dei Costruttori di Ingranaggi e Organi di Trasmissione), attraverso i quali si confronta e collabora con le altre Associazioni europee di settore.

***FEDERTEC** joins **Confindustria**, the leading organization representing manufacturing and service companies in Italy, and **Federmacchine** - National Federation of Association of Manufacturers of Capital Goods and Ancillary Products intended for Industrial and Handicrafts Manufacturing Processes - which represents twelve associations of machinery manufacturers. **FEDERTEC** is also member of **CETOP** (European Fluid Power Committee) and **EUROTRANS** (European Committee of Associations of Manufacturers of Gears and Transmission Elements), through which collaborates with other European and world associations.*

➤ organo ufficiale di stampa *official magazine*

InMotion - Tecnologie per la trasmissione di potenza e l'automazione - è la rivista tecnica, nata dalla collaborazione con la casa editrice Publitec, che offre una panoramica completa su componenti meccanici, sistemi meccatronici, oleodinamica, pneumatica, automazione e sicurezza. È pubblicata in italiano e inglese ed è distribuita in formato cartaceo in Italia e in formato digitale nel resto del mondo.

InMotion - Technologies for power transmission and automation - is the technical magazine, born from the collaboration with the publishing house Publitec, which offers a complete overview of mechanical components, mechatronic systems, hydraulics, pneumatics, automation and safety. The magazine is published in Italian and English and is distributed in hard copy in Italy and digitally in the rest of the world.

➤ repertorio *directory*

Il **Repertorio FEDERTEC**, alla sua terza edizione, costituisce uno strumento fondamentale per comprendere e conoscere l'offerta esistente in Italia di componenti, sistemi, tecnologie e competenze per l'automazione e il controllo di prodotti e processi industriali. Le informazioni merceologiche dei nostri Associati trovano completamento sul sito internet dell'Associazione **federtec.it**, all'interno del quale è presente una specifica sezione costantemente aggiornata.

The **FEDERTEC Directory**, at its third edition, is a primary tool to understand and to know the existing offer in Italy of components, systems, technologies and know-how for the automation and control of industrial products and processes. The product information of our members are also present on the web site **federtec.it**, inside a specific section which is constantly updated.



I numeri del SETTORE

SECTOR numbers

Le associate **FEDERTEC** rappresentano uno spaccato importante dell'economia italiana ed esprimono valori di assoluto rilievo con un fatturato di settore complessivo che a fine 2023 ha sfiorato i 14,7 miliardi di euro ed un valore del mercato nazionale di oltre 10 miliardi di euro, che portano **l'Italia ad essere tra i leader mondiali del comparto.**

Per una stima corretta dei numeri di FEDERTEC, a queste performance, già di per sé significative, andrebbero aggiunte anche quelle di tutta la filiera che utilizza tecnologie diverse da meccanica e fluidica - tra le quali elettronica ed informatica in primis - per realizzare Componentistica e Sistemi Meccatronici per la Trasmissione e il Controllo del Movimento e della Potenza; la stima del fatturato dell'industria italiana di questo macro settore è di circa 40 miliardi di euro.

FEDERTEC** member companies represent an important cross-section of the Italian economy and express values of absolute importance with a total sector turnover that, in 2023, reached 14.7 billion euro and a national market value of 10.3 billion euro, which lead **Italy to be among the world leaders.

*For a correct estimate of the numbers of FEDERTEC, to these performances, already significant, should also be added those of the whole production chain that uses technologies other than mechanics and fluidics - first of all electronics and electricity - to make **Mechatronics Components and Systems for the Transmission and Control of Movement and Power:** the estimated turnover of the Italian industry in this macro sector is around 40 billion euro.*



> insieme siamo più forti
stronger together



H **OLEOIDRAULICA**
HYDRAULICS

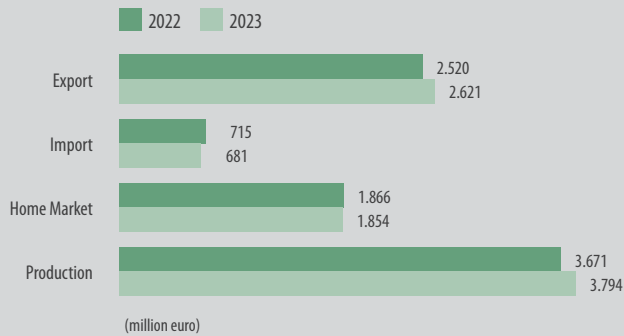

P **PNEUMATICA**
PNEUMATICS

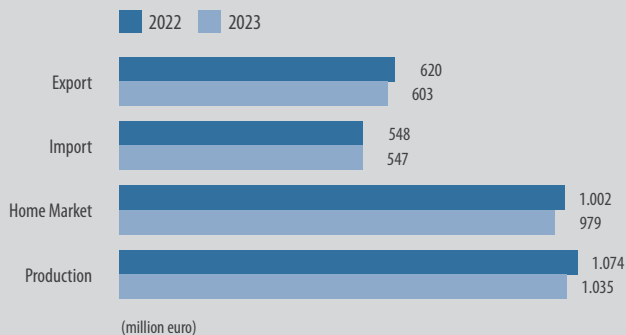

M **TRASMISSIONI MECCANICHE**
MECHANICAL TRANSMISSIONS

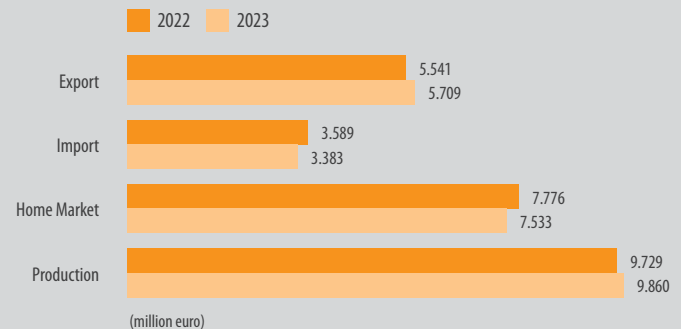

Le attività FEDERTEC

FEDERTEC activities



L'Associazione mette a disposizione dei propri soci molteplici servizi che coprono diverse aree di interesse

Statistica

Indagini di mercato e analisi statistiche volte a monitorare i trend del mercato nazionale ed internazionale del comparto.

Tecnica

Consulenza alle aziende associate in merito a direttive europee, norme tecniche nazionali ed internazionali e supporto all'interpretazione di leggi e regolamenti di interesse per il settore.

Formativa

Organizzazione di corsi specifici di natura tecnica e commerciale - **FEDERTEC Academy** - per affrontare le sfide che il mercato pone quotidianamente; certificazione di centri ed istituti di formazione, nell'ambito del progetto "CETOP education program," per la formazione su più livelli di personale specializzato per il settore della potenza fluida.



The Association provides its members with many services covering different areas of interest

Statistics

Market surveys and statistical analyses aimed at monitoring the trends of the national and international sector market.

Technology

Support to member companies on European directives, national and international technical standards and support for the interpretation of laws and regulations of interest.

Education

Organization of specific technical and commercial courses - **FEDERTEC Academy** - to face the daily market challenges; certification of training centers and institutes, in conformity to the "CETOP education program", for the training of personnel in the fluid power sector on different levels of qualifications.



Promozionale

Strumenti a supporto per la promozione del settore e delle aziende: sito internet, repertorio associativo, rivista InMotion, partecipazione a manifestazioni fieristiche in Italia e nel mondo.

Convegni e seminari

Appuntamenti info-formativi su argomenti di interesse a supporto delle aziende, anche in collaborazione con altre organizzazioni appartenenti al sistema confindustriale.

Sono inoltre attivi in **FEDERTEC commissioni e gruppi di lavoro** focalizzati su temi specifici di particolare interesse per le aziende associate.

Promotional

Tools for the promotion of the sector and companies: website, directory, InMotion magazine, participation in trade fairs in Italy and worldwide.

Conferences and seminars

Info-training appointments on topics of interest, also in collaboration with other organizations belonging to the Confindustria system.

Commissions and working groups are also active in FEDERTEC focused on specific topics of particular interest to member companies.



Riferimento PRODOTTI

*PRODUCT
reference*

H OLEIDRAULICA HYDRAULICS

- | | | | |
|----|--|----|--|
| 01 | POMPE / PUMPS | 06 | ACCESSORI IMPIANTO / CIRCUIT ACCESSORIES |
| 02 | MOTORI / MOTORS | 07 | SISTEMI / SYSTEMS |
| 03 | CILINDRI E ATTUATORI / CYLINDERS AND ACTUATORS | 09 | PARTI E COMPONENTI / PARTS AND COMPONENTS |
| 04 | VALVOLE / VALVES | 10 | STRUMENTAZIONE / MEASURING INSTRUMENTATION |
| 05 | APPARECCHIATURE VARIE / VARIOUS EQUIPMENT | 11 | FLUIDI IDRAULICI / HYDRAULIC FLUIDS |

P PNEUMATICA PNEUMATICS

- | | | | |
|----|---|----|--|
| 03 | CILINDRI / CYLINDERS | 09 | PARTI E COMPONENTI / PARTS AND COMPONENTS |
| 04 | VALVOLE / VALVES | 10 | STRUMENTAZIONE / MEASURING INSTRUMENTATION |
| 05 | APPARECCHIATURE VARIE / VARIOUS EQUIPMENT | 12 | COMPONENTI PER IL VUOTO / VACUUM COMPONENTS |
| 06 | ACCESSORI IMPIANTO / CIRCUIT ACCESSORIES | 13 | APPARECCHIATURE PER
LUBRIFICAZIONE CENTRALIZZATA /
CENTRALIZED LUBRICATION EQUIPMENT |
| 08 | APPARECCHI TRATTAMENTO ARIA /
AIR CONDITIONING UNITS | | |

M TRASMISSIONI MECCANICHE MECHANICAL TRANSMISSIONS

- | | |
|----|---|
| 01 | INGRANAGGI / GEARS |
| 02 | TRASMISSIONI MECCANICHE /
MECHANICAL TRANSMISSIONS |
| 03 | ELEMENTI DI TRASMISSIONE /
TRANSMISSION ELEMENTS |
| 04 | CUSCINETTI / BEARINGS |
| 05 | SISTEMI LINEARI / LINEAR SYSTEMS |

AZIENDA / COMPANY

	H											P							M					
	01	02	03	04	05	06	07	09	10	11	03	04	05	06	08	09	10	12	13	01	02	03	04	05
2 EFPE ENGINEERING SRL	TRATTAMENTI SUPERFICIALI / SURFACE TREATMENTS																							
A.I.P.I. - ASSOCIAZIONE ITALIANA PROGETTISTI INDUSTRIALI	ASSOCIAZIONE / ASSOCIATION																							
A.I.R. PNEUMATIC CENTER SRL											■	■	■	■	■	■	■	■	■					
A.N.I.P.L.A. - ASSOCIAZIONE NAZIONALE ITALIANA PER L'AUTOMAZIONE	ASSOCIAZIONE / ASSOCIATION																							
A.PI. SRL											■	■		■	■	■	■							
A.T.T.I. SRL																		■	■	■	■	■		
AEGI CLAMPS SRL						■		■						■		■								
AIDAM - ASSOCIAZIONE ITALIANA DI AUTOMAZIONE MECCATRONICA	ASSOCIAZIONE / ASSOCIATION																							
AIDRO SRL				■	■		■	■	■															
AIGNEP SPA											■	■	■	■	■	■	■							
AIR FLUID SOLUTIONS SAS			■	■		■		■	■		■	■	■	■	■	■	■					■		
AIRCOMP BY STAMPOTECNICA SRL											■	■		■	■									
AIRON SRL											■	■	■	■	■	■	■							
AIRWORK PNEUMATIC EQUIPMENT SRL											■	■		■	■	■	■							
AM TESTING SRL	R&S E PROVE MECCANICHE / MECHANICAL R&D AND TESTING CENTER																							
ANGST+PFISTER SPA						■		■						■		■								
ARELLE COMPONENTI OLEODINAMICI SRL	■	■	■	■	■	■	■	■	■	■	■	■	■	■	■	■	■					■		
ARGO-HYTOS SRL	■			■	■	■	■	■	■															
AROL AUTOMAZIONE SRL	■	■	■	■	■	■	■	■	■		■	■	■	■	■	■	■					■		
ARTEC SRL											■													
AS ASTON SEALS SPA								■								■								
ATC (ITALIA) SRL											■	■	■	■	■	■	■					■		
ATI MORGANTI SRL											■	■	■	■	■	■	■	■	■	■	■	■		
AZ PNEUMATICA SRL											■	■	■	■	■	■	■							
BART SRL				■		■			■					■			■							
BERARMA SRL	■			■																				
BERGAMO TRASMISSIONI SRL																		■	■	■	■	■		

AZIENDA / COMPANY

	H											P													M				
	01	02	03	04	05	06	07	09	10	11	03	04	05	06	08	09	10	12	13	01	02	03	04	05					
BIANCHI INDUSTRIAL SPA A SOCIO UNICO								■	■		■	■	■	■	■	■	■	■	■	■	■	■	■	■					
BIBUS ITALIA SRL	■	■		■	■	■	■	■	■											■	■								
BICELLI SRL			■																										
BLB SRL				■																									
BODYCOTE TRATTAMENTI TERMICI SPA	TRATTAMENTI TERMICI / HEAT TREATMENTS																												
BONDIOLI & PAVESI SPA	■	■		■	■	■	■	■											■	■	■								
BONFIGLIOLI SPA																			■	■									
BOSCH REXROTH SPA	■	■	■	■	■	■	■	■	■													■	■						
BÜRKERT ITALIA SPA									■		■					■	■												
C.M.C. ITALIA SRL								■								■													
C.MATIC SPA						■					■			■															
C.O.P.E. COMPONENTI OLEODINAMICA PNEUMATICA ELETTRONICA SRL	■	■	■	■	■	■	■	■	■	■	■	■	■	■	■	■	■	■											
CADENAS ITALIANA SRL	SOFTWARE PER CATALOGHI ELETTRONICI DI PRODOTTO / SOFTWARE FOR ELECTRONIC CATALOGS																												
CAMERANO DI MICHELA MUSSO & C. SAS											■	■	■	■	■	■	■	■											
CAMOZZI ADVANCED MANUFACTURING SPA	MANIFATTURA AVANZATA-MANIFATTURA ADDITIVA / ADVANCED MANUFACTURING-ADDITIVE MANUFACTURING																												
CAMOZZI AUTOMATION SPA											■	■	■	■	■	■	■	■											
CAMOZZI DIGITAL & MECHATRONICS SRL	CONSULENZA E SOLUZIONI SOFTWARE PER PROCESSI INDUSTRIALI / CONSULTING AND SOLUTIONS SOFTWARE FOR INDUSTRIAL PROCESSES																												
CAMOZZI GROUP SPA	HOLDING																												
CAMOZZI TECHNOPOLYMERS SRL	STAMPAGGIO PLASTICA / PLASTIC MOULDING																												
CAMPRESS SRL	STAMPAGGIO A CALDO OTTONE / HOT MOULDING OF BRASS																												
CARL ZEISS SPA	METROLOGIA E MICROSCOPIA INDUSTRIALE / INDUSTRIAL METROLOGY AND MICROSCOPY																												
CARRARO SPA																			■	■	■								
CASA DEL CUSCINETTO DI G. COLOMBO & C. SPA								■								■		■	■	■	■	■	■						
CASA DEL CUSCINETTO SPA	■		■				■	■			■	■	■	■	■	■	■	■	■	■	■	■	■						
CASAGRANDE INGRANAGGI SRL																			■										
CATTINI & FIGLIO SPA																			■										
CBF SRL	■			■			■																						

AZIENDA / COMPANY

	H											P							M					
	01	02	03	04	05	06	07	09	10	11	03	04	05	06	08	09	10	12	13	01	02	03	04	05
DLM SRL	■	■	■	■	■	■	■	■	■	■	■	■	■	■	■	■	■							
DMMM - POLITECNICO DI BARI	UNIVERSITÀ / UNIVERSITY																							
DTG - UNIVERSITÀ DEGLI STUDI DI PADOVA	UNIVERSITÀ / UNIVERSITY																							
DUPLOMATIC MS SPA	■		■	■	■	■	■	■	■	■														■
E.P.P. EURO PRESS PACK SPA	■		■	■		■	■	■	■	■														
EFFEGI SYSTEMS SRL			■			■	■																	
ELETTROTEC SRL										■							■	■						
EMERSON AUTOMATION FLUID CONTROL & PNEUMATICS ITALY SRL											■	■	■	■	■	■	■	■						■
EMMEGI SPA					■																			
EMMEQUATTRO SRL																				■	■			
EMPORIO DEL CUSCINETTO SRL									■							■					■	■	■	■
ENERPAC SPA	■		■	■	■	■	■		■	■														
EUROCONIC SRL																						■		
EUROMAT SRL	■	■		■			■														■	■	■	
EUROSWITCH SPA									■								■	■						
EVP SYSTEMS SRL											■	■	■	■	■	■	■	■						■
F.LLI BONO SPA	■	■	■	■	■	■	■	■	■	■	■	■	■	■	■	■	■	■	■	■	■	■	■	■
F.LLI GIACOMELLO SRL									■								■							
F.LLI TOGNELLA SPA				■	■				■		■						■							
F.S.S. F.LLI STARGIOTTI SNC DI STARGIOTTI SIMONE E C.	■	■	■	■	■	■	■	■	■	■	■	■	■	■	■	■	■			■	■	■	■	■
FACCHINETTI SRL						■			■		■	■		■			■					■	■	
FAI FILTRI SRL					■										■			■						
FAIZANÈ SPA				■		■		■	■		■	■	■	■	■	■	■	■		■		■		
FARBO SRL											■	■	■	■	■		■	■						
FARO OLEODINAMICA SRL	■	■	■	■	■	■	■	■	■															
FARO SRL																				■		■	■	
FASTER SRL				■		■																		

AZIENDA / COMPANY

	H											P													M				
	01	02	03	04	05	06	07	09	10	11	03	04	05	06	08	09	10	12	13	01	02	03	04	05					
FERRANTI SRL																								■	■				
FESTO SPA											■	■	■	■	■		■	■											
FG-TECH SRL										■																			
FIAR SRL	■	■	■	■	■	■	■	■	■	■																			
FILTREC SPA					■				■																				
FITCONTASTA SRL	■	■	■	■	■	■	■	■	■		■	■	■	■	■		■	■	■	■	■	■	■	■					
FLUCOM SRL				■																									
FLUID-APP SRL				■																									
FMI FRANCESCHI SRL											■	■	■	■	■	■	■	■	■	■	■	■	■	■					
FONDERIE MORA GAVARDO SPA	FUSIONE GHISA E ALLUMINIO / CAST IRON AND ALUMINIUM CASTING																												
FORNITURE INDUSTRIALI DELLACASA SRL																				■	■	■	■	■					
FRANCIA SRL																				■	■	■	■	■					
FRIDLE GROUP SRL	■	■	■	■	■	■	■	■	■		■	■		■	■	■	■												
GANDINI SRL																				■		■							
GATES SRL CON SOCIO UNICO						■																■							
GEMELS SPA		■		■		■																							
GIORGIO BONORI ENGINEERING SRL	SOFTWARE DI CALCOLO E CONSULENZA PER TRASMISSIONI MECCANICHE / CALCULATION SOFTWARE AND CONSULTING FOR MECHANICAL TRANSMISSION																												
GLEASON SALES CORPORATION	MACCHINE UTENSILI / MACHINE TOOLS																												
GRAZIOLI SRL	■	■	■	■	■	■	■	■	■	■	■	■	■	■	■	■	■	■	■	■	■	■	■	■	■				
GRICES HYDRAULIC CYLINDERS SRL			■					■	■		■																		
GRUPPO MECCATRONICO UNINDUSTRIA REGGIO EMILIA	ASSOCIAZIONE / ASSOCIATION																												
GTA LOMBARDIA SRL	■	■	■	■	■	■	■	■	■																				
GUARNITEC SRL								■								■													
GUMEC SRL				■																									
H.P.S. CENTRO OLEODINAMICO DIVISIONE MOBILE SRL	■	■	■	■	■	■	■	■	■	■	■	■	■	■	■	■	■	■											
HANNOVER FAIRS INTERNATIONAL GMBH	ENTE FIERISTICO / TRADE FAIR ORGANIZER																												
HANSA-TMP SRL	■	■	■	■	■		■	■																					

AZIENDA / COMPANY

	H											P													M				
	01	02	03	04	05	06	07	09	10	11	03	04	05	06	08	09	10	12	13	01	02	03	04	05					
HAWE ITALIANA SRL	■		■	■	■	■	■		■																				
HGEARS PADOVA SPA																					■	■	■						
HI-FLEX ITALIA SRL	■		■	■	■	■	■		■	■																			
HOMBERGER SPA																							■						
HV HYDRAULIC SRL	■			■																									
HYDRA HYDRAULICS SRL				■	■		■		■																				
HYDRECO HYDRAULICS ITALIA SRL	■	■	■	■	■		■															■							
HYDRO HOLDING SPA							■							■															
HYDRONIT SRL	■	■		■	■	■	■	■	■																				
HYDROTECHNIK ITALIA SRL A SOCIO UNICO					■	■			■					■			■												
HYDROVEN SRL	■	■	■	■	■	■	■	■	■																				
I.M.M. HYDRAULICS SPA						■																							
IMETECH POWER TRANSMISSIONS SRL																						■							
INDUSTRIAL FORNITURE MORO SNC	■	■	■	■	■	■		■	■		■	■	■	■	■	■	■	■	■	■	■	■	■	■					
INGRANAGGI MOREALI MARIO SPA																					■								
INNSE-BERARDI SPA	MACCHINE UTENSILI / MACHINE TOOLS																												
INTERMOT SRL		■																											
INTERTRACO (ITALIA) SPA				■		■																							
ISTITUTO DI SCIENZE E TECNOLOGIE PER L'ENERGIA E LA MOBILITÀ SOSTENIBILI (STEMS - CNR)	RICERCA APPLICATA / APPLIED RESEARCH																												
ITALGEAR SRL A SOCIO UNICO																					■								
KISSOFT AG	SOFTWARE DI CALCOLO PER TRASMISSIONI MECCANICHE / CALCULATION SOFTWARE FOR MECHANICAL TRANSMISSION																												
KLINGELBERG ITALIANA SRL	MACCHINE UTENSILI / MACHINE TOOLS																												
KNF ITALIA SRL	■												■																
KONFIT ITALIA SRL A SOCIO UNICO											■	■		■	■	■	■												
LA.RA. DI LACEDRA CATALDO MARCO & CO. SAS	CONSULENZA PROCESSI PRODUTTIVI / CONSULTING PRODUCTION PROCESSES																												
LELI SRL																							■	■	■				
LEONARDO SPA																					■	■	■						

AZIENDA / COMPANY

	H											P											M				
	01	02	03	04	05	06	07	09	10	11	03	04	05	06	08	09	10	12	13	01	02	03	04	05			
LINK INTERNATIONAL SRL																				■	■	■	■	■			
LOPIGOM SPA							■									■											
M.B. ITALIA SRL SOCIO UNICO						■																					
MAAG ITALY SRL																				■			■				
MACTUBI SPA						■								■													
MAGNA PT SPA																				■	■						
MAP SERVICE SRL											■	■	■	■	■	■	■	■									
MARCEGAGLIA CARBON STEEL SPA				■					■							■											
MARZOCCHI POMPE SPA	■	■																									
MATRIX SPA												■			■			■									
MCI - MARZORATI COMPONENTI INDUSTRIALI SPA									■							■				■		■	■	■			
MEBEX SRL	■	■	■	■	■	■	■	■	■	■	■	■	■	■	■	■	■	■	■								
MELUCCI SRL																				■	■	■	■	■			
MESSE FRANKFURT ITALIA SRL	ENTE FIERISTICO / TRADE FAIR ORGANIZER																										
METAL WORK SPA											■	■		■	■	■	■	■									
METALCASTELLO SPA																			■								
MICROINGRANAGGI SRL																			■	■	■						
MINI TOOLS COATING SRL	UTENSILI E RIVESTIMENTI UTENSILI PER INGRANAGGI / TOOLS AND TOOL COATING FOR GEARS																										
MISELLI SRL			■	■	■	■		■	■																		
MITA OLEODINAMICA SPA			■	■	■	■																					
MONDIAL SPA																			■	■	■	■	■				
MOOG ITALIANA SRL	■		■	■				■																			
MOTOMECCANICA SRL																			■								
MOVECO SRL			■	■				■																			
NACHI EUROPE GMBH	■	■		■				■														■					
NET SEALS SRL	■	■	■	■	■	■		■	■																		
NET.FLUID SRL											■	■		■	■	■	■										

AZIENDA / COMPANY

	H											P											M				
	01	02	03	04	05	06	07	09	10	11	03	04	05	06	08	09	10	12	13	01	02	03	04	05			
NEWTON OFFICINE MECCANICHE SRL	CARPENTERIA METALLICA LEGGERA E MEDIA / METAL FABRICATION																										
NGH SRL	■	■	■	■	■	■	■	■	■	■																	
NORD FLUID SPA	■	■		■	■	■	■	■	■																		
NORGREN SRL			■	■			■	■	■	■	■	■	■	■	■	■	■				■			■			
NR DI NISOLI SRL CON UNICO SOCIO										■																	
NTN-SNR ITALIA SPA																						■	■	■			
NUOVA FIMA STORE SRL				■					■	■				■		■											
O.M.F.B. SPA HYDRAULIC COMPONENTS	■	■	■	■	■	■	■	■	■	■			■														
O.M.S. SORDELLA SRL	■	■	■	■	■	■	■	■	■											■	■	■	■	■			
O.T.I. SRL																				■							
OCMI-OTG SPA																				■	■						
OFFICINE MECCANICHE CIOCCA SPA				■		■																					
OILCOMP SRL				■			■																				
OILTRONIC DI ALFIERI GIANLUCA							■																				
OLEO MECCANICA INDUSTRIALE COMPONENTI SRL	■	■	■	■	■		■		■																		
OLEOBI SRL	■	■	■	■	■	■	■	■	■																		
OLEODINAMICA DELL'AVO SRL	■		■	■	■	■	■	■	■																		
OLEODINAMICA GECO SRL		■																									
OLEODINAMICA GIANNINI SRLU	■	■	■	■	■	■	■	■	■												■	■					
OLEODINAMICA MARCHESINI SPA				■																							
OLEODINAMICA MARTINALLI SRL	■	■	■	■	■	■	■	■	■	■	■	■	■	■	■	■	■	■									
OLEODINAMICA SEGUINI SRL	■	■	■	■	■	■	■	■	■																		
OLEOTEC SRL				■		■			■																		
OLEOWEB SRL	■			■			■																				
OMP OFFICINE MECCANICHE PIEMONTESI SRL																				■		■					
OMSI TRASMISSIONI SPA																					■	■					
OMT GROUP SPA				■	■	■			■																		

AZIENDA / COMPANY

	H											P											M						
	01	02	03	04	05	06	07	09	10	11	03	04	05	06	08	09	10	12	13	01	02	03	04	05					
OP SRL					■																								
OPTIBELT ITALIA SRL																										■			
ORTEA SPA	ENERGY EFFICIENCY																												
PI.U'. SRL	■	■	■	■	■	■		■	■		■	■	■	■	■	■	■	■	■	■	■	■	■	■	■	■	■	■	
P.SYSTEM AUTOMAZIONE SRL				■			■				■																		
PARKER HANNIFIN ITALY SRL	■	■	■	■	■	■	■	■	■		■	■	■	■	■	■	■	■	■	■	■	■	■	■	■	■	■	■	■
PASELLO TRATTAMENTI TERMICI SRL	TRATTAMENTI TERMICI / HEAT TREATMENTS																												
PEEN SERVICE SRL	TRATTAMENTI DEI METALLI / METAL TREATMENTS																												
PIOTTI OLEODINAMICA SRL				■		■			■																				
PNEUMAX SPA											■	■	■	■	■	■	■	■	■	■	■	■	■	■	■	■	■	■	■
PRECMAR SRL		■	■	■					■		■	■		■	■		■	■		■	■		■	■					
PROMATEC SPA	■	■		■	■	■								■	■					■									
PUBLITEC SRL	EDITORIA / PUBLISHING																												
QUINE BUSINESS PUBLISHER	EDITORIA / PUBLISHING																												
QUINZANI SRL																										■	■	■	■
R. GAROTTI & FIGLIO SRL	■	■		■	■	■		■	■	■	■	■	■	■	■	■	■	■	■	■	■	■	■	■	■	■	■	■	■
RACCORDTUBI SRL						■																							
RICAMBI BARS SAS											■	■	■	■	■	■	■	■	■	■	■	■	■	■	■	■	■	■	■
RONZIO OLEODINAMICA SPA	■	■			■	■																							
ROSSI SPA																										■			
RP SANTINI SRL						■																							
RUBINETTERIA PARMENSE DI SANTINI SERGIO & C. SNC	■					■		■																					
RUBIX SPA	■	■	■	■	■	■	■	■	■	■	■	■	■	■	■	■	■	■	■	■	■	■	■	■	■	■	■	■	■
RUDIFLEX SRL	■	■	■	■	■	■	■	■	■		■			■															
S.I.A.O. SRL SOCIETÀ ITALIANA APPLICAZIONI OLEODINAMICHE	■	■	■	■	■	■	■	■	■																				
SAE FLEX SPA	■	■	■	■	■	■	■		■																				
SAF SRL					■	■					■	■		■	■														

AZIENDA / COMPANY

AZIENDA / COMPANY	H											P											M						
	01	02	03	04	05	06	07	09	10	11	03	04	05	06	08	09	10	12	13	01	02	03	04	05					
SAI SPA		■																											
SAIP SRL					■																								
SALAMI SPA SOCIETÀ CON UNICO SOCIO	■	■		■																									
SCHAEFFLER ITALIA SRL																											■	■	■
SCHAEFFLER WATER PUMP BEARING ITALIA SRL																												■	
SECO TOOLS ITALIA SPA A SOCIO UNICO											UTENSILI / TOOLS																		
SERTO ITALIANA SRL				■		■					■			■															
SESINO COSTANTE SPA					■																								
SGM SRL	MACCHINARI PER LA SBAVATURA TERMICA E DISSODIATRICI / THERMAL DEBURRING MACHINERY AND DEOXIDIZERS																												
SISTEM PNEUMATICA SRL											■			■							■								
SKF INDUSTRIE SPA																											■		
SM - CYCLO ITALY SRL																										■			
SMART PROTECTIONS SRL						■									■														
SMC ITALIA SPA											■	■	■	■	■	■	■	■	■	■	■	■	■					■	
SOBA ENGINEERING SRLS	CONSULENZA / CONSULTING																												
SOGEAC SRL											■	■	■	■	■	■	■	■	■	■	■	■	■						
SOMASCHINI AUTOMOTIVE SRL																										■			
SOMASCHINI SPA																										■			
SOMI SRL	■	■	■	■	■	■	■	■	■	■	■	■	■	■	■	■	■	■	■	■	■	■	■						
STAUFF ITALIA SRL				■	■	■	■			■																			
STIMA SPA				■	■	■				■	■	■	■	■	■	■	■	■	■	■	■	■	■						
STRUMENTAZIONE INDUSTRIALE SRL				■						■	■				■		■												
STUCCHI SPA				■		■																							
STUDIO TECNICO TURCI	CONSULENZA / CONSULTING																												
SYSTEM FLUID SRL						■	■			■				■															
TAU SERVICE SRL	■	■	■	■	■	■	■	■			■	■	■	■	■	■	■	■	■	■	■	■	■	■	■	■	■	■	
TD MOUNTINGS SRL											■																		

AZIENDA / COMPANY

	H											P											M									
	01	02	03	04	05	06	07	09	10	11	03	04	05	06	08	09	10	12	13	01	02	03	04	05								
TECNICHE NUOVE MEDIA SPA												EDITORIA / PUBLISHING																				
TECNOEMME SRL												■	■	■	■	■	■	■	■	■	■											
TECNO-INGRANAGGI SRL																							■				■					
TEKNO UNO SRL												■	■	■	■	■	■	■	■	■	■											
TIERRE GROUP SPA												■				■																
TIMGLOBAL MEDIA SRL A SOCIO UNICO												EDITORIA / PUBLISHING																				
TIMKEN ITALIA SRL																										■	■	■				
TITAN ENGINEERING SPA												■	■	■						■												
TOR-MEC SRL																																
TOSONI FLUIDODINAMICA SPA	■	■	■	■	■	■	■	■	■	■	■	■	■	■	■	■	■	■	■	■												
TRACEPARTS SRL												SOFTWARE / SOFTWARE																				
UFI FILTERS HYDRAULICS SPA																																
UNIGASKET SRL																																
UNILAB LABORATORI INDUSTRIALI SRL												LABORATORIO PROVE / TEST LABORATORY																				
UTENSILDODI SRL												■	■	■	■	■	■	■	■	■	■	■	■	■	■	■	■	■	■	■	■	■
VARVEL SPA																																
VENETA BEARINGS SRL																							■	■	■	■	■					
VESTA AUTOMATION SRL												■	■	■	■	■	■	■	■													
VERZOLLA SRL	■	■	■	■	■	■	■	■	■	■	■	■	■	■	■	■	■	■	■	■	■	■	■	■	■	■	■	■				
VIVOIL OLEODINAMICA VIVOLO SRL	■	■																														
VUOTOTECNICA SRL																																
WAIRCOM MBS SPA												■	■				■	■	■	■	■	■										
WALVOIL SPA	■	■			■																											
WERMA ITALIA SRL												SEGNALETICA ACUSTICA E LUMINOSA / ACOUSTIC AND LIGHT SIGNALS																				
ZEC SPA																																

WORLD. LEADING. INDUSTRYSHOW

ENERGIZING A SUSTAINABLE INDUSTRY

Prodotti e soluzioni ad #HM25
hannovermesse.com

il più importante
evento espositivo
mondiale dedicato
alle tecnologie
per l'industria

PARTNER
COUNTRY
2025



Per maggiori informazioni:
Tel. 02 70.633.292
info@hftaly.com

HANNOVER MESSE
31 Marzo – 4 Aprile 2025
Hannover ■ Germania



EXPAND YOUR GLOBAL REACH Industry Events Worldwide



Il network globale delle fiere dedicate a automazione integrata, IT industriale, trasmissione e controllo di potenza



Shanghai, Cina
24-28 settembre 2024
industrial-automation-show.com



Shanghai, Cina
5 – 8 novembre 2024
28 – 31 ottobre 2025
ptc-asia.com



Chengdu, Cina
aprile 2025
cdiif.com



León, Messico
9 – 11 ottobre 2024
industrialtransformation.mx



Hannover, Germania
31 marzo – 4 aprile 2025
hannovermesse.de



Istanbul, Turchia
28 – 31 maggio 2025
win-eurasia.com



Singapore
14 – 16 ottobre 2024
industrial-transformation.com



Shenzhen, Cina
giugno 2025
sciif.com

Soluzioni per un mondo in moto



InMotion
Tecnologie per la trasmissione di potenza e l'automazione

Solutions for a world in motion



Published by Publi**Tec**

www.publiteonline.it - www.publiteonline.it/inmotion



Official publication of





ELENCO ASSOCIATI
LIST OF MEMBERS



Elenco ASSOCIATI

List of MEMBERS



2 EFFE ENGINEERING SRL

Via Brescia 45 - 25080 Soiano del Lago (BS)

Tel +39 0365 503061

Fax +39 0365 503433

www.2effe.com

info@2effe.com

- Pallinatura Controllata / *Shot Peening*
- Finitura Isotropica / *Isotropic Finishing*
- Rilievo Tensioni Residue / *Xrd Residual Stress Measurements*



A.I.P.I. ASSOCIAZIONE ITALIANA PROGETTISTI INDUSTRIALI

Via Rotondino 29 - 15033 Casale Monferrato (AL)

Tel +39 0142 75636

www.aipromes.com

segreteria@aipromes.com

- Associazione / *Association*



A.I.R. PNEUMATIC CENTER SRL

Via J. Gutenberg 6

47822 Santarcangelo di Romagna (RN)

Tel +39 0541 624314

Fax +39 0541 624649

www.airpneumatic.it

info@airpneumatic.it

H

P

03 - 04 - 05 - 06 - 08 - 09.2 - 10 - 12 - 13

M



A.N.I.P.L.A. ASSOCIAZIONE NAZIONALE ITALIANA PER L'AUTOMAZIONE

Viale Fulvio Testi 128 - 20092 Cinisello Balsamo (MI)

Tel +39 02 39289341

www.anipla.it

anipla@anipla.it

- Associazione / *Association*



A.P.I. SRL

Via Cornaggia 107 - 22076 Mozzate (CO)

Tel +39 0331 823511

Fax +39 0331 823480

www.api-pneumatic.com

info@api-pneumatic.com

H

P

03.1 - 03.2 - 03.3 - 03.4 - 04.1 - 04.2 - 04.3 - 04.4
06.1 - 06.2 - 06.3 - 06.5 - 06.6 - 08.1 - 08.2 - 08.3
08.4 - 09.1 - 09.2 - 10.1

M



A.T.T.I. SRL

Via Fratelli Cervi 3 - 21063 Cernusco sul Naviglio (MI)

Tel +39 02 92106954

www.atti.it

commerciale@atti.it

H

P

M

01 - 02.1 - 02.3 - 03.1 - 03.3 - 03.4 - 03.5 - 03.6
04.1.4 - 04.1.5 - 04.3.1 - 04.3.2 - 04.4 - 04.7 - 05



AIDRO SRL

Via Prati Bassi 36 - 21020 Taino (VA)

Tel +39 0331 960250

Fax +39 0331 960075

www.aidro.it

aidro@aidro.it

H

04 - 05.3 - 07.1 - 07.3 - 09.1 - 09.2 - 10.1 - 10.10

P

M



AEGI CLAMPS SRL

Via Einstein 54/56 - 20062 Cassano d'Adda (MI)

Tel +39 0363 65788

Fax +39 0363 65797

www.aegiclamps.it

giada@aegiclamps.it

H

06.10 - 09.10

P

06.10 - 09.10

M



AIGNEP SPA

Via Don G. Bazzoli 34 - 25070 Bione (BS)

Tel +39 0365 896626

Fax +39 0365 896561

www.aignep.com

aignep.it@aignep.com

H

03 - 03.1 - 03.2 - 03.3 - 03.4 - 04 - 04.1 - 04.3 - 04.4
04.10 - 05 - 05.2 - 05.10 - 06 - 06.1 - 06.2 - 06.3 - 06.6
08 - 08.1 - 08.2 - 08.3 - 08.4 - 08.10 - 09 - 09.2 - 10 - 10.1

M

p. 84



AIDAM - ASSOCIAZIONE ITALIANA DI AUTOMAZIONE MECCATRONICA

Viale Fulvio Testi 128 - 20092 Cinisello Balsamo (MI)

Tel +39 02 24416431

www.aidam.it

marketing@aidam.it

- Associazione / Association



AIR FLUID SOLUTIONS SAS

Via Milano 370 - 13856 Vigliano Biellese (BI)

Tel +39 015 811682

www.airfluidsolutions.it

info@airfluidsolutions.it

H

03.1 - 03.2 - 03.3 - 03.5 - 03.10 - 04.1 - 04.2
04.3 - 06.1 - 06.2 - 06.3 - 06.4 - 06.5 - 06.7
06.8 - 09.2 - 09.3 - 10

P

03 - 04 - 05.2 - 05.3 - 06 - 08 - 09.2 - 09.3 - 10 - 12

M



Automation

AIRCOMP BY STAMPOTECNICA SRL

Via Martiri di Cervarolo 5 - 42015 Correggio (RE)

Tel +39 0522 641840

www.aircomp.it

info@aircomp.it

p. 86



AIRON SRL

Via Marçinelle 8 - 45100 Rovigo (RO)

Tel +39 0425 471575

Fax +39 0425 404037

www.airon-pneumatic.com

info@airon-pneumatic.com

p. 88



AIRWORK PNEUMATIC EQUIPMENT SRL

Via Piemonte 3/5 - 20841 Carate Brianza (MB)

Tel +39 0362 645951

Fax +39 0362 645979

www.airwork.it

info@airwork.it

p. 90

H

P

03.1 - 03.4 - 03.10 - 04.1 - 04.4 - 04.10 - 06.3 - 08

M

H

P

03 - 04.1 - 04.3 - 04.4 - 05.2 - 05.3 - 06.1 - 06.3
06.4 - 06.5 - 06.6 - 08 - 09.1 - 09.2 - 10.1 - 10.3
10.4 - 10.5

M

H

P

03.1 - 03.2 - 03.3 - 03.4 - 04.1 - 04.3 - 04.4
06.1 - 06.2 - 06.3 - 06.4 - 06.6 - 08.1 - 08.2
08.3 - 08.4 - 09.2 - 10.1

M



Aeronautical and Mechanical Testing Centre

AM TESTING SRL

Via Padre Eugenio Barsanti 10 - 56121 Pisa (PI)

Tel +39 050 3160001

Fax +39 050 38351215

www.amtesting.it



ANGST+PFISTER SPA

Via Montefeltro 4 - 20156 Milano (MI)

Tel +39 02 82959 700

www.angst-pfister.com

itf@angst-pfister.com



ARELLE COMPONENTI OLEODINAMICI SRL

Via del Lavoro 62 - 20874 Busnago (MB)

Tel +39 039 6823535

www.arelle.it

info@arelle.it

- R&S nel settore trasmissioni meccaniche di potenza /
R&D in mechanical power transmissions
- Progettazione e realizzazione di banchi prova /
Design and manufacturing of test rigs
- Prove sperimentali / *Testing center*

H

06.1 - 06.4 - 09.3

P

06.1 - 09.3

M

H

01 - 02.1 - 02.3 - 02.4 - 02.5 - 03.1 - 03.2 - 03.3
04 - 05 - 06 - 07 - 09.1 - 09.2 - 09.3 - 10 - 11

P

03.1 - 03.2 - 03.4 - 04 - 05 - 06.1 - 06.2 - 06.3
06.5 - 08 - 09.1 - 09.2 - 09.3 - 10 - 13

M



p. 92

ARGO-HYTOS SRL

Via Salvador Allende 69/71 - 41122 Modena (MO)

Tel +39 059 7880801

www.argo-hytos.com

info.it@argo-hytos.com

H 01.1 - 04 - 05.2 - 05.10 - 06.5 - 06.10 - 07.1 - 07.3
09.1 - 10.1 - 10.10

P

M



AS ASTON SEALS SPA

Via S. Giacomo 43 - 41012 Carpi (MO)

Tel +39 059 653955

Fax +39 059 652844

www.astonseals.com

info@astonseals.com

H 09.3

P 09.3

M



AROL AUTOMAZIONE SRL

Via Olanda 5 - 21031 Gallarate (VA)

Tel +39 0331 794658

Fax +39 0331 793880

www.arolautomazione.it

info@arolautomazione.it

H 01 - 02 - 03.1 - 03.2 - 03.3 - 03.5 - 04 - 05 - 06.1
06.2 - 06.3 - 06.5 - 06.6 - 06.7 - 06.8 - 07 - 09.1
09.2 - 10

P 03 - 04 - 05 - 06 - 08 - 09.1 - 09.2 - 10.1 - 10.2
10.4 - 10.5 - 12 - 13

M



ATC (ITALIA) SRL

Via Manzoni 20 - 20020 Magnago (MI)

Tel +39 0331 307204

www.airtac.com

atc.it@airtac.com

H

P 03.1 - 03.2 - 03.3 - 03.4 - 04.1 - 04.3 - 04.4 - 05.3
06.1 - 06.3 - 08.1 - 08.2 - 08.3 - 08.4 - 09.1 - 09.2
09.3 - 09.5 - 10.1 - 12

M 05.2.1 - 05.2.2 - 05.2.3 - 05.2.5



p. 94

ARTEC SRL

Via Benedetto Zallone 24 - 44042 Cento (FE)

Tel +39 051 6836220

Fax +39 051 6830882

www.artec-pneumatic.com

info@artec-pneumatic.com

H

P 03.1 - 03.2 - 03.3 - 03.4

M

ATI MORGANTI SRL

Via Aldo Moro 36 - 59100 Prato (PO)

Tel +39 0574 6961

Fax +39 0574 400648

www.atimorganti.it

info@atimorganti.it

H

P 03 - 04 - 05 - 06 - 08 - 09.5 - 10.1 - 12 - 13

M 01 - 02.1 - 02.3 - 03 - 04 - 05



AZ PNEUMATICA SRL

Via Marco Biagi 6 Z.I. Longura - 20826 Misinto (MB)
Tel +39 02 966911
Fax +39 02 966911240
www.azpneumatica.com
azpneu@tin.it

H

P

03.1 - 03.2 - 03.3 - 03.4 - 04.1 - 04.2 - 04.3 - 04.4
04.10 - 05.2 - 06.1 - 06.3 - 06.4 - 06.5 - 06.6 - 08.1
08.2 - 08.3 - 08.4 - 09.2 - 09.3 - 09.4 - 09.5 - 10.1 - 12 - 13

M



BART SRL

Via Privata Pietro Magistretti 9 - 20128 Milano (MI)
Tel +39 02 27206577
www.bart-e.com
info@bart-e.com

H

04.1 - 06.3 - 10.1 - 10.2 - 10.10

P

06.3 - 10.1 - 10.2 - 10.10

M



BERARMA SRL

Via G. Parini 9 - 40033 Casalecchio di Reno (BO)
Tel +39 051 577182
Fax +39 051 578489
www.berarma.it
info@berarma.it

H

01.2 - 04.1

P

M



BERGAMO TRASMISSIONI SRL

Via Nosside 4 - 24020 Gorle (BG)
Tel +39 035 4175455
Fax +39 035 363013
www.bergamotrasmissioni.it
info@bergamotrasmissioni.it

H

P

M

01 - 02.1 - 02.3 - 03.1 - 03.3 - 03.4 - 03.5 - 03.6
04 - 05



BIANCHI INDUSTRIAL SPA A SOCIO UNICO

Via G. Zuretti 100 - 20125 Milano (MI)
Tel +39 02 37908881
www.bianchi-industrial.it
marketing@bianchi-industrial.it

H

09.3 - 10.1

P

03 - 04 - 05 - 06.1 - 06.2 - 06.3 - 06.5 - 06.6
08 - 09.1 - 09.2 - 09.3 - 10 - 12 - 13

M

01.1.3 - 01.1.5 - 02.1.1 - 02.1.2 - 02.1.3
02.1.4 - 02.1.5 - 02.1.6 - 02.1.7 - 02.1.8
02.3.1 - 03 - 04 - 05



BIBUS ITALIA SRL

Via Robert Fulton 27 - 40017 San Giovanni in Persiceto (BO)
Tel +39 051 893958
www.bibus.it
info@bibus.it

H

01 - 02 - 04 - 05 - 06 - 07.1 - 09.2 - 09.3
09.4 - 10

P

M

02.1.6



BICELLI SRL

Via Gianbattista Meli 112 - 25013 Carpenedolo (BS)
Tel +39 030 9965970
www.bicelli.it
info@bicelli.it

H 03.1

P

M



BLB SRL

Via Natta 1 - 36040 Brendola (VI)
Tel +39 0444 401141
www.blbhydraulic.com

H 04.1 - 04.2 - 04.3 - 04.4

P

M



BODYCOTE TRATTAMENTI TERMICI SPA

Via Moie 28 - 25050 Rodengo Saiano (BS)
Tel +39 030 6810209
Fax +39 030 6810218
www.bodycote.com
rodengo@bodycote.com

- Trattamenti termici / Heat treatments



BONDIOLI & PAVESI SPA

Via 23 Aprile 35/A - 46029 Suzzara (MN)
Tel +39 0376 5141
www.bondioli-pavesi.com
bp@bondioli-pavesi.com

H 01.1 - 01.3 - 02.1 - 02.3 - 02.5 - 04.1 - 04.2 - 04.3
04.4 - 05.1 - 05.3 - 06.6 - 07.1 - 07.2 - 09.2

P

M 02.2.1 - 02.2.2 - 02.2.3 - 02.2.6 - 02.3.1 - 02.3.2
03.1.1 - 03.1.2 - 03.1.3 - 03.1.5 - 03.1.6 - 03.1.7
03.1.8 - 03.1.11 - 03.2.3 - 03.3.1 - 03.3.2 - 04.6.1

p. 96



BONFIGLIOLI SPA

Via Cav. Clementino Bonfiglioli 1 - 40012 Calderara di Reno (BO)
Tel +39 051 6473111
www.bonfiglioli.com

H

P

M 02.1.1 - 02.1.2 - 02.1.4 - 02.1.5 - 02.1.6 - 02.1.7
02.1.9 - 02.2.1 - 02.2.2 - 02.3.1 - 03.2.1 - 03.2.2



BOSCH REXROTH SPA

S.S. Padana Superiore 11 - n. 41
20063 Cernusco sul Naviglio (MI)
Tel +39 02 923651
Fax +39 02 92365500
www.boschrexroth.it
info@boschrexroth.it

H 01.1 - 01.2 - 01.3 - 01.4 - 02.1 - 02.3 - 02.4 - 03.1
03.4 - 03.5 - 03.10 - 04 - 05.1 - 05.2 - 06.3 - 06.4
06.5 - 07 - 09.3 - 10.1 - 10.4

P

M 04.2.2 - 04.3.8 - 04.6.10 - 04.7 - 05.1.2 - 05.1.3 - 05.1.4
05.2.1 - 05.2.2 - 05.2.3 - 05.2.5 - 05.3 - 05.4 - 05.6
05.7 - 05.8 - 05.11 - 05.12 - 05.13 - 05.14 - 05.15

**BURKERT ITALIA SPA**

Centro Direzionale "BE" - Via Roma 108
20051 Cassina De' Pecchi (MI)
Tel +39 02 95907 1
www.burkert.it
info.italy@burkert.com

H 10.3 - 10.4 - 10.5

P 04.1 - 04.2 - 04.4 - 04.10 - 09.1 - 09.2 - 10.3
10.4 - 10.5 - 10.10

M

**C.M.C. ITALIA SRL**

Cascina S. Paolino 2 - 20871 Vimercate (MB)
Tel +39 039 6815240
Fax +39 039 6815236
www.cmcitalia.biz
info@cmcitalia.biz

H 09.4 - 09.5 - 09.10

P 09.4 - 09.5 - 09.10

M

**C.MATIC SPA**

Via G. Matteotti 32 - 20833 Giussano (MB)
Tel +39 0362 805246
Fax +39 0362 805262
www.cmatic.com
cmatic@cmatic.it

H 06.3

P 04.3 - 04.4 - 06.1 - 06.3 - 06.6

M



p. 100

**C.O.P.E. COMPONENTI OLEODINAMICA PNEUMATICA
ELETTRONICA SRL**

Via Papa Giovanni XXIII 15 - 25086 Rezzato (BS)
Tel +39 030 3760255
Fax +39 030 3365657
www.cope-italy.it
info@cope-italy.it

H 01.1 - 01.2 - 01.3 - 01.5 - 02.1 - 02.5 - 03.1
03.2 - 03.3 - 03.5 - 04 - 05 - 06 - 07.1 - 07.3
09.2 - 09.3 - 09.4 - 09.5 - 10 - 11

P 03 - 04 - 05.2 - 05.3 - 06 - 08 - 09.2 - 09.3
09.4 - 09.5 - 10 - 12 - 13

M

**CADENAS ITALIANA SRL**

Via Bassa dei Sassi 1/2 - 40138 Bologna (BO)
Tel +39 051 0416776
www.cadenas.it
marketing@cadenas.it

- Software per cataloghi elettronici di prodotto /
Software for electronic catalogs

**CAMERANO DI MICHELA MUSSO & C. SAS**

Via Galimberti 41 - 15121 Alessandria (AL)
Tel +39 0131 227022
Fax +39 0131 227070
www.camerano-sas.it
info@camerano-sas.it

H

P 03 - 04 - 05.2 - 05.3 - 06.1 - 06.3 - 06.4 - 06.5
06.6 - 08 - 09.1 - 09.2 - 09.3 - 10.1 - 10.5 - 12

M



Advanced Manufacturing

CAMOZZI ADVANCED MANUFACTURING SPA
Via R. Rubattino 81 - 20134 Milano (MI)
Tel +39 02 21711751
www.camozziadvancedmanufacturing.com
info@camozziadvancedmanufacturing.com

- Manifattura avanzata / *Advanced manufacturing*
- Manifattura additiva / *Additive manufacturing*
- Lavorazioni meccaniche di precisione /
Precision mechanical processing



Automation

CAMOZZI AUTOMATION SPA
Via Eritrea 20/I - 25126 Brescia (BS)
Tel +39 030 37921
Fax +39 030 2400464
www.camozzi.com
info@camozzi.com



03 - 04 - 05.3 - 05.10 - 06.1 - 06.3 - 06.5 - 06.6
06.10 - 08 - 09.1 - 09.2 - 09.3 - 10.1 - 10.4 - 12



p. 102



Digital & Mechatronics

CAMOZZI DIGITAL & MECHATRONICS SRL
Via Cassala 48/50 - 25126 Brescia (BS)
Tel +39 030 293046
www.camozzidigitalmechatronics.com
info@camozzidigitalmechatronics.com

- Consulenza e soluzioni software per la digitalizzazione
dei processi industriali / *Consulting and solutions for
digitalisation of industrial processes*



GROUP

CAMOZZI GROUP SPA
Via Eritrea 20/I - 25126 Brescia (BS)
Tel +39 030 37921
www.camozzigroup.com
info@camozzi.com

- Holding



Technopolymers

CAMOZZI TECHNOPOLYMERS SRL
Via XXV Aprile 5 - 25080 Castrezzone di Muscoline (BS)
Tel +39 0365 32128
www.camozzitechnopolymers.it
info@camozzi.com

- Stampaggio plastica / *Plastic moulding*



Brass Forging

CAMPRESS SRL
Via Cascina Croce 6/8 - 25050 Paderno Franciacorta (BS)
Tel +39 030 6857161
www.campress.com
info@campress.com

- Stampaggio a caldo ottone / *Hot moulding of brass*

**CARL ZEISS SPA**

Via Varesina 162 - 20156 Milano (MI)

Tel +39 02 937731

Fax +39 02 93773539

www.zeiss.itinfo.it@zeiss.com

- Macchine, soluzioni e servizi per metrologia e
microscopia industriale / *Machines, solutions
and services for industrial metrology and microscopy*

**CASA DEL CUSCINETTO SPA**

Via G. Puccini 728 - 55016 Porcari (LU)

Tel +39 0583 298822

www.casadelcuscinetto.itamm@casadelcuscinetto.it**H** 01.1 - 01.2 - 01.5 - 03.2 - 07.1 - 09.3 - 09.5**P** 03 - 04 - 05 - 06 - 08 - 09 - 10 - 12 - 13**M** 01 - 02 - 03 - 04 - 05**CARRARO SPA**

Via Olmo 37 - 35011 Campodarsego (PD)

Tel +39 049 9219111

Fax +39 049 9289111

www.carraro.comwebinfo@carraro.com**H****P****M** 01.1 - 01.2 - 01.3 - 01.5 - 01.6 - 02.1.1 - 02.1.2
02.1.6 - 02.1.7 - 02.1.8 - 02.1.10 - 02.2.1 - 02.2.2
02.2.7 - 02.3.2 - 03.1.3 - 03.1.13**CASAGRANDE INGRANAGGI SRL**

Via G. D'annunzio 3 - 21010 Cardano Al Campo (VA)

Tel +39 0331 262008

www.casagrandeingranaggi.itinfo@casagrandeingranaggi.it**H****P****M** 01.1 - 01.2 - 01.3 - 01.6 - 01.7**CASA DEL CUSCINETTO DI G. COLOMBO & C. SPA**

Strada Bertarino 4 - 15057 Tortona (AL)

Tel +39 0131 867180

www.casacuscinetto.cominfo@casacuscinetto.com**H** 09.3**P** 09.3 - 13**M** 01 - 02.1.1 - 02.1.4 - 02.1.6 - 02.2 - 02.3.1 - 02.3.3
03.1 - 03.3 - 03.4 - 03.5 - 03.6 - 04 - 05**CATTINI E FIGLIO SPA**

Via dell'Ecologia 1 - 20059 Casarile (MI)

Tel +39 02 900531

www.cattini.comsales@cattini.com**H****P****M** 01.1 - 01.2 - 01.6 - 01.7

p. 106



CBF SRL

Via Caboto 3 - 36075 Montecchio Maggiore (VI)
Tel +39 0444 499141/3
Fax +39 0444 499145
www.cbfnhydraulic.com
info@cbfnhydraulic.com

H 01.5 - 04 - 07.3 - 07.10

P

M

p. 110



a coesia company

CIMA SPA

Via Cairoli 8 - 40055 Villanova di Castenaso (BO)
Tel +39 051 6032511
www.cimaingranaggi.it
info@cimaingranaggi.it

H

P

M 01.1 - 01.2 - 01.5 - 01.6 - 02.2.5

CISAM - ERNST s.r.l.

CISAM-ERNST SRL

Via Monte Tagliaferro 6 - 21056 Induno Olona (VA)
Tel +39 0332 200216
Fax +39 0332 202623
www.cisam-ernst.com
corporate@cisam-ernst.com

- Durometri / Hardness testers

COBRA

COBRA SRL A SOCIO UNICO

Via Persicetana 24 A/B - 40012 Calderara di Reno (BO)
Tel +39 051 729916
Fax +39 051 729174
www.cobrariduttori.com
info@cobrariduttori.com

H

P

M 02.1.3 - 02.1.6 - 02.1.9 - 02.1.10 - 02.2.1 - 02.2.2



COFLUID SRL

Via Pegomas 12/A-18/A - 52018 Castel San Niccolò (AR)
Tel +39 0575 300209
Fax +39 0575 356207
www.cofluid.it
info@cofluid.it

H 01 - 02 - 03.1 - 04 - 05 - 07 - 10

P

M



COMER SRL

Via G. Rivani 33 - 40138 Bologna (BO)
Tel +39 051 533007
Fax +39 051 6010482
www.comer-italia.com
comer@comer-italia.com

H 01 - 02.1 - 02.2 - 02.3 - 02.4 - 03.1 - 03.3 - 03.4
04.1 - 04.2 - 04.3 - 05 - 06.1 - 06.3 - 06.5 - 06.8
09.1 - 09.2 - 09.3 - 10

P 03.1 - 03.3 - 04 - 05.2 - 05.3 - 06.1 - 06.3 - 06.5
06.6 - 08.1 - 08.2 - 08.3 - 09.1 - 09.2 - 09.3 - 10
12

M



CONFORTI

CONFORTI OLEODINAMICA SRL

Via Boccioni 10 - 20900 Monza (MB)

Tel +39 039 835125

www.confortinet.com

conforti@confortinet.com

p. 112



CONNESSIONI E TENUTE SRL

Via Don Carlo Gnocchi 1/A - 20016 Pero (MI)

Tel +39 02 4531004

Fax +39 02 4565188

www.conten.it

info@conten.it



COSAPPO SRL UNIPERSONALE

Contrada Torre 23 - S.s. 653 Sinnica Km 17+300

85043 Latronico (PZ)

Tel +39 0973 851835/7

Fax +39 0973 851835/7

www.cosappo.it

info@cosappo.it

H 03.1 - 03.3

P

M

H 01 - 02 - 03 - 04 - 05 - 06 - 07 - 09 - 10 - 11

P 03 - 04 - 05 - 06 - 08 - 09 - 10 - 12 - 13

M

H 03.1 - 03.2 - 03.3 - 03.5 - 07.1 - 09.3 - 09.4
09.5 - 09.10

P 03.1 - 03.4 - 09.3 - 09.5 - 09.10

M



CY.PAG. SRL

Via Del Commercio 13 - 23017 Morbegno (SO)

Tel +39 0342 605011

www.cypag.com

sales@cypag.com



D.M.C. DISTRIBUZIONE MERIDIONALE CUSCINETTI SRL

Via E. Gianturco 31/c - 80146 Napoli (NA)

Tel +39 081 7340287

www.dmccuscinetti.it

info@dmccuscinetti.it



D.N.P. INDUSTRIALE SRL

Via B. Buozzi 10 - 20861 Brugherio (MB)

Tel +39 039 877451

www.dnp.it

info@dnp.it

p. 114

H

P 03.1 - 03.4

M

H 09.3

P 09.3

M 03.5 - 04 - 05

H 04.1 - 06.7

P

M



D.R.A. SRL

Via Della Fornace 6 - 10040 Volvera (TO)

Tel +39 011 9853095

www.dra-srl.com

drasrl@drasrl.it

H 01 - 02.1 - 02.2 - 02.4 - 02.5 - 03.1 - 03.2 - 03.3
03.5 - 04 - 05 - 06.1 - 06.2 - 06.3 - 06.5 - 06.6
06.7 - 06.8 - 07 - 09.1 - 09.2 - 09.3 - 10

P

M



DANA GRAZIANO SRL

Via Cumiana 14 - 10098 Rivoli (TO)

Tel +39 011 9570100

www.dana.com

H

P

M 01.1 - 01.2 - 01.6 - 02.2.1 - 02.2.2 - 02.2.5 - 02.2.6
02.2.7 - 03.1.3



DANFOSS POWER SOLUTIONS SRL

Via Rinaldi 111 - 42124 Reggio Emilia (RE)

Tel +39 0522 915511

www.danfoss.com/powersolutions

H 01.1 - 01.3 - 02.1 - 02.3 - 02.5 - 02.10 - 04
07.2 - 07.10

P

M



DANFOSS POWER SOLUTIONS II SRL

Via Matteotti 8 - 20042 Pessano con Bornago (MI)

Tel +39 02 955421

www.danfoss.com/vickersindustrial

H 01.1 - 01.2 - 01.3 - 02.1 - 02.2 - 02.3 - 02.5 - 03.1
04.1 - 04.2 - 04.3 - 04.4 - 05.1 - 05.2 - 06.1 - 06.2
06.3 - 06.4 - 06.5 - 06.7 - 06.8 - 07.1 - 07.2 - 07.3

P

M



DEMAC SRL

Via R. Murri 14 - 20013 Magenta (MI)

Tel +39 02 9784488

Fax +39 02 97003509

www.demac.it

info@demac.it

H 06.1 - 06.4 - 06.10

P

M



**DICEM - UNIVERSITÀ DEGLI STUDI DI CASSINO
E DEL LAZIO MERIDIONALE**

Via G. di Biasio 43 - 03043 Cassino (FR)

Tel +39 0776 2993601

www.unicas.it

- Università / University



DIDIMO ZANETTI SPA

Via Cimabue 13 - 40033 Casalecchio di Reno (BO)

Tel +39 051 6113411

www.zanettispa.com

info@zanettispa.com

H

P

M

01.1 - 01.2 - 01.6 - 01.7 - 02.2.1 - 02.2.2 - 02.2.6
02.2.7



DILANDA SRL A SOCIO UNICO

Via Varesina 178 - 20156 Milano (MI)

Tel +39 02 33400266

Fax +39 02 33402162

www.dilanda.it

info@dilanda.it

H

09.3

P

09.3

M



UNIVERSITÀ DEGLI STUDI
DI MODENA E REGGIO EMILIA

DIEF - UNIVERSITÀ DEGLI STUDI DI MODENA E REGGIO EMILIA

Via Pietro Vivarelli 10 - 41125 Modena (MO)

Tel +39 059 2056111

www.ingmo.unimore.it

- Università / University



DIMEAS - POLITECNICO DI TORINO

Corso Duca degli Abruzzi 24 - 10129 Torino (TO)

Tel +39 011 090102

www.dimeas.polito.it

- Università / University



DIIE - UNIVERSITÀ DEGLI STUDI DELL'AQUILA

Piazzale Ernesto Pontieri - Monteluco Di Roio

67100 Aquila (AQ)

Tel +39 0862 434838

www.diie.univaq.it

- Università / University



DIPARTIMENTO DI INGEGNERIA E ARCHITETTURA UNIVERSITÀ DEGLI STUDI DI PARMA

Parco delle Scienze 181/A - 43124 Parma (PR)

Tel +39 0521 905800

www.dia.unipr.it

- Università / University



**DIPARTIMENTO DI INGEGNERIA INDUSTRIALE
UNIVERSITÀ DEGLI STUDI DI NAPOLI "FEDERICO II"**

Via Claudio 21 - 80125 Napoli (NA)

www.dii.unina.it

dip.ing-industriale@unina.it

- Università / University



**DIPARTIMENTO DI INGEGNERIA INDUSTRIALE
UNIVERSITÀ DI BOLOGNA**

Viale del Risorgimento 2 - 40136 Bologna (BO)

Tel +39 051 2093444

www.ingegneriaindustriale.unibo.it

- Università / University



**DIPARTIMENTO DI MECCANICA
POLITECNICO DI MILANO**

Via La Masa 1 (Campus Bovisa) - 20156 Milano (MI)

Tel +39 02 23991

www.mecc.polimi.it

info-dmec@polimi.it

- Università / University



**UNIVERSITÀ DEGLI STUDI
DI GENOVA**

DITEN - UNIVERSITÀ DEGLI STUDI DI GENOVA

Via all'Opera Pia 11 A - 16145 Genova (GE)

www.diten.unige.it

diten@diten.unige.it

- Università / University



DLM SRL

Via Dei Pioppi 32 - 20073 Opera (MI)

Tel +39 02 57682111

www.dlmtappi.com

info@dlmtappi.com



01.10 - 02.10 - 03.10 - 04.10 - 05.10 - 06.10 - 07.10
09.10 - 10.10



03.10 - 04.10 - 05.10 - 06.10 - 08.10 - 09.10 - 10.10



DMMM - POLITECNICO DI BARI

Via Orabona 4 - 70125 Bari (BA)

Tel +39 080 5963522

www.dmmm.poliba.it

- Università / University



DTG - UNIVERSITÀ DEGLI STUDI DI PADOVA

Stradella S. Nicola 3 - 36100 Vicenza (VI)

Tel +39 0444 998711

www.gest.unipd.it

- Università / University



EFFEGI SYSTEMS SRL

Via 1° Maggio 31 - 25010 Isorella (BS)

Tel +39 030 9958684

Fax +39 030 9952802

www.effegisystems.com

info@effegisystems.com

H 03.1 - 03.2 - 06.2 - 06.4 - 06.5 - 07.1 - 07.2

P

M



a member of **DAIKIN** group

DUPLOMATIC MS SPA

Via Mario Re Depaolini 24 - 20015 Parabiago (MI)

Tel +39 0331 895111

Fax +39 0331 895259

www.duplomaticmotionsolutions.com

vendite.ita@duplomatic.com

H 01.1 - 01.2 - 01.3 - 03.1 - 03.10 - 04 - 05.2 - 06.5
07 - 09.2 - 10.1 - 10.4

P

M 05.11



ELETTROTEC SRL

Via Jean Jaurès 12 - 20125 Milano (MI)

Tel +39 02 28851811

Fax +39 02 28851854

www.elettrotec.com

info@elettrotec.com

H 10.1 - 10.2 - 10.3 - 10.4 - 10.5

P 10.1 - 10.2 - 10.3 - 10.4 - 10.5 - 12

M

p. 116



E.P.P. EURO PRESS PACK SPA

Via Montanaro Disma 87 - 16042 Carasco (GE)

Tel +39 0185 35271

Fax +39 0185 351138

www.europresspack.it

sales@europresspack.it

H 01.2 - 01.3 - 01.4 - 01.5 - 03.1 - 03.2 - 03.5 - 04.1
04.3 - 06.1 - 06.3 - 06.4 - 06.7 - 07.1 - 07.3
09.3 - 10.1 - 10.4 - 11

P

M

p. 118



EMERSON AUTOMATION FLUID CONTROL & PNEUMATICS ITALY SRL

Strada per Cernusco 19 - 20041 Bussero (MI)

Tel +39 02 950371

www.emerson.com/it-it/automation/solenoids-pneumatics

ans@emerson.com

H

P 03 - 04 - 05.3 - 06.1 - 06.3 - 06.4 - 06.5 - 06.6 - 08
09.1 - 09.2 - 10.1 - 10.4 - 10.5 - 12

M 05.6 - 05.10 - 05.11



p. 120

EMMEGI SPA

Via Newton Z.I. 52 - 20062 Cassano d'Adda (MI)

Tel +39 0363 360236

Fax +39 0363 360230

www.emmegi-heat-exchangers.com

info@emmegi-heat-exchangers.com

H 05.3

P

M



EMMEQUATTRO SRL

Via IV Novembre 175/A - 25080 Prevalle (BS)

Tel +39 030 6804211

Fax +39 030 6807049

www.m4ax.it

info@m4ax.it

H

P

M 01.1 - 02.1.2 - 02.1.3 - 02.1.9 - 02.2.1 - 02.2.2
02.2.5 - 02.2.6 - 02.2.7



EMPORIO DEL CUSCINETTO SRL

Viale del Lavoro 32 - 35020 Ponte San Nicolò (PD)

Tel +39 049 8961481

Fax +39 049 8960166

www.emporiodelcuscinetto.it

info@emporiodelcuscinetto.it

H 09.3

P 09.3

M 02.3 - 03.5 - 03.6 - 04 - 05



ENERPAC SPA

Viale Leonardo da Vinci 97 - 20090 Trezzano Sul Naviglio (MI)

Tel +39 02 4861111

www.enerpac.com

enerpac@enerpac.com

H 01.5 - 01.10 - 03.1 - 03.2 - 03.5 - 04.1 - 04.3 - 05.2
05.3 - 06.1 - 06.2 - 06.3 - 06.4 - 06.5 - 06.7 - 07.1
10.1 - 10.2 - 10.3 - 10.4 - 11

P

M



EUROCONIC SRL

Via Diesel Z.I. - 67051 Avezzano (AQ)

Tel +39 0863 509181

Fax +39 0863 509182

www.euroconic.com

info@euroconic.com

H

P

M 03.1.14



p. 122

EUROMAT SRL

Via Vivaldi 151 - 41019 Soliera (MO)

Tel +39 059 567158

Fax +39 059 8577308

www.euromatsrl.eu

info@euromatsrl.eu

H 01.1 - 01.3 - 01.4 - 01.5 - 02.1 - 02.3 - 02.4 - 02.5
04.1 - 04.3 - 07

P

M 02.1.2 - 02.1.6 - 02.1.10 - 02.1.11 - 03.2.3 - 04.1.6
04.3.7 - 04.6.9



EUROSWITCH SPA

Via Provinciale 15 - 25057 Sale Marasino (BS)
Tel +39 030 986549
Fax +39 030 9824202
www.euroswitch.it
info@euroswitch.it

H 10.1 - 10.2 - 10.3 - 10.4 - 10.5

P 10.1 - 10.2 - 10.3 - 10.4 - 10.5 - 12

M



F.LLI GIACOMELLO SRL

Via Magenta 77 cap. 15A - 20017 Rho (MI)
Tel +39 02 9301278
Fax +39 02 9301690
www.fratelligiacomello.it
info@fratelligiacomello.it

H 10.2 - 10.3 - 10.4

P 10.3 - 10.5

M



EVP SYSTEMS SRL

Via delle Calandre 53/a - 50041 Calenzano (FI)
Tel. +39 055 4207514
www.evpsystems.it
info@evpsystems.it

H

P 03 - 04 - 05 - 06 - 08 - 09.1 - 09.2 - 10 - 12

M 05.6 - 05.7 - 05.8 - 05.9 - 05.11



F.LLI TOGNELLA SPA

Via Goito 60 - 21019 Somma Lombardo (VA)
Tel +39 0331 988411
Fax +39 0331 988499
www.tognella.it
tognella@tognella.it

H 04.1 - 04.4 - 04.10 - 05.3 - 10.1 - 10.2 - 10.3 - 10.4

P 04.3 - 10.1 - 10.3 - 10.4

M



F.LLI BONO SPA

Via dell'Economia 131 - 36100 Vicenza (VI)
Tel +39 0444 990990
www.bonofli.it
www.linkedin.com/company/bono-spa
bono@bonofli.it

H 01 - 02 - 03 - 04 - 05 - 06 - 07 - 09 - 10

P 03 - 04 - 05 - 06 - 08 - 09 - 10 - 12 - 13

M 01 - 02.1 - 02.2.1 - 02.2.2 - 02.3 - 03 - 04 - 05.1
05.2 - 05.3 - 05.4 - 05.5 - 05.11 - 05.12 - 05.14 - 05.15

p. 126



F.S.S. F.LLI STARGIOTTI SNC DI STARGIOTTI SIMONE E C.

Via U. Bassi 38 - 47822 Santarcangelo di Romagna (RN)
Tel +39 0541 621322
Fax +39 0541 625886
www.stargiotti.com
info@stargiotti.com

H 01.1 - 02.1 - 02.5 - 03.1 - 03.5 - 04.1 - 04.2 - 04.3
05.2 - 06.1 - 07.1 - 09.3 - 09.4 - 09.5 - 10.1 - 10.2
10.3 - 11

P 03.1 - 03.3 - 03.4 - 04.1 - 04.3 - 04.4 - 05.1 - 06.1
06.3 - 06.4 - 06.6 - 08.1 - 09.1 - 10.1 - 10.2

M 01 - 02 - 03 - 04 - 05



FACCHINETTI SRL

Via degli Abeti 7 - 20064 Gorgonzola (MI)
Tel +39 02 9513205
Fax +39 02 9513442
www.facchinetti.tv
info@facchinetti.tv

H 06 - 10

P 03 - 04 - 06 - 10

M 03.4 - 03.5 - 03.6.1 - 04



FAI FILTRI SRL

Strada Francesca 7 - 24040 Pontirolo Nuovo (BG)
Tel +39 0363 880024
Fax +39 0363 330177
www.faiiltri.it
faifiltri@faifiltri.it

H 05.2 - 05.10

P 08.1 - 08.10 - 12

M

p. 128



FAIZANÈ SPA

Via Monte Pasubio 150 - 36010 Zanè (VI)
Tel +39 0445 318318
Fax +39 0445 318300
www.faizane.com
info@faizane.com

H 04.1 - 04.3 - 06 - 09.2 - 09.3 - 10.1 - 10.3 - 10.5

P 03 - 04 - 05.2 - 05.3 - 06 - 08.1 - 08.2 - 08.3 - 09.2
09.3 - 10 - 12

M 01.1 - 01.2 - 01.4 - 01.5 - 03.5.4 - 03.6.3



FARBO SRL

Via Cimarosa 17 - 40033 Casalecchio di Reno (BO)
Tel +39 051 6419530
Fax +39 051 6419522
www.farbo.it
info@farbo.it

H

P 03.1 - 03.2 - 03.3 - 03.4 - 04.1 - 04.2 - 04.3
04.4 - 05.1 - 05.2 - 06.1 - 06.3 - 06.4 - 08.1
08.2 - 08.3 - 08.4 - 10.1 - 12

M

p. 130



FARO OLEODINAMICA SRL

Via F.lli Bronzetti 37 - 21013 Gallarate (VA)
Tel +39 0331 773777
Fax +39 0331 791076
www.faroolodinamica.com
info@faroolodinamica.com

H 01 - 02 - 03.1 - 04 - 05 - 06 - 07.1 - 07.3 - 07.10
09.1 - 09.2 - 10

P

M



FARO SRL

Via Torino 19 - 29010 Caldasco (PC)
Tel +39 0523 769849
Fax +39 0523 760315
www.faro-bearings.it
sales@faro-spa.it

H

P

M 01.7 - 03.4.4 - 04.1 - 04.3 - 04.4 - 04.5.1 - 04.6.1
04.6.2 - 04.6.7 - 04.6.8 - 04.8

**FASTER SRL**

Via Ludovico Ariosto 7 - 26027 Rivolta D'Adda (CR)
Tel +39 0363 377211
Fax +39 0363 377284
www.fastercouplings.com
info@fastercouplings.com

H 04.1 - 06.7

P

M

**FG-TECH SRL**

Strada nazionale Cisa 83/c - 46029 Suzzara (MN)
Tel +39 0522 978458
www.fg-tech.it
info@fg-tech.it

H 11

P

M

p. 132

**FERRANTI SRL**

Via Alassio 10 - 20156 Milano (MI)
Tel +39 377 5411410
www.ferrantimilano.it
info.ferranti@libero.it

H

P

M 04 - 05.2 - 05.3 - 05.4 - 05.14.3

**FIAR SRL**

Via Moravia 5 - 35030 Selvazzano Dentro (PD)
Tel +39 049 662839
Fax +39 049 8750093
www.fiaroleodinamica.it
info@fiaroleodinamica.it

H 01 - 02 - 03 - 04 - 05 - 06 - 07 - 09 - 10 - 11

P

M

**FESTO SPA**

Via E. Fermi 36/38 - 20057 Assago (MI)
Tel +39 02 457881
www.festo.it
info_it@festo.com

H

P 03 - 04 - 05 - 06 - 08 - 10.1 - 10.4 - 10.5 - 12

M

**FILTREC SPA**

Via Dei Morenghi 1 - 24060 Telgate (BG)
Tel +39 035 8368001
Fax +39 035 831925
www.filtrec.it
info@filtrec.it

H 05.2 - 10.1 - 10.3

P

M

p. 134

**FITCONTASTA SRL**

Via Po 77 - 66020 San Giovanni Teatino (CH)

Tel +39 085 4461250

www.fitcontasta.com

info@fitcontasta.com

H 01 - 02 - 03 - 04 - 05 - 06 - 07 - 09.4 - 09.5 - 10

P 03 - 04 - 05 - 06 - 08 - 10 - 12 - 13

M 01 - 02.1 - 02.3 - 03 - 04.1.5 - 04.2.2 - 04.7
04.9 - 05

**FMI FRANCESCHI SRL**

Strada Baganzola 28/a - 43126 Parma (PR)

Tel +39 0521 992200

www.fmiparma.it

fmi@fmiparma.it

H

P 03 - 04 - 05 - 06 - 08 - 09 - 10 - 13

M 01 - 02.1 - 02.2.2 - 02.3 - 02.4 - 03 - 04 - 05

**FLUCOM SRL**

Via Isacchi 1 - 42124 Reggio Emilia (RE)

Tel +39 0522 303271

Fax +39 0522 306982

www.flucom.it

flucom@flucom.it

H 04

P

M

**FONDERIE MORA GAVARDO SPA**

Via G. Quarena 207 - 25085 Gavardo (BS)

Tel +39 0365 377711

www.fonderiemoragavardo.it

info@fonderiemoragavardo.it

- Fusione ghisa / *Cast iron casting*
- Fusione alluminio / *Aluminium casting*

**FLUID-APP SRL**

Via Garonna 26 - 42124 Reggio Emilia (RE)

Tel +39 0522 1722451

www.fluid-app.it

info@fluid-app.it

H 04.1 - 04.3 - 04.4 - 04.10

P

M

**FORNITURE INDUSTRIALI DELLACASA SRL**

Via Sampierdarena 231 R - 16149 Genova (GE)

Tel +39 010 6459954

www.dellacasa.it

commerciale@dellacasa.it

H

P

M 01 - 02.1 - 02.3 - 03.1 - 03.4 - 03.5 - 03.6
04 - 05.1 - 05.2 - 05.3 - 05.12



FRANCIA SRL

Via Marino Serenari 1/A - 40013 Castel Maggiore (BO)

Tel +39 051 6340068

Fax +39 051 6343021

www.franciacatene.it

info@franciacatene.it

H

P

M

01 - 02.1 - 02.3 - 03.1 - 03.3 - 03.4 - 03.5 - 03.6
04.7 - 05.12 - 05.15



GATES SRL CON SOCIO UNICO

Via Benigno Crespi 19 - MAC4

20159 Milano (MI)

Tel +39 02 66216205

www.gates.com

H

06.1 - 06.2 - 06.3 - 06.4

P

M

03.5.1 - 03.5.3 - 03.5.4



FRIDLE GROUP SRL

Via G. Galilei 53 - 36030 Costabissara (VI)

Tel +39 0444 971856

Fax +39 0444 971846

www.fridle.it

info@fridle.it

H

01.1 - 01.5 - 02.1 - 03.1 - 03.5 - 04 - 05 - 06 - 07.1
07.3 - 09.1 - 09.2 - 09.3 - 10

P

03 - 04 - 06 - 08 - 09.3 - 10

M



GEMELS SPA

Via Giacinto Gambirasio 20/22

24069 Trescore Balneario (BG)

Tel +39 035 940445

www.gemels.it

gemels@gemels.it

H

02.10 - 04.1 - 04.10 - 06.7

P

M



GANDINI SRL

Via Brescia 53 - 25014 Castenedolo (BS)

Tel +39 030 2131109

Fax +39 030 2131149

www.ingranaggigandini.it

info@ingranaggigandini.com

H

P

M

01.1 - 01.3 - 01.4 - 01.5 - 01.6 - 03.1 - 03.1.13
03.3 - 03.3.1 - 03.4 - 03.4.1 - 03.4.2 - 03.4.3



Gear consulting - NVH consulting

GIORGIO BONORI ENGINEERING SRL

Via dei Borgognoni 5 - 40137 Bologna (BO)

Tel + 39 333 5783061

www.giorgiobonori.it

giorgiobonori@giorgiobonori.it

- Software di calcolo e consulenza per trasmissioni
meccaniche (KISSsoft, Transmission 3D) /
*Calculation software and consulting for mechanical
transmission (KISSsoft, Transmission 3D)*

Gleason

GLEASON SALES CORPORATION

Via Gramsci 18 - 20016 Pero (MI)
Tel +39 02 48285724
www.gleason.com

- Macchine Utensili / Machine tools



GRUPPO MECCATRONICO UNINDUSTRIA REGGIO EMILIA

Via Toschi 30/A - 42121 Reggio Emilia (RE)
Tel +39 0522 409764
www.unindustriareggioemilia.it/gruppo-meccatronico
matteo.verona@unindustriareggioemilia.it

- Associazione / Association



GRAZIOLI SRL

Via G.B. Cacciamali 52 - 25125 Brescia (BS)
Tel +39 030 938 8411
www.grazioli.it
info@grazioli.it

H 01 - 02 - 03 - 04 - 05 - 06 - 07 - 09 - 10 - 11

P 03 - 04 - 05 - 06 - 08 - 09 - 10 - 12 - 13

M 01 - 02 - 03 - 04 - 05



GTA LOMBARDIA SRL

Via S. Maria 104 - 20093 Cologno Monzese (MI)
Tel +39 02 27300668
www.gtalombardia.it
info@gtalombardia.it

H 01 - 02 - 03 - 04 - 05 - 06 - 07 - 09 - 10

P

M

p. 138



GRICES HYDRAULIC CYLINDERS SRL

Via Postale Vecchia 111 - 23857 Valgrehentino (LC)
Tel +39 0341 660290
Fax +39 0341 660285
www.grices.it
info@grices.it

H 03.1 - 03.2 - 03.3 - 03.5 - 03.10 - 09.3 - 09.4
09.5 - 09.10 - 10.4

P 03.1

M



GUARNITEC SRL

Via della Repubblica 45 - 20020 Solaro (MI)
Tel +39 02 9690666
Fax +39 02 9691022
www.guarnitecgroup.com
info@guarnitecgroup.com

H 09.3

P 09.3

M



GUMEC SRL

Via del Lavoro 7/a - 40125 Correggio (RE)

Tel + 39 0522 642352

www.gumec.com

gumec@gumec.com

H

04.1 - 04.2 - 04.3 - 04.4 - 04.10

P

M



HANSA-TMP SRL

Via M. L. King 6 - 41122 Modena (MO)

Tel +39 059 415711

Fax +39 059 415730

www.hansatmp.it

hansatmp@hansatmp.it

H

01.1 - 01.3 - 01.5 - 02.1 - 02.3 - 02.4 - 02.5 - 03.2
03.3 - 03.4 - 03.10 - 04.1 - 04.2 - 04.3 - 04.4
05.1 - 05.3 - 07.1 - 10.1

P

M



H.P.S. CENTRO OLEODINAMICO DIVISIONE MOBILE SRL

Via dell'industria 44 Loc. Pezzagrande Zona Ind.Ie

84025 Eboli (SA)

Tel +39 0828 318047/49

www.centroleodinamico.it

info@centroleodinamico.it

H

01 - 02 - 03 - 04 - 05 - 06 - 07 - 09 - 10 - 11

P

03 - 04 - 05 - 06 - 08 - 09 - 10

M



HAWE ITALIANA SRL

Via Cesare Cantù 8 - 20092 Cinisello Balsamo (MI)

Tel +39 02 39975100

Fax +39 02 39975101

info@hawe.it

H

01.1 - 01.3 - 01.4 - 01.5 - 03.1 - 04 - 05.1 - 06.5
06.6 - 07.1 - 10.1

P

M



Deutsche Messe

HANNOVER FAIRS INTERNATIONAL GMBH

Via Paleocapa 1 - 20121 Milano (MI)

Tel +39 02 70633292

www.hftaly.com

info@hftaly.com

- Ente fieristico / Trade fair organizer



HGEARS PADOVA SPA

Via Lussemburgo 25/27 - 35127 Padova (PD)

Tel +39 049 8537301

Fax +39 049 8537589

www.hgears.com

H

P

M

01.1 - 01.2 - 01.5 - 01.6 - 02.1.2 - 02.1.6 - 02.1.8
02.1.9 - 02.1.10 - 02.2.5 - 03.4.3



p. 140

HI-FLEX ITALIA SRL

Via Romena 12 Porrena - 52014 Poppi (AR)

Tel +39 0575 560920

Fax +39 0575 560875

www.hiflexitalia.com

commerciale@hiflexitalia.com

H 01.4 - 01.5 - 03.1 - 03.2 - 03.3 - 03.4 - 03.5 - 04.1 - 04.2
04.3 - 05.2 - 06.1 - 06.2 - 06.3 - 06.4 - 06.7 - 06.8
06.10 - 07.1 - 10.1 - 10.2 - 10.3 - 10.4 - 10.5 - 11

P

M



HOMBERGER SPA

Via dei Laboratori 12 - 20090 Buccinasco (MI)

Tel +39 02 576951

Fax +39 02 57695338

www.homberger.com

info.mc@homberger.com

H

P

M 03.1.2 - 03.1.3 - 03.1.4 - 03.1.8 - 03.1.13 - 03.2.1
03.2.2 - 03.2.3



HV HYDRAULIC SRL

Via dell'Agricoltura 162 - Loc. Castello di Serravalle

40053 Valsamoggia (BO)

Tel +39 051 6705011

Fax +39 051 6705374

www.hvhydraulic.com

info@hvhydraulic.com

H 01.5 - 04.1 - 04.3 - 04.4

P

M



HYDRA HYDRAULICS SRL

Via Aldebaran 1/1A -

56024 San Miniato, Fraz. Ponte a Egola (PI)

Tel +39 0571 1834819

www.hydrailaly.it

vendite@hydrailaly.it

H 04.1 - 04.2 - 04.3 - 04.4 - 05.3 - 07.1 - 07.3 - 10.10

P

M



a member of **DAIKIN** group

HYDRECO HYDRAULICS ITALIA SRL

Via dell'Artigianato 580 - 41058 Vignola (MO)

Tel +39 059 7700411

Fax +39 059 7700425

www.hydreco.com

sales-it@hydreco.com

H 01.1 - 01.5 - 02.1 - 03.1 - 03.2 - 04.1 - 04.2
04.3 - 04.4 - 05.2 - 07.1 - 07.3

P

M 02.1.1 - 02.1.2 - 02.1.3 - 02.1.4 - 02.1.5
02.1.6 - 02.2.6 - 02.3.1

p. 142



HYDRO HOLDING SPA

Via Provinciale Nord 26/a

40050 Castello d'Argile (Bologna)

Tel +39 051 976635

Fax +39 051 976572

www.hydro-holding.com

hhinfo@hydro-holding.com

H 06.1 - 06.2 - 06.03 - 06.4 - 06.7 - 06.8 - 06.10

P

M

**HYDRONIT SRL**

Via Pastrengo 62 - 20814 Varedo (MB)

Tel +39 0362 1841210

Fax +39 0362 1841214

www.hydronit.comsales@hydronit.com

H 01.1 - 01.5 - 02.1 - 04.1 - 04.2 - 04.3 - 04.4 - 05.1
05.2 - 05.3 - 06.5 - 06.8 - 07.1 - 09.1 - 09.2 - 10.1
10.2 - 10.3

P

M



Powered by I.M.M. Hydraulics

I.M.M. HYDRAULICS SPA

Via Italia 49/51 - 66041 Atessa (CH)

Tel +39 0872 889225

Fax +39 0872 889226

www.interpumpfluidsolutions.cominfo@imm-hydraulics.it

H 06.1 - 06.3 - 06.4 - 06.7 - 06.8

P

M

**HYDROTECHNIK ITALIA SRL A SOCIO UNICO**

Via Trento 59 - 21047 Saronno (VA)

Tel +39 02 96708132

Fax +39 02 96369511

www.hydrotechnik.itinfo@hydrotechnik.it

H 05.10 - 06.10 - 10.1 - 10.4 - 10.5 - 10.10

P 06.10 - 10.1 - 10.4 - 10.10

M

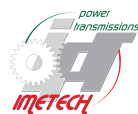
**IMETECH POWER TRANSMISSIONS SRL**

Via delle Pozzette 14 - Loc. Levrini

25080 Soiano del Lago (BS)

Tel +39 0365 500073

www.imetech-pt.cominfo@imetech-pt.com

H

P

M 02.1.1 - 02.1.2 - 02.1.3 - 02.1.4 - 02.1.6 - 02.1.7
02.1.9 - 02.1.10 - 02.1.11 - 02.2.1

**HYDROVEN SRL**

Via G. Matteotti 2 - 36056 Tezze sul Brenta (VI)

Tel +39 0424 539381

Fax +39 0424 89642

www.hydroven.cominfo@hydroven.com

H 01.1 - 01.2 - 01.3 - 01.5 - 02.1 - 02.3 - 02.5
02.10 - 03 - 04 - 05 - 06 - 07 - 09 - 10

P

M

**INDUSTRIAL FORNITURE MORO SNC**

Via Postumia 83 - 31050 Ponzano Veneto (TV)

Tel +39 0422 961811

Fax +39 0422 961830

www.morotreviso.com

H 01 - 02 - 03 - 04 - 05 - 06 - 09 - 10

P 03 - 04 - 05 - 06 - 08 - 09 - 10 - 13

M 01 - 02.1 - 02.2.1 - 02.2.2 - 02.3 - 03 - 04 - 05



INGRANAGGI MOREALI MARIO SPA

Via Carlo Cafiero 16 - 42124 Reggio Emilia (RE)

Tel +39 0522 300641

Fax +39 0522 791065

www.moreali.com

info@moreali.it

H

P

M

01.1 - 01.2 - 01.6



INTERTRACO (ITALIA) SPA

Via Amaldi 1/A, I - 46029 Suzzara (MN)

Tel +39 0376 539711

Fax +39 0376 521722

www.intertraco.it

info@intertraco.it

H

04.1 - 04.3 - 04.4 - 06.1 - 06.3 - 06.4 - 06.7
06.8 - 06.10

P

M



Machine Tools

INNSE-BERARDI SPA

Via Attilio Franchi 20 - 25127 Brescia (BS)

Tel +39 030 3706011

www.innse-berardi.com

info@innse-berardi.com

- Macchine utensili / *Machine tools*



INTERMOT SRL

Via Olanda 51 - 41122 Modena (MO)

Tel +39 059 8396661

Fax +39 059 8396662

www.intermot.com

intermot@intermot.com

H

02.4

P

M



**ISTITUTO DI SCIENZE E TECNOLOGIE PER L'ENERGIA
E LA MOBILITÀ SOSTENIBILI (STEMS - CNR)**

Via Canal Bianco 28 - 44124 Ferrara (FE)

Tel +39 0532 735611

Fax +39 0532 735666

www.stems.cnr.it

responsabile.fe@stems.cnr.it

- Ricerca applicata / *Applied research*



ITALGEAR SRL A SOCIO UNICO

Via Parini 18 - 40033 Casalecchio di Reno (BO)

Tel +39 051 590490

Fax +39 051 6132163

www.italgear.com

info@italgear.com

H

P

M

01.1 - 01.2 - 01.6 - 01.7

KISSsoft

Drivetrain Design Solutions

KISSSOFT AG

Rosengartenstrasse 4 - 8608 Bubikon - Switzerland

Tel +41 55 2542050

www.kisssoft.com

info@kisssoft.com

- Software di calcolo per trasmissioni meccaniche /
Calculation software for mechanical transmission



KONFIT ITALIA SRL A SOCIO UNICO

Via Cagnaghe 10/Q - 25065 Lumezzane (BS)

Tel +39 030 8972167

www.konfit.it

info@konfit.it

H

P

03.4 - 04.4 - 04.10 - 06.1 - 06.3 - 06.4 - 06.5 - 06.6
06.10 - 08.1 - 08.2 - 08.3 - 08.4 - 09.3 - 10.1

M



KLINGELBERG ITALIANA SRL

Via A. Ponchielli 2 - 20063 Cernusco Sul Naviglio (MI)

Tel +39 02 89756700

Fax +39 02 89756703

www.klingelberg.it

info@klingelberg.it

- Macchine utensili: dentatrici, rettificatrici
e macchine di misura / *Machine tools: cutting,
grinding and measuring machines*



LA.RA. DI LACEDRA CATALDO MARCO & CO. SAS

Via degli Elettrocisti 6/8 - 70026 Modugno (BA)

Tel +39 080 9753024

www.laraindustry.com

laraindustry@laraindustry.com

- Consulenza processi produttivi /
Consulting production processes



KNF ITALIA SRL

Via Ungaretti 7 - 20063 Cernusco Sul Naviglio (MI)

Tel +39 02 9290491

www.knf.com

info.it@knf.com

H

01.10

P

05.10

M



LELI SRL

Via Padova 11 - 20127 Milano (MI)

Tel +39 02 26112233

www.lelicuscinetti.it

info@lelicuscinetti.it

H

P

M

03.1.2 - 03.1.7 - 03.5.2 - 03.5.3 - 04 - 05.1.2
05.1.3 - 05.1.4 - 5.15



p. 148

LEONARDO SPA

Sede Legale:

Piazza Monte Grappa 4 - 00195 Roma (RM)

Tel +39 06 324731

Fax +39 06 3208621

www.leonardo.com

H

P

M

01.1 - 01.2 - 01.6 - 01.7 - 02.1.1 - 02.1.2 - 02.1.3
02.1.7 - 02.1.10 - 02.2.7 - 03.1 - 03.3



M.B. ITALIA SRL SOCIO UNICO

Via del Castello 6 - 24030 Mapello (BG)

Tel +39 035 4380296

www.mbitalia.com

commerciale@mbitalia.com

H

06.1 - 06.3 - 06.4 - 06.7 - 06.8

P

M



p. 150

LINK INTERNATIONAL SRL

Via Belvedere 26/28 - 20862 Arcore (MB)

Tel +39 039 2268758

Fax +39 039 2267494

www.linkinternational.it

info@linkinternational.it

H

P

M

01 - 02.1 - 03.1.1 - 03.1.6 - 03.1.7 - 03.1.8 - 03.1.12
03.1.14 - 03.1.15 - 03.3 - 03.4.1 - 03.4.2 - 03.6.1 - 04.1
04.2 - 04.3 - 04.4 - 04.5 - 04.6 - 04.9 - 05.7 - 05.12 - 05.14.3



MAAG ITALY SRL

Viale Romagna 7 - 20089 Rozzano (MI)

Tel +39 02 5759321

www.maag.com

maagitaly@maag.com

H

P

M

01.1 - 04.7 - 04.8 - 04.9



LOPIGOM SPA

Via Rossini 11 - 24060 Credaro (BG)

Tel +39 035 927098

Fax +39 035 929136

www.lopigom.com

info@lopigom.com

H

09.3

P

09.3

M



MAC TUBI SPA

Via Sacca 68 - 43052 Colorno (PR)

Tel +39 0521 525411

Fax +39 0521 525499

www.mactubi.it

info@mactubi.it

H

06.1 - 06.3 - 06.4

P

06.1

M



MAGNA PT SPA

Via dei Ciclamini 4 - 70026 Modugno (BA)
Tel +39 080 5858111
www.magna.com

H

P

M 01.1 - 02.2.5



MAP SERVICE SRL

Via Giuseppe di Vittorio 22 - 25125 Brescia (BS)
Tel +39 030 2680815
www.map-service.it
info@map-service.it

H

P 0.3 - 0.4 - 0.5 - 0.6 - 0.8 - 0.9 - 0.10 - 0.12

M



MARCEGAGLIA CARBON STEEL SPA

Via Marcegaglia 2 - 24040 Boltiere (BG)
Tel +39 035 4197811
www.marcegaglia.com
info.carbonsteel@marcegaglia.com

H 03.2 - 09.4

P 09.4

M



MARZOCCHI POMPE SPA

Via A. Grazia 2 - 40069 Zola Predosa (BO)
Tel +39 051 613 7511
Fax +39 051 592 083
www.marzocchipompe.com
info@marzocchipompe.com

H 01.1 - 02.1

P

M

p. 152



MATRIX SPA

Corso Vercelli 330 - 10015 Ivrea (TO)
Tel +39 0125 615442
Fax +39 0125 615377
www.matrix.to.it
info@matrix.to.it

H

P 04 - 08.2 - 12

M



MCI - MARZORATI COMPONENTI INDUSTRIALI SPA

Via E. Fermi 12 - 20834 Nova Milanese (MB)
Tel +39 0362 364554
www.mci-componenti.it
info@mci-componenti.it

H 09.3

P 09.3

M 01.5 - 03.1.7 - 03.1.8 - 03.1.14 - 03.6 - 04.1 - 04.2
04.3 - 04.4 - 04.5 - 04.7 - 05.2.1 - 05.2.2

**MEBEX SRL**

Via Dossi 30 - 25050 Pian Camuno (BS)

Tel + 39 0364 088055

www.mebex.it

info@mebex.it

H 01 - 02.2 - 02.3 - 02.4 - 02.5 - 03 - 04 - 05.1 - 05.2
05.3 - 06 - 07.1 - 07.2 - 07.3 - 09.2 - 09.3 - 09.4
09.5 - 10 - 11

P 03 - 04 - 05.1 - 05.2 - 05.3 - 06 - 08.1 - 08.2 - 08.3 -
08.4 - 09.2 - 09.3 - 09.4 - 09.5 - 10 - 13

M

**MELUCCI SRL**

Via Emilia 78/80 - 47921 Rimini (RN)

Tel + 39 0541 775768

Fax + 39 0541 778601

www.melucci.it

info@melucci.it

H

P

M 01.1 - 01.2 - 01.4 - 01.5 - 02 - 02.3.3 - 03.1.1
03.1.2 - 03.1.6 - 03.1.7 - 03.1.14 - 03.2.1 - 03.4.1
03.4.3 - 03.4.4 - 03.5 - 03.6 - 04 - 05

**MESSE FRANKFURT ITALIA SRL**

Corso Sempione 68 - 20154 Milano (MI)

Tel +39 02 8807781

www.messefrankfurt.it

info@italy.messefrankfurt.com

- Ente fieristico / Trade fair organizer

**METAL WORK SPA**

Via A. Segni 5/7/9 - 25062 Concesio (BS)

Tel +39 030 218711

Fax +39 030 2180569

www.metalwork.it

metalwork@metalwork.it

p. 156

**METALCASTELLO SPA**

Via Don Forasini 12 - 40030 Castel di Casio (BO)

Tel +39 0534 20511

Fax +39 0534 30409

www.metalcastello.com

customers@metalcastello.com

H

P

M 01.1 - 01.2 - 01.5 - 01.6

**MICROINGRANAGGI SRL**

Via del Commercio 29 - 20090 Buccinasco (MI)

Tel +39 02 48401364

www.microingranaggi.it

info@microingranaggi.it

H

P

M 01.1 - 01.2 - 01.3 - 02.1.1 - 02.1.2 - 02.1.3 - 02.1.4
02.1.5 - 02.1.6 - 03.4.3



MINI TOOLS COATING SRL

Viale dell'industria 50 - 35129 Padova (PD)

Tel +39 049 8079938

Fax +39 049 7808799

www.minitoolscoating.com

info@minitoolscoating.com

- Utensili per ingranaggi conici / *Bevel gear cutting tools*
- Affilature e rivestimenti PVD di utensili per ingranaggi / *Gear tool sharpening and PVD coatings*



Part of Gruppo Mondial

MONDIAL SPA

Via G. Keplero 18 - 20124 MILANO (MI)

Tel +39 02 66810.1

Fax +39 02 66810252

www.mondial.it

mkt@mondial.it

H

P

M

01.4 - 01.5 - 01.6 - 02.1.6 - 02.1.8 - 02.1.10 - 03.1 - 03.3
03.5.2 - 03.6 - 04.1 - 04.2 - 04.3 - 04.4 - 04.5 - 04.6
04.7.3 - 04.8 - 04.9 - 05.1 - 05.2 - 05.3 - 05.5 - 05.6 - 05.7
05.8 - 05.9 - 05.11 - 05.12 - 05.13 - 05.14.3 - 05.15



MISELLI SRL

Via Caduti delle Reggiane 46/48 - 42122 Reggio Emilia (RE)

Tel +39 0522 550291

Fax +39 0522 331140

www.misellisrl.com

info@misellisrl.com

H

03.5 - 04.10 - 05.2 - 06.10 - 09.3 - 10.2 - 10.3
10.10

P

M

p. 158



MITA OLEODINAMICA SPA

Via Carlo Cipolla 12 - 37039 Tregnago (VR)

Tel +39 045 7808900

Fax +39 045 7808162

www.mitaoleodinamica.com

info@mitaoleodinamica.com

H

03.1 - 04.1 - 04.2 - 04.3 - 04.4 - 04.10 - 05.10
06.08

P

M

p. 160



MOOG ITALIANA SRL

Via G. Pastore 4 - 21046 Malnate (VA)

Tel +39 0332 421111

Fax +39 0332 421295

www.moog.it

info.italy@moog.com

H

01.4 - 03.1 - 03.5 - 03.10 - 04.1 - 04.2 - 04.3
04.4 - 07

P

M



MOTOMECCANICA SRL

Via dell'Artigianato 3

37064 Povegliano Veronese (VR)

Tel +39 045 6351900

www.motomeccanica.it

motomeccanica@motomeccanica.it

H

P

M

02.1.2 - 02.1.3 - 02.1.6 - 02.1.7 - 02.1.8 - 02.1.9
02.1.10 - 02.1.11



MOVECO SRL

Via Arturo Biella 19 - 28075 Grignasco (NO)

Tel +39 0163 418128

www.movecosrl.com

info@movecosrl.com

H 03.3 - 04.4 - 07.10

P

M

Net.Fluid[®]

High Quality Components

NET.FLUID SRL

Via Isonzo 40/8 - 20089 Rozzano (MI)

Tel +39 02 90427238

www.net-fluid.com

info@net-fluid.com

H

P 03.1 - 03.3 - 04.1 - 04.3 - 04.4 - 04.10 - 06.3
06.6 - 06.10 - 08.1 - 08.2 - 08.3 - 09.1 - 09.2 - 10.1

M

NACHI

NACHI EUROPE GmbH

NACHI EUROPE GMBH

Bischofstrasse 99 - 47809 Krefeld - Germany

Tel +39 347 8020426

www.nachi.de

info@nachi.de

H 01.1 - 01.2 - 01.3 - 02.3 - 04.1 - 04.2
04.3 - 04.10 - 07.1 - 07.2 - 07.3

P

M 04.1.1 - 04.1.2 - 04.1.3 - 04.1.4 - 04.1.8 - 04.1.10
04.2.1 - 04.2.2 - 04.3.1 - 04.3.2 - 04.3.5 - 04.3.8
04.4 - 04.5.1 - 04.6.10 - 04.7.1 - 04.7.3



NEWTON

Laser Metal Cutting

NEWTON OFFICINE MECCANICHE SRL

Via Gregorcic 32/34 - Z.I. S. Andrea - 34170 Gorizia (GO)

Tel +39 0481 570511

www.newton-srl.it

info@newton-srl.it

- Carpenteria metallica leggera e media / *Metal fabrication*

NET SEALS
The world's best hydraulic seals

NET SEALS SRL

Via Faentina 175/A - 48124 Fornace Zarattini (RA)

Tel +39 0544 502011

Fax +39 0544 502012

www.netseals.it

info@netseals.it

H 01.1 - 01.5 - 02.1 - 02.5 - 03.1 - 03.2 - 04.1 - 04.3
04.4 - 05.1 - 05.2 - 06 - 09.3 - 09.4 - 09.5 - 10.1
10.2 - 10.3 - 10.4

P

M

NGH New Generation Hydraulic

NGH SRL

Z.i. S.s. 106 Bis - 87064 Corigliano - Rossano (CS)

Tel +39 0983 851444

Fax +39 0983 851444

www.nghsrl.it

commerciale@nghsrl.it

H 01.1 - 01.5 - 02.1 - 02.5 - 03 - 04 - 05 - 06 - 07.1
09.3 - 09.4 - 09.5 - 10 - 11

P

M



NORD FLUID SPA

Via Keplero 24 - 20019 Settimo Milanese (MI)

Tel +39 02 33979401

Fax +39 02 38101388

www.nordfluid.it

info@nordfluid.it

H 01.1 - 01.2 - 01.3 - 01.4 - 02 - 04 - 05 - 06 - 07.1
07.3 - 09.2 - 09.3 - 09.5 - 10

P

M



NTN-SNR ITALIA SPA

Via Riccardo Lombardi 19/4 I - 20153 Milano (MI)

Tel +39 02 4799861

Fax +39 02 33500656

www.ntn-snr.com

info-ntnsnritalia@ntn-snr.it

H

P

M 03.1.16 - 04 - 05.1 - 05.2.1 - 05.2.2 - 05.2.3
05.6 - 05.7 - 05.8 - 05.9 - 05.14 - 05.15



NORGREN SRL

Via Roma 108 - 20051 Cassina de' Pecchi (MI)

Tel +39 02 49410696

www.norgren.com

italy@imi-precision.com

H 03.1 - 04.1 - 04.2 - 04.3 - 04.4 - 07.1 - 09.1 - 09.2
10.4

P 03 - 04 - 05.3 - 05.10 - 06.1 - 06.2 - 06.3 - 06.5
06.6 - 08 - 09.1 - 09.2 - 09.3 - 09.10 - 10.1 - 10.3
10.4 - 10.10 - 12

M 02.1.1 - 05.6 - 05.7 - 05.8 - 05.9 - 05.10 - 05.11



NUOVA FIMA STORE SRL

Via Barro 56/58 - 28045 Invorio (NO)

Tel +39 0322 259600

www.nuovafimastore.com

info@nuovafimastore.com

H 04.1 - 04.3 - 04.4 - 04.10 - 10

P 04.1 - 08 - 10

M

p. 162



NR DI NISOLI SRL CON UNICO SOCIO

Via Treviglio 9 - 24053 Brignano Gera d'Adda (BG)

Tel +39 0363 814010

www.nrnisoli.com

nfo@nrnisoli.com

H

P 03.4

M



O.M.F.B. SPA HYDRAULIC COMPONENTS

Via Cave 7/9 - 25050 Provaglio d'Iseo (BS)

Tel +39 030 9830611

Fax +39 030 9839207

www.omfb.com

contatti@omfb.it

H 01.1 - 01.3 - 01.5 - 01.10 - 02.1 - 02.5 - 03.1 - 03.2
03.4 - 04.1 - 04.3 - 04.4 - 05.2 - 05.3 - 06 - 07.1
07.3 - 09.3 - 10.1 - 10.3

P 04.1 - 06.1 - 06.3

M

p. 164



O.M.S. SORDELLA SRL

Via Marconi 129 - 12030 Marene (CN)

Tel +39 0172 742222

www.omssordella.it

info@omssordella.it

H

01.1 - 01.2 - 01.5 - 02.5 - 03.1 - 03.2 - 03.5
04 - 05 - 06 - 07.1 - 07.3 - 09.2 - 09.3 - 09.4
09.5 - 10 - 11

P

M

01-02.1.1-02.1.2-02.1.3-02.1.4-02.1.5-02.1.6-02.1.7-02.1.11
03.1.1-03.1.2-03.1.6-03.1.7-03.1.14-03.4.3-03.6.1-04.1.2
04.1.4-04.1.5-04.1.6-04.1.8-04.6.1-04.6.2-05.1.1-05.1.2



O.T.I. SRL

Via delle Fonti 4/B - 50018 Scandicci (FI)

Tel +39 055 7310192

www.oti-srl.com

info@oti-srl.com

H

P

M

01.1 - 01.6



OCMI-OTG SPA

Via Venezia Giulia 7 - 20157 Milano (MI)

Tel +39 02 3909181

Fax +39 02 3570944

www.ocmigroup.com

info@ocmigroup.com

H

P

M

01.1 - 02.1.1 - 02.1.2 - 02.1.3 - 02.1.6 - 02.1.7
02.1.9 - 02.1.10 - 02.1.11



OFFICINE MECCANICHE CIOCCA SPA

Via Treviglio 44 - 24053 Brignano Gera d'Adda (BG)

Tel +39 0363 815504

Fax +39 0363 815333

www.cioccaspa.it

info@cioccaspa.it

H

04.1 - 04.10 - 06.3 - 06.6 - 06.8

P

M



OILCOMP SRL

Via Barchetta 185/187 - 41123 Modena (MO)

Tel +39 059 330059

Fax +39 059 826828

www.oilcomp.it

info@oilcomp.it

H

04 - 07.3

P

M

p. 166



OILTRONIC DI ALFIERI GIANLUCA

Via Riale 21 - 28053 Castelletto Sopra Ticino (NO)

Tel +39 345 6691370

www.oiltronic.com

galfieri@oiltronic.com

H

07.1 - 07.2 - 07.10

P

M



OLEO MECCANICA INDUSTRIALE COMPONENTI SRL

Via Nenni 2 - 20041 Bussero (MI)
Tel +39 02 95330080/82
Fax +39 02 95330090
www.oleomeccanica.it
info@oleomeccanica.it

H 01.1 - 01.3 - 01.5 - 02.1 - 02.3 - 02.5 - 03.1 - 04.1
04.2 - 04.3 - 04.4 - 05.2 - 05.3 - 07.1 - 07.3 - 10.4
10.5 - 10.10

P

M



OLEODINAMICA GECO SRL

Via Asti 16 - 10044 Pianezza (TO)
Tel +39 011 9671875
Fax +39 011 9672164
www.oleodinamicageco.com
info@oleodinamicageco.com

H 02.3 - 02.5

P

M

p. 168



OLEOBI SRL

Via Don Minzoni 28
40057 Cadriano - Granarolo dell'Emilia (BO)
Tel +39 051 6065111
www.oleobi.it
info@oleobi.it

H 01 - 02 - 03 - 04 - 05 - 06 - 07 - 09 - 10 - 11

P

M



OLEODINAMICA GIANNINI SRLU

Via Arno 13 - 50019 Osmanoro (FI)
Tel +39 055 374691/2/3
www.oleodinamicagiannini.it
sales@oleodinamicagiannini.it

H 01 - 02 - 03 - 04 - 05 - 06 - 07 - 09 - 10

P

M 02.1.6 - 02.1.11 - 02.1.2 - 02.2 - 03.2.3



OLEODINAMICA DELL'AVO SRL

Via Po 26 - 20089 Rozzano (MI)
Tel + 39 02 27208851
www.oleodellavo.it
oleodellavo@hotmail.com

H 01.1 - 01.3 - 01.5 - 03.1 - 03.5 - 04.1 - 04.3 - 05.1
05.2 - 05.3 - 06.1 - 06.3 - 06.6 - 07.1 - 09.3 - 09.4
09.5 - 10.1

P

M

p. 170



OLEODINAMICA MARCHESINI SPA

Via Industriale 36 - 25080 Prevalle (BS)
Tel + 39 030 2629171
www.groupmarchesini.com
info@oleodinamicamarchesini.com

H 04.1 - 04.3 - 04.4

P

M



OLEODINAMICA MARTINALLI SRL
Via Vittorio Veneto 4 - 23010 Rogolo (SO)
Tel +39 0342 685520
Fax +39 0342 685497
www.martinalli.com
info@martinalli.com

H 01 - 02 - 03 - 04 - 05 - 06 - 07 - 09 - 10 - 11

P 03 - 04 - 05 - 06 - 08 - 09 - 10 - 13

M



OLEODINAMICA SEGUINI SRL
Via T. Tasso 2 - 24020 Gorle (BG)
Tel +39 035 656680
Fax +39 035 656686
www.oleodinamicaseguini.it
commerciale@oleodinamicaseguini.it

H 01 - 02 - 03 - 04 - 05 - 06 - 07 - 09 - 10 - 11

P

M



OLEOTEC SRL
Via Varese 19 - 21050 Cantello (VA)
Tel +39 0332 419711
Fax +39 0332 417565
www.oleotec.it
info@oleotec.it

H 04.3 - 06.1 - 06.3 - 06.4 - 06.10 - 10.1

P

M

p. 172



OLEOWEB SRL
Via Ariosto 1 - 42023 Cadelbosco di Sopra (RE)
Tel +39 0522 917679
www.oleoweb.com
sales@oleoweb.com

H 01.5 - 04.1 - 04.3 - 04.4 - 04.10 - 07.3

P

M



OMP OFFICINE MECCANICHE PIEMONTESI SRL
Via Rolando Perino 62/B - 10080 Busano (TO)
Tel +39 0124 477111
Fax +39 0124 477100
www.omp-group.com
info@omp-group.com

H

P

M 01.1 - 01.6 - 01.7 - 03.3

p. 174



OMSI TRASMISSIONI SPA
Via S. Pietro 60 - 25077 Roè Volciano (BS)
Tel +39 0365 563400
www.omsitrasmissioni.com
info@omsitrasmissioni.com

H

P

M 02.1.1 - 02.1.2 - 02.1.3 - 02.1.4 - 02.1.6 - 02.1.9
02.1.10 - 02.1.11 - 02.1.13 - 02.2.1 - 02.2.2 - 02.2.3
02.2.4 - 02.2.6 - 02.2.7 - 02.3.2 - 02.3.4 - 03.1.3 - 03.1.8

p. 176

**OMT GROUP SPA**

Via Lombardia 14 - 24040 Calvenzano (BG)

Tel +39 0363 860311

Fax +39 0363 335620

www.omtgroup.itomtgroup@omtgroup.it

p. 178

**OP SRL**

Via Serpente 97 - 25131 Brescia (BS)

Tel +39 030 3580401

Fax +39 030 3580838

www.op-srl.itinfo@op-srl.it

p. 180

**OPTIBELT ITALIA SRL**

Corso Sempione 221 - 20025 Legnano (MI)

Tel + 39 0331 481020

www.optibelt.cominfo@optibelt.it**H** 04.3 - 04.4 - 04.10 - 05 - 06.3 - 06.5 - 06.6
06.8 - 06.10 - 10.1 - 10.2 - 10.3**P****M****H** 05.10**P****M****H****P****M** 03.4 - 03.5**ORTEA SPA**

Via Dei Chiosi 21 - 20873 Cavenago Brianza (MB)

Tel +39 02 95917800

www.next.ortea.comortea@ortea.com**P SYSTEM AUTOMAZIONE SRL**

Via delle Vigne 166 - 26100 Cremona (CR)

Tel +39 0372 452589

Fax +39 0372 453820

www.psystemsrl.itinfo@psystemsrl.it**H** 04 - 07**P** 04**M****P.I.U. SRL**

Via Caracciolo 13 - 20020 Barbaiana di Lainate (MI)

Tel +39 39 02 93559368

Fax +39 02 93551221

www.piusrl.itinfo@piusrl.it**H** 01 - 02 - 03 - 04 - 05 - 06 - 09 - 10**P** 03 - 04 - 05 - 06 - 08 - 09 - 10 - 12 - 13**M** 01 - 02.1.1 - 02.1.2 - 02.1.3 - 02.1.4 - 02.1.5
02.1.6 - 02.1.7 - 02.1.8 - 02.3 - 03 - 04 - 05*- Energy efficiency*



PARKER HANNIFIN ITALY SRL

Via Caboto 1 - 20094 Corsico (MI)

Tel +39 02 451921

Fax +39 02 4479340

www.parker.com/it

parker.italy@parker.com

H 01.1 - 01.2 - 01.3 - 01.4 - 01.5 - 02.1 - 02.2 - 02.3 - 02.4 - 02.5 - 03.1
03.2 - 03.3 - 03.5 - 04 - 05.1 - 05.2 - 06.1 - 06.2 - 06.3 - 06.4 - 06.5
06.7 - 06.8 - 07.1 - 07.2 - 07.3 - 09.3 - 10.1 - 10.2 - 10.3 - 10.4 - 10.5

P 03.1 - 03.2 - 03.3 - 03.4 - 04.1 - 04.2 - 04.3 - 04.4 - 05.1 - 05.3
06.1 - 06.2 - 06.3 - 06.4 - 06.6 - 08 - 09.2 - 09.3 - 10.1 - 10.2
10.4 - 10.5 - 12

M



PASELLO TRATTAMENTI TERMICI SRL

Via Torretta 39/A - 40012 Calderara Di Reno (BO)

Tel +39 051 728778

Fax +39 051 728851

www.pasello.com

info@pasello.com

- Trattamenti termici / Heat treatments



PEEN SERVICE SRL

Via Pollastri 7 - 40138 Bologna (BO)

Tel +39 051 533550

Fax +39 051 531307

www.peenservice.it

info@peenservice.it

- Trattamenti dei metalli / Metal treatments



PIOTTI OLEODINAMICA SRL

Via V. Veneto 3 - 21041 Albizzate (VA)

Tel +39 0331 993147

www.piottioleodinamica.it

piotti@piottioleodinamica.it

H 04.1 - 04.3 - 04.4 - 04.10 - 06.7 - 06.10 - 10.1

P

M



PNEUMAX SPA

Via Cascina Barbellina 10 - 24050 Lurano (BG)

Tel +39 035 4192777

Fax +39 035 4192740/1

www.pneumaxspa.com

info@pneumaxspa.com

H

P 03 - 04 - 05.2 - 05.3 - 05.10 - 06.3 - 06.4 - 06.6
06.10 - 08 - 09.1 - 09.2 - 10.1 - 10.4 - 10.10 - 12

M



PRECMAR SRL

Via Aldo Moro 7 - 84081 Baronissi (SA)

Tel +39 089 878431

www.precmar.com

info@precmar.com

H 02 - 03 - 04 - 10

P 03 - 04 - 06 - 08 - 10 - 12

M



p. 188

PROMATEC SPA

Via Per Castelletto 3/5 - 20080 Albairate (MI)
Tel +39 02 9469801
www.promatec.it
info@promatec.it

H 01.3 - 01.4 - 02.4 - 04.1 - 05.10 - 06.1 - 06.2
06.3 - 06.4 - 06.7 - 06.8 - 06.10

P 06.1 - 06.3 - 06.4 - 06.6 - 06.10 - 08.1 - 12

M



QUINZANI SRL

Via Volta 21/D - 25010 San Zeno Naviglio (BS)
Tel +39 030 3539370
Fax +39 030 3539375
www.quinzani.it
info@quinzani.it

H

P

M 01 - 03.1 - 03.4 - 03.5 - 03.6 - 04 - 05.1 - 05.2 - 05.3
05.4 - 05.5 - 05.6 - 05.7 - 05.8 - 05.9 - 05.10 - 05.15



p. 26

PUBLITEC SRL

Via Passo Pordoi 10 - 20139 Milano (MI)
Tel +39 02 535781
www.publiteconline.it
info@publitech.it

- Editoria / Publishing



R. GAROTTI & FIGLIO SRL

Via Dè Brozzi 19/21 - 48022 Lugo (RA)
Tel +39 0545 22205
Fax +39 0545 23050
www.garotti.com
info@garotti.com

H 01.1 - 01.5 - 02.1 - 02.5 - 04.1 - 04.3 - 05.2 - 05.3
06.1 - 06.2 - 06.3 - 06.4 - 06.6 - 06.7 - 06.8
9.3 - 10.1 - 10.4 - 10.5 - 11

P 03 - 04 - 05.1 - 05.3 - 06.1 - 06.3 - 06.4 - 06.5
06.6 - 08 - 09.2 - 09.3 - 10.1 - 10.2 - 10.4 - 10.5
12 - 13

M 01 - 02.1 - 02.2.1 - 02.3.1 - 02.3.3 - 03.1 - 03.3
03.4 - 03.5 - 03.6 - 04 - 05.1 - 05.2.1 - 05.2.2
5.12 - 05.14.3



QUINE BUSINESS PUBLISHER

Via Spadolini 7 - 20141 Milano (MI)
Tel +39 02 88184400
www.media.quine.it
l.rossi@lswr.it

- Editoria / Publishing



RACCORDTUBI SRL

Via Misano 6 - 24040 Calvenzano (BG)
Tel +39 0363 86249
www.raccordtubi.it
info@raccordtubi.it

H 06.3 - 06.4

P

M



RICAMBI BARSÌ SAS

Via Epitaffio 58 - 04100 Latina (LT)

Tel + 39 0773 692692

Fax + 39 0773 697022

www.ricambibarsi.it

vendite@ricambibarsi.it

H

P

03 - 04 - 05 - 06 - 08 - 09.3 - 10 - 12 - 13

M

01 - 02.1 - 02.3 - 03.1 - 03.2 - 03.3 - 03.4 - 03.5
03.6 - 04 - 05



RP SANTINI SRL

Via Mario Fantelli 6/A - 43122 Parma (PR)

Tel +39 0521 272823

Fax +39 0521 270846

www.rpsantini.com

vendite@rpsantini.com

H

06.3 - 06.10

P

M



RONZIO OLEODINAMICA SPA

Viale Industria 37/39 - 20010 Boffalora Sopra Ticino (MI)

Tel +39 02 9754057

Fax +39 02 97255070

www.ronzio.com

sales@ronzio.com

H

01.1 - 02.1 - 02.10 - 05.2 - 06.6

P

M

p. 190



ROSSI SPA

Via Emilia Ovest 915/A - 41123 Modena (MO)

Tel + 39 059 330288

www.rossi.com

info@rossi.com

H

P

M

02.1.1 - 02.1.2 - 02.1.3 - 02.1.4 - 02.1.5
02.1.6 - 02.1.7 - 02.1.8



RUBINETTERIA PARMENSE

DI SANTINI SERGIO & C. SNC

Via Mario Fantelli 6/A - 43122 Parma (PR)

Tel +39 0521 272823

Fax +39 0521 270846

www.rubinetteriaparmense.com

info@rubinetteriaparmense.com

H

01.5 - 06.3 - 06.10 - 09.10

P

M



RUBIX SPA

Via Canovine 14 - 24126 Bergamo (BG)

Tel +39 035 327111

it.rubix.com

it.marketing@rubix.com

H

01 - 02 - 03 - 04 - 05 - 06 - 07 - 09 - 10 - 11

P

03 - 04 - 05 - 06 - 08 - 09 - 10 - 12 - 13

M

01 - 02 - 03 - 04 - 05

**RUDIFLEX SRL**

Via Madonnina 110 - 25018 Montichiari (BS)

Tel +39 030 9650406

Fax +39 030 9664288

www.rudiflex.it

info@rudiflex.it

H 01 - 02 - 03 - 04 - 05 - 06 - 07 - 09 - 10

P 03.1 - 03.2 - 03.4 - 06.1 - 06.2 - 06.3

M

**S.I.A.O. SRL****SOCIETÀ ITALIANA APPLICAZIONI OLEODINAMICHE**

Via dell'Acqua 9 - 20027 Rescaldina (MI)

Tel +39 0331 465025

Fax +39 0331 465029

www.siaosrl.it

info@siao.it

H 01 - 02.1 - 02.2 - 03.1 - 03.2 - 03.5 - 04 - 05
06 - 07.1 - 07.3 - 09.3 - 09.4 - 09.5 - 10

P

M

**SAE FLEX SPA**

Via Tito Speri 19 - 25040 Nigoline di Cortefranca (BS)

Tel +39 030 9828335

Fax +39 030 9828350

www.saefflex.it

info@saefflex.it

H 01 - 02 - 03 - 04 - 05 - 06 - 07 - 10

P

M

**SAF SRL**

Via Dante 79/D - 22070 Carbonate (CO)

Tel +39 0331 837315

Fax +39 0331 834499

www.safsinter.it

info@safsinter.it

H 05.10 - 06.10

P 03.3 - 03.4 - 04.1 - 04.3 - 04.4 - 06.1 - 06.3
06.5 - 06.6 - 06.10 - 08.1 - 08.3

M

**SAI SPA**

Via Olanda 51 - 41122 Modena (MO)

Tel +39 059 420111

Fax +39 059 451260

www.saihydraulics.com

saispa@saispa.it

H 02.4

P

M

**SAIP SRL**

Via Lambro 23 - 20073 Opera (MI)

Tel +39 02 57603913

Fax +39 02 57604752

www.saip.it

saip@saip.it

H 05.1

P

M

p. 192



SALAMI SPA SOCIETÀ CON UNICO SOCIO

Via Emilia Ovest 1006 - 41123 Modena (MO)

Tel +39 059 387411

Fax +39 059 387639

www.salami.it

sales@salami.it

p. 194

SCHAEFFLER

SCHAEFFLER ITALIA SRL

Via Dr. Georg Schaeffler 7 - 28015 Momo (NO)

Tel +39 0321 929211

www.schaeffler.it

info.it@schaeffler.com

p. 196

SCHAEFFLER

SCHAEFFLER WATER PUMP BEARING ITALIA SRL

Via Dr. G. Schaeffler 7 - 28015 Momo (NO)

Tel + 39 0321 928511

www.schaeffler.it

infowpb.it@schaeffler.com

H 01.1 - 02.1 - 04.1 - 04.2

P

M

H

P

M 04 - fino a 04.9.2 - 05.1 - 05.2 - 05.2.2 - 05.2.3
05.2.4 - 05.2.5 - 05.3 - 05.4 - 05.5 - 05.6 - 05.7
05.8 - 05.9 - 05.15

H

P

M 04.1.10



SECO TOOLS ITALIA SPA A SOCIO UNICO

Via Roma 2 - 22070 Guanzate (CO)

Tel +39 031 978111

www.secotools.com

it.marketing@secotools.com



SERTO ITALIANA SRL

Via Lesina 13 - 24030 Brembate di Sopra (BG)

Tel +39 035 333000

www.serto.it

info-it@serto.com



SESINO COSTANTE SPA

Via Monza 150 - 20060 Gessate (MI)

Tel +39 02 95380334

Fax +39 02 95780528

www.sesino.com

info@sesino.com

- Utensili per asportazione di truciolo, creatori e
coltelli ad inserti, Power Skiving / Metal Cutting Tools,
Indexable Hobs and Shapers, Power Skiving

H 04.1 - 04.3 - 04.10 - 06.1 - 06.2 - 06.3
06.4 - 06.7 - 06.10

P 04.1 - 04.3 - 04.10 - 06.1 - 06.2 - 06.3
06.6 - 06.10

M

H 05.3

P

M

**SGM SRL**

Viale Gian Battista Stucchi 66/4 - 20900 Monza (MB)

Tel +39 039 836246

www.new-tem.com/itsgm@new-tem.com

- Macchinari per la sbavatura termica e disossidatrici /
Thermal Deburring Machinery and deoxidizers

Sumitomo Drive Technologies[®]

SM-Cyclo Italy Srl

SM - CYCLO ITALY SRL

Via dell'Artigianato 23 - 20007 Cornaredo (MI)

Tel +39 02 93481101

www.sumitomodrive.comSM_IT.customerservice@shi-g.com

H

P

M

02.1.1 - 02.1.2 - 02.1.3 - 02.1.4 - 02.1.5 - 02.1.7
02.1.8 - 02.1.10**SISTEM PNEUMATICA SRL**

Via della Salute 85/10 BCD - 40132 Bologna (BO)

Tel +39 051 4144811

Fax +39 051 406158

www.sistemp.cominfo@sistemp.com

H

P

04.3 - 04.10 - 06.1 - 06.3 - 06.4 - 06.6 - 06.10 - 12

M

**SMART PROTECTIONS SRL**

Via Montorfano 66 - 22032 Albese con Cassano (CO)

Tel +39 031 622602

www.smartprotections.comsales@smartprotections.com

H

06.10

P

06.1

M

**SKF INDUSTRIE SPA**

Via Pinerolo 54 - 10060 Airasca (TO)

Tel + 39 011 98521

www.skf.com

H

P

M

04

p. 200

**SMC ITALIA SPA**

Via delle Donne Lavoratrici 21 - 20861 Brugherio (MB)

Tel +39 039 90691

Fax +39 039 9069361

www.smcitalia.itmailbox@smcitalia.it

p. 202

H

P

03 - 04 - 05.2 - 05.3 - 06 - 08 - 09.3 - 10 - 12 - 13

M

05.6 - 05.7 - 05.10 - 05.11



SOBA ENGINEERING SRLS

Via M. D'azeglio 21 - 40123 Bologna (BO)
Tel + 39 0532 202322
sobaengineering@gmail.com

- Consulenza / Consulting



SOMASCHINI SPA

Via Nazionale 37 - 24069 Trescore Balneario (BG)
Tel +39 035 4256811
www.somaschini.com
info@somaschini.com

H

P

M 01.1 - 01.2 - 01.6 - 01.7



SOGEAC SRL

Via Piave snc - 27020 Scaldasole (PV)
Tel +39 0382 997863
www.sogeac.it
info@sogeac.it

H

P 03 - 04 - 05 - 06 - 08 - 09.1 - 09.2 - 09.3 - 10.1
10.3 - 10.4 - 12 - 13

M

p. 206



SOMASCHINI AUTOMOTIVE SRL

Via Enrico Mattei 42 - 24060 Entratico (BG)
Tel +39 035 942853
www.somaschini.com
info@somaschini.com

H

P

M 01.1



SOMI SRL

Via Giotto 8 - 39100 Bolzano (BZ)
Tel +39 0471 542400
www.somi.it
info@somi.it

H 01 - 02.1 - 02.3 - 02.4 - 02.5 - 03 - 04 - 05 - 06
07 - 09 - 10 - 11

P 03 - 04 - 05 - 06 - 08 - 09 - 10.1 - 10.4 - 10.5 - 12

M



STAUFF ITALIA SRL

Via Como 9 - I 23846 Garbagnate Monastero (LC)
Tel +39 031 658494
Fax +39 031 655005
www.stauff.com
sales@stauff.it

H 04.1 - 04.3 - 04.4 - 05.1 - 05.2 - 06.1 - 06.2 - 06.3
06.4 - 06.7 - 06.8 - 06.10 - 07.3 - 10.1 - 10.2 - 10.3
10.4 - 10.5

P

M

p. 208



STIMA SPA

Via Giudei 33/35 - 40050 Funo di Argelato (BO)

Tel +39 051 8651511

Fax +39 051 860263

www.stima.it

group@stima.it

H 04.1 - 05.1 - 05.2 - 06.2 - 06.3 - 06.7 - 10

P 03 - 04 - 05 - 06 - 08 - 09.2 - 10 - 12 - 13

M



STRUMENTAZIONE INDUSTRIALE SRL

Via Barro 56/58 - 28045 Invorio (NO)

Tel +39 0322 259233

Fax +39 0322 259488

www.strumentazione.com

info@strumentazione.com

H 04.1 - 04.3 - 04.4 - 04.10 - 10

P 04.1 - 04.3 - 08 - 10

M



STUCCHI SPA

Via della Lira Italiana 397 - 24040 Pagazzano (BG)

Tel +39 0363 380100

Fax +39 0363 380171

www.stucchigroup.com

info@stucchigroup.com

H 04.1 - 06.7

P

M



STUDIO TECNICO TURCI

Via Casetti 35 - 47521 Cesena (FC)

Tel +39 338 5480943

Fax +39 0363 380171

www.turci.biz

info@turci.biz

- Consulenza / Consulting



SYSTEM FLUID SRL

Via Leonardo Da Vinci 26/A - 24062 Costa Volpino (BG)

Tel +39 035 970438

www.systemfluid.it

info@systemfluid.it

H 06.2 - 07.1 - 11

P 06.2

M



TAU SERVICE SRL

Via A. Volta 64 - 21020 Cardano Al Campo (VA)

Tel + 39 0331 776861

www.tausrl.it

info@tausrl.it

H 01 - 02 - 03 - 04 - 05 - 06 - 07 - 09

P 03 - 04 - 05 - 06 - 08 - 09 - 10 - 12 - 13

M 01 - 02.1 - 02.3 - 03 - 04 - 05

p. 210

p. 212



TD MOUNTINGS SRL

Via Leonardo da Vinci 146 - 24043 Caravaggio (BG)

Tel +39 0363 222567

Fax +39 0363 222567

www.tdmountings.it

info@tdmountings.it

H

P 03.4

M

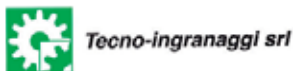

TECNO-INGRANAGGI SRL

Via Industriale 127 - 25020 Capriano del Colle (BS)

Tel +39 030 9971909

Fax +39 030 9971614

www.tecnoingranaggi.com

info@tecnoingranaggi.com

H

P

M 01.1 - 01.6 - 03.4.1 - 03.4.3



TECNICHE NUOVE MEDIA SPA

Via Eritrea 21 - 20157 Milano (MI)

Tel +39 02 390901

www.tecnichenuove.com

- Editoria / Publishing



TECNOEMME SRL

Via Emilia 3 - 24052 Azzano San Paolo (BG)

Tel +39 035 686268

Fax +39 035 683936

www.tecnoemmesrl.it

info@tecnoemmesrl.it

H

P 03 - 04 - 05.2 - 05.3 - 06 - 08 - 09.2 - 10.1 - 10.3
10.4 - 12

M



TEKNO UNO SRL

Via F.lli Cervi 11 - 37036 San Martino Buon Albergo (VR)

Tel +39 045 8780400

Fax +39 045 8780394

www.teknouni.it

info@teknouno.it

H 05.2 - 07.1 - 07.2 - 10.1 - 10.2 - 10.3 - 10.4 - 10.5

P 03 - 04 - 05.1 - 05.2 - 05.3 - 06.1 - 06.3 - 06.4
06.5 - 06.6 - 08 - 09.1 - 09.2 - 10.1 - 10.2 - 10.3
10.4 - 10.5 - 12 - 13

M



TIERRE GROUP SPA

Via dell'Industria 18 - 20032 Cormano (MI)

Tel +39 02 6630881

Fax +39 02 66304172

www.tierregroup.com

info@tierregroup.com

H

P 04.3 - 04.4 - 06 - 10.1

M



TIMGLOBAL MEDIA SRL A SOCIO UNICO

Via S. Bovio 3 - 20054 Segrate (MI)

Tel +39 02 7030631

www.tim-europe.com

info@tim-europe.com

- Editoria / Publishing

TIMKEN

TIMKEN ITALIA SRL

Viale Forlanini 23 - 20134 Milano (MI)

Tel +39 02 5300971

Fax +39 02 53009799

www.timken.com

H

P

M 03.1 - 03.5 - 03.6 - 04.1 - 04.2 - 04.3 - 04.4
04.5 - 04.7 - 05.2



TITAN ENGINEERING SPA

Via Dei Cerri 16 (Loc. Ciarulla)

47899 Serravalle (Repubblica di San Marino)

Tel +39 0549 960419

Fax +39 0549 960421

www.titanengineering.sm

info@titanengineering.sm

H

P

04.3 - 04.4 - 05.3 - 06.1 - 06.3 - 06.6 - 10.1

M



TOR-MEC SRL

Viale Cooperazione 27 - 45100 Borsea (RO)

Tel +39 0425 476602

Fax +39 0425 476022

www.tor-mec.it

padoan@tor-mec.it

H 06.3 - 06.8

P

M



TOSONI FLUIDODINAMICA SPA

Via F.lli Cervi 20 - 25030 Roncadelle (BS)

Tel +39 030 2584777

Fax +39 030 2582212

www.tosoni.it

info@tosoni.it

H 01 - 02 - 03 - 04 - 05 - 06 - 07 - 09 - 10 - 11

P 03 - 04 - 05 - 06 - 08 - 09 - 10 - 12 - 13

M

p. 216



TRACEPARTS SRL

Via Aristotele 109 - 42122 Reggio Emilia (RE)

Tel + 39 0522 391727

www.traceparts.com

info@traceparts.it

- Software / Software

p. 214

p. 218

**UFI FILTERS HYDRAULICS SPA**

Via S. Chierico 24 - 24060 Bolgare (BG)

Tel +39 035 4493811

Fax +39 035 843743

www.ufihyd.cominfo.ufihyd@it.ufifilters.com

p. 222

**UNIGASKET SRL**

Via Lombardia 16 - 24060 Villongo (BG)

Tel +39 035 925032

Fax +39 035 935414

www.unigasket.itcommerciale@unigasket.it**UNILAB LABORATORI INDUSTRIALI SRL**

Via Umbria 22 - 35043 Monselice (PD)

Tel +39 0429 781280

Fax +39 0429 784527

www.unilab.itcommerciale@unilab.it**H** 05.2 - 10.1 - 10.3**P****M****H** 06.1 - 06.3 - 06.4 - 09.3**P** 06.1 - 06.2 - 09.3**M**

- Laboratorio prove / Test laboratory

**UTENSILDODI SRL**

Via G. Boselli 10 - 29015 Castel San Giovanni (PC)

Tel +39 0523 881747

Fax +39 0523 882197

www.utensildodi.cominfo@dodisnc.com

p. 224

**VARVEL SPA**

Via 2 Agosto 1980 9 - 40056 Valsamoggia (BO)

Tel +39 051 6721811

Fax +39 051 6721825

www.varvel.comvarvel@varvel.com**VENETA BEARINGS SRL**

Via Torino 15 - 35035 Mestrino (PD)

Tel +39 049 9001944

Fax +39 049 9001543

www.venetabearings.itinfo@venetabearings.it**H** 03.1 - 04.1 - 06.1 - 06.2 - 06.3 - 06.4 - 06.7 - 09.3
09.5 - 10.1 - 10.3 - 11**P** 03.1 - 03.4 - 04.1 - 04.3 - 04.4 - 05.2 - 05.3 - 06.1
06.3 - 06.4 - 06.5 - 06.6 - 0.8 - 09.1 - 09.3 - 09.5
10.1 - 10.2 - 10.3 - 10.4 - 13**M** 01.1 - 01.3 - 01.4 - 01.5 - 03.1.7 - 03.1.11 - 03.1.14
03.4.1 - 03.4.3 - 03.5 - 03.6 - 04 - 05.1 - 05.2**H****P****M** 02.1.1 - 02.1.2 - 02.1.3 - 02.1.4 - 02.1.6 - 02.1.8
02.1.10 - 02.1.13**H****P****M** 01 - 02.1 - 02.3.1 - 02.4 - 03 - 04 - 05



VESTA AUTOMATION SRL

Via Martiri di Belfiore 69/A - 45100 Rovigo (RO)

Tel +39 0425 474838

Fax +39 0425 474670

www.vesta.it

info@vesta.it

H

P 03 - 04 - 05.3 - 06.1 - 06.3 - 06.4 - 06.5 - 08 - 09
10.1 - 10.4

M



VUOTOTECNICA SRL

Via Como 146/A - 23883 Beverate di Brivio (LC)

Tel +39 039 5320561/106

Fax +39 039 5320015

www.vuototecnica.net

info@vuototecnica.net

H

P 12

M

p. 228

VERZOLLA

VERZOLLA SRL

Via Brembo 13/15 - 20900 Monza (MB)

Tel +39 039 21661

Fax +39 039 2103010

www.verzolla.com

verzolla@verzolla.com

H

01 - 02 - 03 - 04 - 05 - 06 - 07 - 09 - 10 - 11

P

03 - 04 - 05 - 06 - 08 - 09.1 - 09.2 - 09.3
09.5 - 10 - 12 - 13

M

01 - 02.1 - 02.3 - 03.2 - 03.3 - 03.4
03.5 - 03.6 - 04 - 05

p. 226



VIVOIL OLEODINAMICA VIVOLO SRL

Via Leone Ginzburg 2/4 - 40054 Cento di Budrio (BO)

Tel +39 051 803689

Fax +39 051 800061

www.vivoil.com

info@vivoil.com

H

01.1 - 02.1 - 02.10

P

M

p. 230



WAIRCOM MBS SPA

Via Piemonte 13/15 - 20070 Vizzolo Predabissi (MI)

Tel +39 02 98230801/21

Fax +39 02 98230830

www.waircom-mbs.com

info@waircom-mbs.com

H

P 03 - 04.1 - 04.3 - 04.4 - 04.10 - 06.1 - 06.3
06.4 - 06.6 - 08 - 09.1 - 09.2 - 09.3 - 09.4
09.5 - 10.1 - 12

M



WALVOIL SPA

Via Adige 13/D - 42124 Reggio Emilia (RE)

Tel +39 0522 932411

Fax +39 0522 300984

www.walvoil.com

info@walvoil.com

H

01 - 02 - 04

P

M

p. 232



WERMA ITALIA SRL

Via Dell'Artigianato 42 - 29122 Piacenza (PC)

Tel + 39 0523 044544

www.werma.com/it

info@werma.it



THERMOPLASTIC TUBING AND HOSES

ZEC SPA

Strada Lungolorno 11 - 43052 Colorno (PR)

Tel +39 0521 816631

Fax +39 0521 816772

www.zecspa.com

info@zecspa.com

p. 234

H 06.1 - 06.3

- Segnaletica acustica e luminosa / *Acoustic and light signals*

P 06.1

M

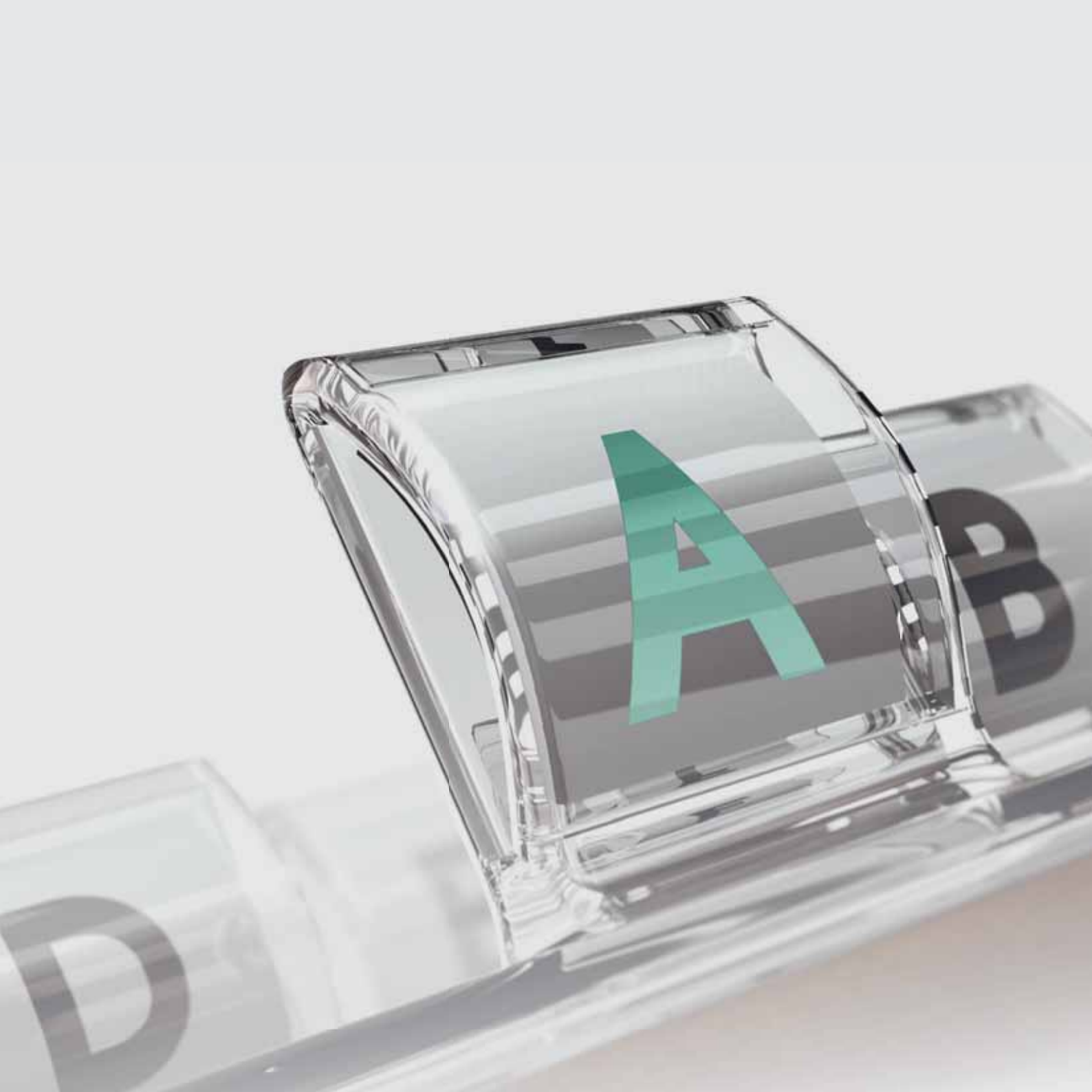

SCHEDE ASSOCIATI
MEMBERS' PRESENTATION



**A.P.I. SRL**

Via Cornaggia 107 - 22076 Mozzate (CO)
Tel +39 0331 823511 - Fax +39 0331 823480
www.api-pneumatic.com
info@api-pneumatic.com

PRESIDENTE | GENERAL MANAGER:

Emanuela Doddi

**FATTURATO | TURNOVER:**

Euro 11.600.000,00

**DIPENDENTI | EMPLOYEES:**

50

**ALTRE INFORMAZIONI | OTHER INFORMATION**

Azienda fondata nel 1987 e specializzata nella progettazione e nella produzione di componenti per l'automazione pneumatica industriale.

Company founded in 1987 and specialized in the design and in the production of components for the industrial pneumatic automation.

PRODOTTI | PRODUCTS

Cilindri a norme ISO, CNOMO e UNITOP, tondi, corsa breve, senza stelo, compatti e guidati, a cartuccia, mani di presa, unità di guida. Attuatori rotanti. Cilindri Inox.

Valvole a connessione multipolare, valvole ed elettrovalvole in linea, ISO, NAMUR. Valvole accessorie, scarico rapido, corsoio, sfera, unidirezionali. Circuiti integrati. Valvole Inox.

Gruppi trattamento aria, manometri, serbatoi, raccordi, tubi, accessori. Componenti Inox.

Cylinders according to ISO, CNOMO and UNITOP standard, round, short stroke, compact, guided, cartridge, grippers, slide units.

Rotary actuators. Stainless Steel cylinders.

Multipolar connections valves, pneumatic and solenoid valves, in-line, ISO, NAMUR. Ancillary valves, quick exhaust, slide, ball and unidirectional. Stainless Steel valves.

Airline equipment, pressure gauges, air reservoirs, silencers, fittings, tubings, accessories. Stainless Steel components.



➤ Cilindri ISO 15552, alesaggi 32 ÷ 320.
ISO 15552 Cylinders, bores 32 ÷ 320.



➤ Valvole ed elettrovalvole da 1/8" a 1/2".
Valves and solenoid valves from 1/8" to 1/2".



➤ Cilindri Inox ISO 15552, alesaggi 32 ÷ 200.
ISO 15552 Stainless Steel Cylinders, bores 32 ÷ 200.



➤ Cilindri Compatti ISO 21287, alesaggi 16 ÷ 125.
ISO 21287 Compact Cylinders, bores 16 ÷ 125.



➤ Elettrovalvole a connessione multipolare, 1/4".
Multipole connection solenoid valves, 1/4".



➤ Cilindri Tondi Inox, alesaggi 16 ÷ 63.
Stainless Steel Round Cylinders, bores 16 ÷ 63.



H

P

M

**AIGNEP SPA**

Via Don G. Bazzoli 34 - 25070 Bione (BS)
Tel +39 0365 896626 - Fax +39 0365 896561
www.aignep.com
aignep.it@aignep.com

PRESIDENTE | GENERAL MANAGER:

Graziano Bugatti

**FATTURATO | TURNOVER:**

Euro 82.000.000,00

**DIPENDENTI | EMPLOYEES:**

280

**ALTRE INFORMAZIONI | OTHER INFORMATION**

Aignep esporta in oltre 100 Paesi nel mondo grazie a una rete capillare di distributori e a 10 filiali dislocate in USA, Spagna, Svizzera, Brasile, Francia, Colombia, Cina, Russia, Germania e Messico.

Aignep exports in more than 100 countries thanks to an intensive distribution network and thanks to 10 branches located in USA, Spain, Switzerland, Brazil, France, Colombia, China, Russia, Germany and Mexico.

Filiali estere | Foreign branches:

AIGNEP USA LLC - AIGNEP IBERICA SA
AIGNEP AG - AIGNEP DO BRASIL COMERCIO DE COMPONENTES PARA AUTOMAÇÃO LTDA - AIGNEP FRANCE SARL - AIGNEP LATAM SAS
AIGNEP (Wuxi) FLUID TECHNOLOGY CO., LTD.
AIGNEP RUS LLC - AIGNEP DEUTSCHLAND GmbH. - AIGNEP MÉXICO S.A DE C.V.

PRODOTTI | PRODUCTS

Cinque sono le divisioni di prodotto di Aignep: le connessioni, gli innesti automatici, l'automazione, la serie Fluidity per il controllo dei fluidi, la serie Infinity per la distribuzione dell'aria compressa. Accanto alla produzione standard Aignep progetta e costruisce anche soluzioni customizzate, affiancando il cliente fino dalla fase della progettazione in una sorta di vera e propria partnership.

Aignep has 5 division of products: fittings, quick couplings, automations, fluid control (Fluidity), air pipeline (Infinity). Beside the standard production, Aignep designs and manufactures also customized solutions, providing assistance since the designing, with a real partnerships approach. Different applications: compressed air, automation, fluids distribution and even more complex processes which include stainless steel and special brass alloys.

Certificazioni | Certifications:

ISO 9001-2015, UL, NSF/ANSI 169, NSF/ANSI 51 - Tubes PTFE, EAC, Directive 2014/68/UE (PED), REACH, ROHS, Free of Silicon, Conflict Mineral, SUVA, DM174 - drinking water products, M.O.C.A., Directive 2014/34/UE (ATEX), EN 331:2015 for ball valves



➤ Raccordi e connessioni.
Fittings.



➤ Giunti automatici.
Quick couplings.



➤ Automazione.
Pneumatic.



➤ Infinity - rete aria compressa, gas inerti e vuoto.
Infinity - pipelines for compressed air, inert gas and vacuum.



➤ Fluidity - valvole per fluidi.
Fluidity - fluid control.



➤ Articoli speciali.
Special products.



aircomp
Automation

H

P

M

**AIRCOMP BY STAMPOTECNICA SRL**

Via Martiri di Cervarolo 5 - 42015 Correggio (RE)

Tel +39 0522 641840

www.aircomp.it - info@aircomp.it

PRESIDENTE | CHAIRMAN:

Tullio Sabattini

AMMINISTRATORE DELEGATO | CEO:

Ivano Parmigiani

**FATTURATO | TURNOVER:**

Euro 10.000.000,00

**DIPENDENTI | EMPLOYEES:**

73

**ALTRE INFORMAZIONI | OTHER INFORMATION**

AIRCOMP è la divisione di STAMPOTECNICA specializzata nella progettazione e produzione di una gamma completa di componenti pneumatici.

AIRCOMP è presente nei principali mercati grazie ad una rete commerciale di rivenditori nazionali ed esteri.

AIRCOMP is STAMPOTECNICA's division that is specialized in planning and production of a complete range of pneumatic components. AIRCOMP sells on the main markets through a sales network of national and foreign dealers.

PRODOTTI | PRODUCTS

- Unità trattamento aria compressa modulari da 1/4" a 1": regolatori, filtri, microfiltri, lubrificatori, moduli di sicurezza.
- Valvole a comando pneumatico, meccanico e manuale - Valvole a pedale.
- Elettrovalvole da 1/8 a 1/2" per uso singolo e per montaggio in batteria.
- Batterie valvole multipolari.
- Cilindri: ISO 15552, compatti, minicilindri, corsa breve.
- Raccordi e regolatori di flusso.
- Unità trattamento acqua: regolatori e filtri.
- *Modular air preparation units from 1/4" to 1", including regulators, filters, coalescing filters, lubricators, safety modules.*
- *Pneumatically, mechanically and manually operated valves - Pedal valves.*
- *Solenoid valves from 1/8 to 1/2" for single use or battery assembling.*
- *Multipole valve islands.*
- *ISO 15552, compact, minicylinders, short-stroke cylinders.*
- *Fittings and speed controllers.*
- *Modular water preparation units including regulators and filters.*

Certificazioni | Certifications:

ISO 9001:2015, ISO 14001:2015 e
ISO 450001:2018

- Regolatori e unità trattamento aria modulari, 1/8" ÷ 1".
Regulators, modular air preparation units 1/8" ÷ 1".



- Elettrovalvole e valvole pneumatiche 1/8" ÷ 1/2".
Solenoid and pneumatic valves 1/8" ÷ 1/2".



- Valvole ad azionamento meccanico e manuale 1/8" ÷ 1/2".
Mechanically and manually operated valves 1/8" ÷ 1/2".



- Isole di valvole con connessione multipolare.
Valve islands with multipole connection.



- Cilindri a norma ISO, compatti, corsa breve e minicilindri.
ISO cylinders, compact, short-stroke, minicylinders.



- Raccordi automatici, regolatori di flusso e silenziatori.
Push-in fittings, speed controllers and accessories.



- Regolatori e unità modulari trattamento acqua 1/8" ÷ 1/4".
Regulators and modular water preparation units 1/8" ÷ 1/4".



- Prodotti certificati M.O.C.A.
M.O.C.A. compliant products.



- Dispositivi di gonfiaggio rapido per il garage equipment.
Quick filling valves designed for garage equipment.





Airon Iberica



AIRON SRL

Via Marçinelle 8 - 45100 Rovigo (RO)
Tel +39 0425 471575 - Fax +39 0425 404037
www.airon-pneumatic.com
info@airon-pneumatic.com

AMMINISTRATORE | MANAGING DIRECTOR:
Giorgio Barella



FATTURATO | TURNOVER:
Euro 7.000.000,00



DIPENDENTI | EMPLOYEES:
29



ALTRE INFORMAZIONI | OTHER INFORMATION

Presenza diffusa in Italia e in diversi paesi esteri attraverso distributori specializzati, in Spagna, Germania, Francia, Regno Unito, Croazia, Romania, Turchia, Emirati Arabi Uniti, Tailandia, Sri Lanka, Cina, Stati Uniti.

Widespread presence in Italy and in several foreign countries through specialized distributors, in Spain, France, United Kingdom, Croatia, Romania, Turkey, United Arab Emirates, Thailand, Sri Lanka, China, United States of America.

PRODOTTI | PRODUCTS

Attuatori: pneumatici a norma e non, con trasduttore di posizione, antirotazione, telescopici, senza stelo, rotanti, anticorrosione, guide lineari, boosters, dosatori, sensori, attuatori elettrici.

Valvole: a comando elettrico/pneumatico/manuale/meccanico.

Trattamento aria: filtri, regolatori, lubrificatori, avviatori progressivi, pressostati, ≤ 40 bar.

Raccordi: in polimero/ottone/acciaio inox. Dosatori di flusso, valvole automatiche, silenziatori, tubi.

Actuators: standard and not pneumatics, position transducer, anti-rotation, telescopic, rodless, rotating, corrosion proof, linear guide, boosters, filling units, sensors, electric actuators.

Valves: electrical/pneumatic/manual/mechanical.

Air Treatment: filters, regulators, lubricators, soft start-up valves, pressure switches, ≤ 40 bar.

Fittings: polymer/brass/stainless steel. Flow regulators, automatic valves, silencers, hoses.

- Assistenza tecnica nella progettazione, costantemente a fianco del cliente.
Technical assistance during design following customer's needs.



- Attuatori pneumatici ed elettrici, distributori, trattamento aria, accessori.
Pneumatic and electric actuators, distributors, air treatment, accessories.



- Disponibilità nella realizzazione di prodotti personalizzati.
Available to manufacture customized products.





AIRWORK PNEUMATIC EQUIPMENT SRL
Via Piemonte 3/5 - 20841 Carate Brianza (MB)
Tel +39 0362 645951 - Fax +39 0362 645979
www.airwork.it
info@airwork.it

AMMINISTRATORE | MANAGING DIRECTOR:
Giuseppe Ongis



ALTRE INFORMAZIONI | OTHER INFORMATION

Rete commerciale | Commercial network:
Presenza mondiale in più di 50 Paesi tramite rappresentanze esclusive.

Worldwide presence in more than 50 Countries through an exclusive sales network.

TUNITEK INDUSTRIES
z.i. Afi El Agba, Bardo 2051 - Tunis

PRODOTTI | PRODUCTS

Con oltre 20 anni di esperienza, Airwork offre una panoramica completa di componenti per l'automazione industriale:

- Cilindri a normativa ISO e non, cilindri compatti guidati, unità di guida, attuatori rotanti, bloccasteli e regolatori idraulici di velocità.
- Valvole normalizzate e non, ad azionamento elettrico, pneumatico, meccanico e manuale.
- Unità di trattamento aria.
- Raccordi e tuberia.
- Soluzioni speciali.

With more than 20 years of experience Airwork offers a complete range of products for the industrial automation:

- *Standard cylinders ISO and not normalized, compact guided cylinders, guide units, rotary actuators, rod-lock units, hydraulic speed regulators.*
- *Normalized ISO and not normalized valves, solenoid, pneumatic, mechanical and manual actuated.*
- *Air preparation units.*
- *Fittings and tubes.*
- *Customized and special solutions.*

H

P

M

PRODOTTI | PRODUCTS

Cilindri pneumatici realizzati in molteplici versioni e che, grazie a numerosi accessori di montaggio, possono avere i più svariati utilizzi in diversi campi:

- Valvole ed elettrovalvole pensate per coprire tutte le esigenze di portata e funzione e disponibili per uso singolo o in batteria;
- Unità di trattamento aria da 1/8 a 1", disponibile in tecnopolimero o metallo; Raccordi in tecnopolimero, ottone nichelato o acciaio inox.

Pneumatic cylinders available in several versions that with a complete range of mounting accessories can be used and installed in multiple fields:

- *Valves and solenoid valves designed to suit every flow or function requirement, with the possibility to be used singularly or on a manifold;*
- *Air preparation units from 1/8 to 1", in techno-polymer or metal; Techno-polymer, nickel plated brass or stainless-steel fittings.*



➤ Gamma completa gruppi trattamento aria e raccorderia.
Full range of air preparation units and fittings.

➤ Gamma completa di cilindri pneumatici a normativa ISO o non normalizzati.
Full range of pneumatic cylinders according to ISO norm or not normalized.



➤ Gamma completa di elettrovalvole, valvole pneumatiche, manuali e meccaniche.
Full range of solenoid valves, pneumatic, manual and mechanical valves.





ARGO
HYTOS
A Voith Company

H

P

M

**ARGO-HYTOS SRL**

Via Salvador Allende 69/71 - 41122 Modena (MO)

Tel +39 059 7880801

www.argo-hytos.com

info.it@argo-hytos.com

DIRETTORE GENERALE | GENERAL MANAGER:

Mario Meloni

**FATTURATO | TURNOVER:**

Euro 8.900.000,00

**DIPENDENTI | EMPLOYEES:**

18

**ALTRE INFORMAZIONI | OTHER INFORMATION**

Headquarter
Baar, Switzerland

Stabilimenti produttivi e commerciali |*Production & Sales Entities:*

Kraichtal, Germany - Vrchlábí, Czech Republic -
Coimbatore, India - Yangzhou, China - Zator,
Poland - Jundiaí (São Paulo), Brazil - Bowling
Green (OH), USA

Filiali | Sales Entities:

Ostrava, Czech Republic - Rotherham, UK -
Maassluis, Netherlands - Forbach, France -
Malmö, Sweden - Istanbul, Turkey - Hong Kong,
China

PRODOTTI | PRODUCTS

Componenti oleodinamici per applicazioni sia
mobili che stazionarie in molteplici settori:
filtri completi ed elementi filtranti - valvole
ed elettrovalvole (on/off, proporzionali,
antideflagranti) - schede elettroniche di
comando - soluzioni di sistemi - sistemi
integrati - serbatoi olio completi in plastica -
sensori per analisi sui fluidi - unità di filtrazione
- centraline complete.

*Hydraulic components for mobile and
stationary application in different industries:
complete filters and filter elements - valves
and solenoid valves (on/off, proportional,
explosion proof) - electronic control unit
- system solutions - integrated systems -
complete plastic oil tanks - sensors for fluid
analysis - filter units - complete powerpacks.*

- Filtri oleodinamici.
Hydraulic filters.



- Valvole ed elettrovalvole oleodinamiche.
Hydraulic valves and solenoid valves.



- Sistemi integrati e soluzioni di sistemi.
Integrated systems and system solutions.



- Elementi filtranti ad alte prestazioni.
High performance filter elements.



- Sensori per analisi sui fluidi.
Sensors for fluid analysis.



- Unità di filtrazione.
Filter units.



- Soluzioni per la deaerazione nei serbatoi olio.
Solutions for air separation in oil tanks.



- Sistema innovativo di connessione rapida.
Innovative quick connect system.



- Serbatoi olio completi in plastica.
Complete plastic oil tanks.





ALTRE INFORMAZIONI | OTHER INFORMATION

Dal 2019 Artec opera in un nuovo e più ampio stabilimento situato a Cento. Questa nuova sede operativa comprende sia gli uffici che i reparti produttivi.

From 2019, Artec is located in a new and bigger building in Cento. This new unit includes both offices and production departments.

PRODOTTI | PRODUCTS

Artec progetta e produce cilindri pneumatici per l'automazione industriale dal 1982.

Il catalogo comprende prodotti standard e non, sia in alluminio che in inox.

- Minicilindri ISO 6432, cilindri ISO 15552 e cilindri compatti ISO 21287.
- Cilindri tondi, unitop, compatti guidati, corsa breve, stopper, a cartuccia, con profilo pulito, senza stelo.
- Pinze pneumatiche, serbatoi, accessori e fissaggi per cilindri pneumatici.

Artec has designed and produced pneumatic cylinders for industrial automation since 1982. Its catalogue includes standard and non-standard products, both in aluminium and stainless steel.

- ISO 6432 microcylinders, ISO 15552 cylinders, ISO 21287 compact cylinders.
- Cylinders: round, unitop, guided compact, short stroke, stopper, cartridge, with clean profile, rodless.
- Pneumatic grippers, reservoirs, mounting parts and accessories for pneumatic cylinders.



ARTEC SRL

Via Benedetto Zallone 24 - 44042 Cento (FE)
Tel +39 051 6836220 - Fax +39 051 6830882
www.artec-pneumatic.com
info@artec-pneumatic.com

DIRETTORE COMMERCIALE | SALES MANAGER:
Alberto Fortini



FATTURATO | TURNOVER:
Euro 8.500.000,00



DIPENDENTI | EMPLOYEES:
42

➤ Cilindri pneumatici standard.
Standard pneumatic cylinders.



➤ Gamma completa di cilindri pneumatici. Cilindri compatti.
Complete range of pneumatic cylinders. Compact cylinders.



➤ Cilindri in acciaio inox.
Stainless steel cylinders.





BONDIOLI & PAVESI 



BONDIOLI & PAVESI SPA
Via 23 Aprile 35/A - 46029 Suzzara (MN)
Tel +39 0376 5141
www.bondioli-pavesi.com
bp@bondioli-pavesi.com

AMMINISTRATORE | MANAGING DIRECTOR:
Carlo Bondioli



FATTURATO | TURNOVER:
Euro 400.000.000,00



DIPENDENTI | EMPLOYEES:
1900



ALTRE INFORMAZIONI | OTHER INFORMATION

Società all'estero | Foreign associated companies:

Brasile, Cina, Danimarca, Francia, Germania, India, Olanda, Polonia, Spagna, Ucraina, USA.

Brazil, China, Denmark, France, Germany, India, Netherlands, Poland, Spain, Ukraine, USA.

PRODOTTI | PRODUCTS

Valvole di controllo direzionale monoblocco, componibili e load sensing, manifold, valvole a cartuccia, pompe e motori a pistoni assiali a portata fissa e variabile per circuiti aperti e chiusi, unità elettroniche di controllo, pompe e motori ad ingranaggi, divisori di flusso, servocomandi idraulici, unità di alimentazione, scambiatori di calore aria-olio standard, scambiatori di calore combinati, trasmissioni cardaniche, scatole ad ingranaggi, scatole ingranaggi ad assi paralleli.

Monoblock, modular and load sensing directional control valves, manifolds, cartridge valves, variable and fixed displacement-axial piston pumps and motors for open and closed circuits, electronic control units, gear pumps and motors, flow dividers, servo-controls, feeding units, air-oil standard heat exchangers, combined heat exchangers, PTO drive shafts, gearboxes, parallel axis gearboxes.

- HUB è una nuova generazione di componenti intelligenti per sistemi di trasmissione.
HUB is a new generation of intelligent and integrated power systems components.



- Sistema integrato di trasmissione in una mietitrebbia.
Integrated Power System in a Combine harvester application.



- Sistema integrato di trasmissione in un sollevatore telescopico.
Integrated Power System in a Telescopic handler application.





cmatic[®]
P N E U M A T I C F I T T I N G S

H

P

M

**C.MATIC SPA**

Via G. Matteotti 32 - 20833 Giusano (MB)
Tel +39 0362 805246 - Fax +39 0362 805262
www.cmatic.com
cmatic@cmatic.it

PRESIDENTE | CHAIRMAN:
Orazio Confalonieri



FATTURATO | TURNOVER:
Euro 22.300.000,00



DIPENDENTI | EMPLOYEES:
75

**ALTRE INFORMAZIONI | OTHER INFORMATION**

Società all'estero | Foreign associated companies:

- Stati Uniti - *United States*
Cmatic USA, INC.
New York
- Cina - *China*
Cmatic (Shanghai) Fluid Technology Co., Ltd.
Shanghai

Distributori nel mondo | Worldwide distributors:

Cmatic dispone di una capillare rete di distributori in: Arabia Saudita, Austria, Bosnia Erzegovina, Bulgaria, Canada, Cina, Danimarca, Egitto, Emirati Arabi, Finlandia, Francia, Germania, Gran Bretagna, Grecia, India, Iran, Irlanda, Italia, Lituania, Malta, Marocco, Norvegia, Olanda, Perù, Polonia, Portogallo, Repubblica Ceca, Romania, Russia, Singapore, Spagna, Stati Uniti, Sud Africa, Svezia, Svizzera, Taiwan, Thailandia, Turchia, Ucraina, Ungheria.

Cmatic has a broad network of distributors in: Saudi Arabia, Austria, Bosnia and Herzegovina, Bulgaria, Canada, China, Denmark, Egypt, United Arab Emirates, Finland, France, Germany, Great Britain, Greece, India, Iran, Ireland, Italy, Lithuania, Malta, Morocco, Norway, Netherlands, Peru, Poland, Portugal, Czech Republic, Romania, Russia, Singapore, Spain, United States, South Africa, Sweden, Switzerland, Taiwan, Thailand, Turkey, Ukraine, Hungary.

PRODOTTI | PRODUCTS

Cmatic è dal 1979 lo specialista nello sviluppo e produzione di Raccorderia Industriale. Tra le tipologie prodotte vi sono: Raccordi Automatici, Standard, a Ogiva, a Calzamento, a Funzione, Innessi Rapidi e Connettori Multipli. I prodotti vengono utilizzati in tutti i settori dell'automazione pneumatica (inclusi Alimentare, Chimico-Farmaceutico e Vending), Lubrificazione, Nebulizzazione, Trasporti e Idraulica.

Since 1979 Cmatic ranks among the leading developers and manufacturers of Pneumatic Fittings. Our core business is Push-in, Push-on, Compression, Standard and Function Fittings, Couplings and Multiple Connectors. Cmatic products can be used in a multitude of applications and market segments as Pneumatic Automation (Food, Chemical, Pharma and Vending Machine), Lubrication, Misting, Transportation.

➤ Raccordi Automatici.
Push-in Fittings.



➤ Raccordi a Calzamento.
Push-on Fittings.



➤ Raccordi a Ogiva.
Compression Fittings.



➤ Raccordi Standard.
Standard Fittings.



➤ Innesti Rapidi e Innesti Rapidi di Sicurezza.
Couplings and Safety Couplings.



➤ Connettori Multipli.
Multiple Connectors.



➤ Raccordi a Funzione.
Function Fittings.



➤ Tools.



➤ Gamma completa dei prodotti Cmatic.
Full overview of the Cmatic's product offer.



**PRODOTTI | PRODUCTS**

Costruzione di impianti (centraline), banchi prova, cilindri oleodinamici - Distribuzione e assemblaggio di tubazioni flessibili e raccordi.

Oleodinamica: distributori, deviatori/invertitori di flusso manuali, motori orbitali, innesti rapidi, accumulatori, filtri, guarnizioni, manometri, pompe, raccorderia, valvole, masselli modulari, elettrovalvole.

Pneumatica: cilindri, guide, valvole, elettrovalvole, gruppi per il trattamento aria, raccordi.

Production of hydraulic systems (powerpacks), test benches, cylinders - Distribution and assembly of hoses and joints.

Hydraulics: manual flow distributors diverter/inverter, orbital motors, quick couplings, accumulators, filters, seals, pressure gauges, pumps, fittings, valves, modular blocks, solenoid valves.

Pneumatics: cylinders, guides, valves, solenoid valves, air treatment systems, fittings.

cope

**C.O.P.E. COMPONENTI OLEODINAMICA
PNEUMATICA ELETTRONICA SRL**

Via Papa Giovanni XXIII, 15 - 25086 Rezzato (BS)
Tel +39 030 3760255 - Fax +39 030 3365657
www.cope-italy.it - info@cope-italy.it

AMMINISTRATORE | MANAGING DIRECTOR:
Luca Stanga



FATTURATO | TURNOVER:
Euro 4.398.000,00



DIPENDENTI | EMPLOYEES:
14

H
P
M

- Impianti oleodinamici completi.
Whole oleodynamic power.



- Centraline oleodinamiche.
Oleodynamic power plant.



- Cilindri oleodinamici e pneumatici.
Hydraulic and pneumatic cylinders.



- Componenti vari per cilindri oleodinamici.
Components for hydraulic cylinders.



- Distributori manuali.
Manual distributors.



- Blocchi oleodinamici standard e a disegno.
Hydraulic manifold.



- Valvole oleodinamiche con diverse applicazioni.
Oleodynamic valves with different applications.



- Tubi flessibili in gomma e raccordi.
Hydraulic hose, fittings and hydraulic accessories.



- Programma completo di pneumatica per automazioni.
Pneumatic components for industrial automation.





H
P
M



CAMOZZI AUTOMATION SPA

Via Eritrea 20/I - 25126 Brescia (BS)
Tel +39 030 37921 - Fax +39 030 2400464
www.camozzi.com
info@camozzi.com

PRESIDENTE E CEO | CHAIRMAN AND CEO:
Lodovico Camozzi



FATTURATO | TURNOVER:
Euro 189.186.000,00



DIPENDENTI | EMPLOYEES:
2130



ALTRE INFORMAZIONI | OTHER INFORMATION

Presenza globale tramite distributori esclusivi in oltre 75 paesi e 26 filiali in Austria, Germania, Regno Unito, Francia, Olanda, Svezia, Danimarca, Norvegia, Estonia, Repubblica Ceca, Spagna, Polonia, Serbia, Kazakistan, Uzbekistan, Ucraina, Turchia, Stati Uniti, Messico, Brasile, Argentina, Venezuela, Cina, India, Malesia, Vietnam.

Worldwide presence in more than 75 countries with authorized distributors and 26 subsidiaries in Austria, Germany, United Kingdom, France, the Netherlands, Sweden, Denmark, Norway, Estonia, Czech Republic, Spain, Poland, Serbia, Kazakhstan, Uzbekistan, Ukraine, Turkey, USA, Mexico, Brazil, Argentina, Venezuela, China, Malaysia, Vietnam.

Sede legale: Via R. Rubattino 81
20146 Milano (MI)

PRODOTTI | PRODUCTS

Componenti, sistemi e tecnologie per il settore dell'Automazione Industriale, il controllo dei fluidi liquidi e gassosi e applicazioni dedicate all'Industria dei Trasporti e del Life Science. La gamma comprende anche prodotti e soluzioni IIoT per la digitalizzazione dei processi industriali.

Camozzi designs and produces motion and fluid control components, systems and technologies for Industrial Automation, Transportation and Life Science industries. The range includes also IIoT solutions and products for digitalization of industrial processes.



➤ Soluzioni robuste e affidabili per il settore trasporti.
Reliable solutions for the Transportation industry.

➤ Componenti, sistemi e tecnologie all'avanguardia per ogni esigenza applicativa.
Components, systems and highly advanced technologies for any application need.

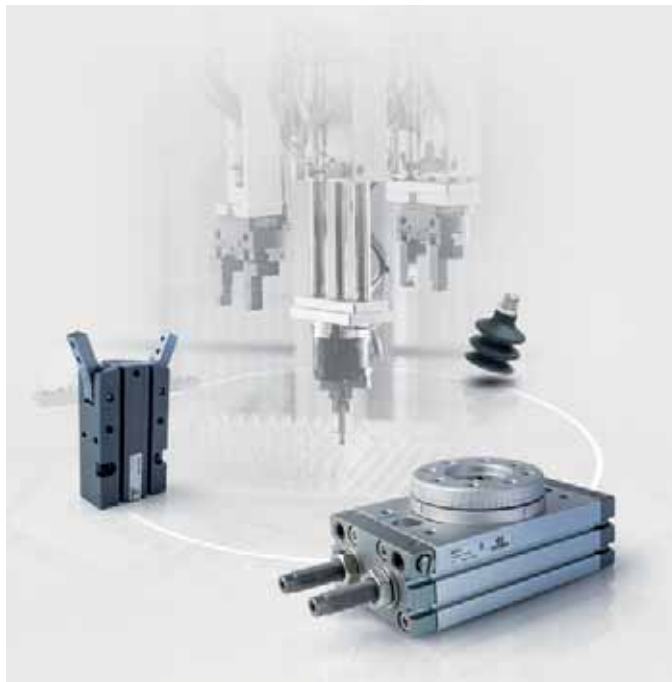

➤ Componenti e soluzioni personalizzate per il controllo di fluidi liquidi e gassosi.
Components and customised solutions for the fluid control of liquids and gases.





➤ Cilindri e accessori per l'attuazione pneumatica.
Cylinders and accessories for pneumatic actuation.



➤ Cilindri, assi, accessori per l'attuazione elettrica.
Cylinders, axes, accessories for electric actuation.



➤ Pinze angolari, parallele, a 3 dita e per materozza.
Angular, parallel, three-jaw and sprue grippers.



➤ Ventose, eiettori, filtri/accessori per il vuoto.
Suction pads, ejectors, vacuum filters/accessories.



➤ Valvole pneumatiche, meccaniche/manuali, elettrovalvole.
Pneumatic, mechanical/manual, solenoid valves.



➤ Isole di valvole multipolari/seriali e moduli seriali.
Multipole/Fieldbus valve islands and modules.



➤ Valvole, servo valvole e regolatori proporzionali.
Proportional valves, servo valves and regulators.



➤ FRL modulari, regolatori, pressostati, manometri.
Modular FRL, pressure regulators, switches, gauges.



➤ Raccordi e accessori per la connessione pneumatica.
Fittings and accessories for pneumatic connection.



➤ Soluzioni su misura progettate insieme al cliente.
Tailor-made solutions designed with the customer.



➤ Regolatore "smart" con tecnologia CoilVision®.
"Smart" regulator with CoilVision® technology.



➤ Isola di valvole "smart" con tecnologia CoilVision®.
"Smart" valve island with CoilVision® technology.



CATTINI E FIGLIO SPA

Via dell'Ecologia 1 - 20059 Casarile (MI)
Tel +39 02 900531
www.cattini.com
sales@cattini.com

AMMINISTRATORE DELEGATO | CEO:

Lorenzo Cattini



FATTURATO | TURNOVER:

Euro 73.000.000,00



DIPENDENTI | EMPLOYEES:

290



ALTRE INFORMAZIONI | OTHER INFORMATION

Unità produttiva ingranaggi conici |

Bevel gears production unit:
Via L. da Vinci 12 - 20059 Casarile (MI)

Unità produttiva trattamento termico |

Heat treatment unit:
Via dei Marinoni 29 - 27040 Cigognola (PV)

Società all'estero | Foreign entities:

Cattini North America Corp.
21740 Hagerstown, MD, USA

Cattini Power Transmission Pvt. Ltd.
411006 Pune - Maharashtra - India

Certificazioni | Certifications:

IATF 16949, ISO 14001 e ISO 45001

PRODOTTI | PRODUCTS

La Cattini può produrre ogni tipologia di ingranaggio per veicoli professionali e le più importanti applicazioni industriali. Ogni processo produttivo e di controllo è disponibile per il pieno raggiungimento degli obiettivi di progetto.

Cattini's technical competence can offer every kind of gears and geared elements for vocational vehicles and the heavy duty industrial applications. All production and quality processes are available to fulfill Customer's targets.



➤ Ingranaggio rettificato diam. max. 500 mm.
Ground gear max. diam. 500 mm.

➤ Corona conica rettificata max. 600 mm.
Ground bevel gear max. diam. 600 mm.



➤ Corona epicicloideale diam. max 600 mm.
Planet ring gear max. diam. 600 mm.



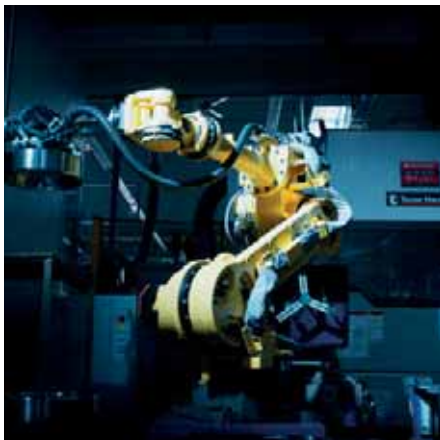

➤ Isola dentatura creatore.
Gear hobbing cell.



➤ Isola rettifica evolvente.
Gear grinding cell.



➤ Ingranaggi per trasmissioni DCT/CVT/PowerShift.
Gears for DCT/CVT/PowerShift transmissions.



➤ Isola dentatura conica.
Bevel gear cutting cell.



➤ Tempra sotto pressa.
Press quenching.



➤ Coppia conica rettificata.
Ground bevel gear set.

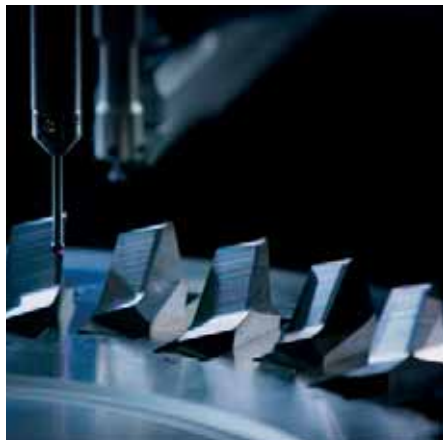

➤ Controllo posizionamento lame.
Cutter positioning check.

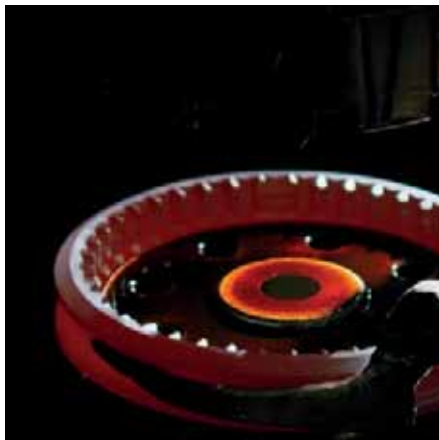

➤ Tempra a tampono.
Plug quenching.

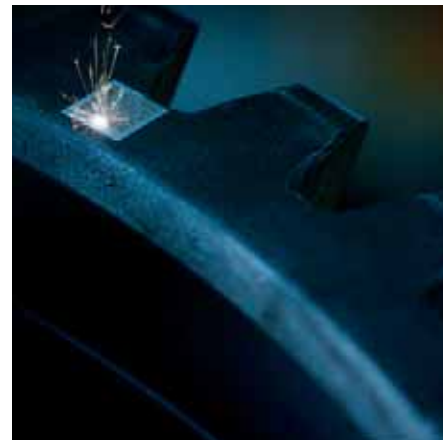

➤ Marchiatura laser QR Code.
Laser etching QR Code.



➤ Dettaglio di un sincronizzatore.
Detail view of a synchronizer.



➤ Ingranaggi saldati fascio elettronico e rettificati.
EB welded and ground gears.



➤ Coppia riduzione finale rettificata e pallinata.
Final drive, ground and shot-peened gear pair.



PRODOTTI | PRODUCTS

CBF produce una completa e specializzata gamma di valvole oleodinamiche: Valvole di massima pressione, Valvole riduttrici di pressione, Valvole overcenter, Divisori di flusso, Regolatori di flusso, Valvole di blocco, Valvole di esclusione e sequenza, Valvole per montaggio modulare, Valvole elettriche, Valvole di fine corsa, pompe manuali. L'azienda costruisce inoltre monoblocchi e sistemi oleodinamici personalizzati che vengono sviluppati in collaborazione con il cliente.

CBF is specialized in the production of a complete range of hydraulic valves like Relief valves, Pressure reducing valves, Overcenter valves, flow divider, flow regulator, relief-unloading sequence valves, sandwich mounting valves, electric valves, manual pump.

CBF manufactures also hydraulic systems under customer specifications.

CBF hydraulic®



CBF SRL

Via Caboto 3 - 36075 Montecchio Maggiore (VI)
Tel +39 0444 499141/3 - Fax +39 0444 499145
www.cbphydraulic.com - info@cbphydraulic.com

RESPONSABILE COMMERCIALE |

SALES MANAGER:
Massimo Balbinot



FATTURATO | TURNOVER:
Euro 6.020.000,00



DIPENDENTI | EMPLOYEES:
35

H
P
M

- VALVOLE OVERCENTER: semplice o doppio effetto.
OVERCENTER VALVES: single or double effect.



- VALVOLE DI MASSIMA PRESSIONE: con collettore o a cartucce.
RELIEF VALVES: in body or cartridge style.



- VALVOLE ELETTRICHE: a 2, 3 o 4 vie.
ELECTRIC VALVES: 2, 3, or 4 ways.



- BLOCCHI SU RICHIESTA.
CUSTOMIZED MANIFOLDS.



- VALVOLE DI BLOCCO E NON RITORNO: semplici o doppio effetto.
CHECK VALVE: single or double effect.



- REGOLATORI DI FLUSSO: strozzatori, Regolatori a 2 o tre vie.
NEEDLE VALVE: 2 or 3 way pressure compensated.



- CETOP: semplice o doppio effetto, NG6, NG10, NG16.
CETOP: single or double effect, NG6, NG10, NG16.



- VALVOLE FLANGIABILI SU MOTORI IDRAULICI.
VALVES FOR HYDRAULIC MOTORS.



- SAE: semplice o doppio effetto, per flangiature SAE.
SAE: single or double effect, available for SAE.





ALTRE INFORMAZIONI | OTHER INFORMATION

Configura e acquista il tuo cilindro, scarica i modelli CAD 2D/3D e la documentazione tecnica su confortinet.com.

Rete di vendita e assistenza in tutti i paesi europei, USA e Sud America.

Configure and order your cylinder, download 2D/3D CAD models and technical documentation on confortinet.com.

Distribution network in every European country, USA and South America.

PRODOTTI | PRODUCTS

Gamma completa di cilindri idraulici a norma ISO 6020/2 e ISO 6022, equipaggiabili con sensori di prossimità e con trasduttore di posizione.

Cilindri compatti in acciaio per impieghi gravosi o in alluminio con sensori magnetici di prossimità.

Attuatori rotanti con sensori magnetici di prossimità.

Kit per l'assemblaggio di cilindri idraulici.

Full range of hydraulic cylinders in compliance with ISO 6020/2 and ISO 6022, available with proximity switches and position transducer. Compact cylinders in steel for heavy duty applications or aluminium with magnetic proximity switches.

Rotary actuators with magnetic proximity switches.

Hydraulic cylinders assembly kit.



CONFORTI



CONFORTI OLEODINAMICA SRL

Via Boccioni 10 - 20900 Monza (MB)

Tel +39 039 835125

www.confortinet.com

conforti@confortinet.com

CEO:

Matteo Conforti Andreoni



FATTURATO | TURNOVER:

Euro 5.500.000,00



DIPENDENTI | EMPLOYEES:

20

H

P

M

- Cilindri idraulici ISO 6020/2 con sensori magnetici.
ISO 6020/2 cylinders with magnetic switches.



- Configura e ordina su confortinet.com.
Configure and order on confortinet.com.

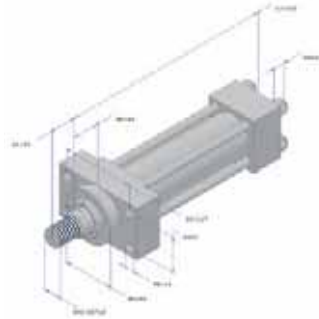

- Cilindri idraulici ISO 6022 - 250 bar.
ISO 6022 hydraulic cylinders - 250 bar.



- Servocilindri ISO 6020/2 con trasduttore di posizione.
ISO 6020/2 servocylinder with transducer.



- Cilindri compatti in acciaio e alluminio con sensori.
Compact cylinder in steel/aluminium with sensors.



- Servocilindri ISO 6022 con trasduttore di posizione.
ISO 6022 servocylinders with position transducer.



- Cilindri idraulici ISO 6020/2 con controflange.
ISO 6020/2 cylinders with counterflanges.



- Kit per cilindri ISO 6020/2 e ISO 6022.
Assembly kit for ISO 6020/2 and ISO 6022 cylinders.



- Attuatore rotante con sensori magnetici di posizione.
Rotary actuator with magnetic switches.





D.N.P. INDUSTRIALE SRL

Via B. Buozzi 10 - 20861 Brugherio (MB)

Tel +39 039 877451

www.dnp.it

info@dnp.it

CEO (CHIEF EXECUTIVE OFFICER):

Michele De Isabella



FATTURATO | TURNOVER:

Euro 26.000.000,00



DIPENDENTI | EMPLOYEES:

54



ALTRE INFORMAZIONI | OTHER INFORMATION

D.N.P. opera su tutti i mercati Mondiali attraverso una rete di Distributori Ufficiali che garantiscono supporto commerciale e tecnico. Nel 2011 viene aperta la filiale D.N.P. Americas per soddisfare le esigenze dei mercati di Stati Uniti e Canada

D.N.P. operates on all world markets through a network of official distributors who guarantee commercial and technical support. In 2011 the D.N.P. Americas branch was opened to meet the needs of the markets of United States and Canada.

PRODOTTI | PRODUCTS

Innesti Rapidi Faccia Piana / Innesti Rapidi a valvola o a sfera / Innesti Rapidi tipo Push Pull / Innesti Rapidi Push Pull per tubo rigido / Innesti Rapidi a Vite con valvola / Innesti Rapidi per impianti frenanti / Valvole unidirezionali / Innesti Rapidi in Acciaio Inossidabile / Colour Code Safety System / Piastre multi-connesione.

Ball Quick Coupling / Brake Valve / Connection Under Pressure / Decompression Valve / Flat Face / Flat Face Stainless Steel / Flat Face Screw Couplings Pin Lock / Flanged Flat Face Screw Couplings / Free Flow Quick Coupling / High Pressure Screw Couplings / High Resistance Screw Coupling / Male Connectable Under Pressure / Poppet Quick Couplings / Push Pull / Screw Couplings / Special Executions / Stainless Steel / Wing nut Quick Coupling / Uhp Couplings / Color Code Safety System / Multi connection.

H

P

M

- DNP progetta e produce un'ampia gamma di piastre multi-connesione personalizzate per numerose applicazioni.
D.N.P. designs and manufactures a wide range of customized multi-couplings for many applications.



- D.N.P. realizza una delle gamme più complete di Innesti Rapidi per impianti Oleodinamici al mondo.
D.N.P. produces one of the most complete ranges of Quick Couplings for hydraulic systems in the world.



- **Color Code:**
 È un sistema di identificazione delle differenti linee che compongono un circuito idraulico complesso.
It is an identification system of the different lines that make up a complex hydraulic circuit.





DUPLOMATIC
MOTION SOLUTIONS

a member of **DAIKIN** group

H

P

M



DUPLOMATIC MS SPA

Via Mario Re Depaolini 24 - 20015 Parabiago (MI)
Tel +39 0331 895111 - Fax +39 0331 895259
www.duplomaticmotionsolutions.com
vendite.ita@duplomatic.com
sales.exp@duplomatic.com

AMMINISTRATORE DELEGATO | CEO:

Roberto Maddalon



FATTURATO | TURNOVER:

Euro 57.300.000,00



DIPENDENTI | EMPLOYEES:

221



ALTRE INFORMAZIONI | OTHER INFORMATION

Società all'estero | Foreign associated companies:

- Duplomatic Hydraulics Shanghai (Shanghai, Cina)
- Duplomatic Middle East (Dubai, UAE)
- Continental Hydraulics (Minnesota, USA)
- Hydreco Hydraulics Ltd. (UK)
- Hydreco Hydraulics GmbH (Germany)
- Hydreco Hydraulics Norway A/S (Norway)
- Hydreco Hydraulics India Ltd. (India)
- Hydreco Hydraulics Pty Ltd. (Australia)
- GÜNTER TILL GMBH & CO. KG Präzisionsmechanik (Germany)

PRODOTTI | PRODUCTS

- Valvole convenzionali, Valvole proporzionali, Soluzioni bus di campo e IO-Link, Servo-cilindri oleodinamici, Pompe oleodinamiche, Attuatori elettrici.
 - Sistemi idraulici complessi per industria, energia, offshore, siderurgia.
 - Progetti chiavi in mano speciali e innovativi (EXPO 2020).
 - Serie ibrida Daikin.
- *Hydraulic pumps, Electric actuators.*
 - *Conventional valves, Proportional valves, Fieldbus and IO-Link Solutions, Hydraulic servo-cylinders, Hydraulic pumps, Electric actuators.*
 - *Complex hydraulic systems for industry, energy, off-shore, iron & steel.*
 - *Special and innovative turnkey projects (EXPO 2020).*
 - *Daikin hybrid series.*



➤ Sistemi oleodinamici.
Hydraulic Systems.

- Valvole convenzionali, Valvole proporzionali, Soluzioni bus di campo e IO-Link, Servo-cilindri oleodinamici, Pompe oleodinamiche e Attuatori elettrici.
Conventional valves, Proportional valves, Fieldbus and IO-Link Solutions, Hydraulic servo-cylinders, Hydraulic pumps and Electric actuators.



- Centralina idraulica ibrida ECORICH, SUT e refrigeratori a circolazione con compressore controllato da inverter by Daikin.
ECORICH hybrid unit, SUT and water-based chillers, circulating type with inverter-controlled compressor by Daikin.





ALTRE INFORMAZIONI | OTHER INFORMATION

Presenza globale tramite agenti e distributori.
Filiali in Cina, USA e Tunisia.

*Worldwide presence with representatives
and distributors.
Branch offices in China, USA and Tunisia.*

PRODOTTI | PRODUCTS

Dal 1977 azienda specializzata nella progettazione e produzione di apparecchi di controllo per fluidi:

- Pressostati e vuotostati.
- Termostati.
- Flussimetri e flussostati.
- Livellostati.
- Sensori di livello.
- Pressostati elettronici.
- Trasmettitori di pressione.
- Indicatori digitali.
- Trasduttori di pressione.

*Since 1977 specialized in the design and
manufacturing of control devices for fluids:*

- *Pressure and vacuum switches.*
- *Temperature switches.*
- *Flow indicators and switches.*
- *Float level switches.*
- *Level sensors.*
- *Electronic pressure switches.*
- *Pressure transmitters.*
- *Digital indicators.*
- *Pressure transducers.*



ELETTROTEC SRL

Via Jean Jaurès 12 - 20125 Milano (MI)
Tel +39 02 28851811 - Fax +39 02 28851854
www.elettrotec.com
info@elettrotec.com

DIRETTORE COMMERCIALE | SALES MANAGER:

Ing. Luca Riva



➤ Pressostati regolabili a membrana e a pistone.
Adjustable membrane and piston pressure switches.



➤ Termostati bimetallici con punto d'intervento fisso.
Bimetallic temperature switches with fixed set-point.



➤ Trasduttori di pressione.
Pressure transducers.



➤ Livellostati e sonde di livello a galleggiante.
Float level switches and level sensors.



➤ Vuotostati regolabili a membrana.
Adjustable membrane vacuum switches.



➤ Flussimetri e flussostati ad area variabile.
Variable area flow meters and switches.

**EMMEGI SPA**

Via Newton Z.i. 52 - 20062 Cassano d'Adda (MI)
Tel +39 0363 360236 - Fax +39 0363 360230
www.emmegi-heat-exchangers.com
info@emmegi-heat-exchangers.com

AMMINISTRATORE | MANAGING DIRECTOR:
Massimo Lavezzari



FATTURATO | TURNOVER:
Euro 34.089.000,00



DIPENDENTI | EMPLOYEES:
195

**ALTRE INFORMAZIONI | OTHER INFORMATION**

Società all'estero | Foreign associated companies:

- Emmegi Sro (Slovakia) - Production.
- Emmegi Gmbh (Germany) - Sales.
- Emmegi Nordic (Sweden/Finland) - Sales.
- Emmegi Inc. (U.S.A.) - Sales.
- Emmegi Termal (Turkey) - Sales.
- Emmegi Uk Ltd. (Uk) - Sales.

PRODOTTI | PRODUCTS

- Scambiatori Aria-Olio.
- Scambiatori Acqua-Olio.
- Combinati per Macchine Mobili.
- Combinati per Compressori.
- Gruppi autonomi di ricircolo.
- Serie Mobile.
- Accessori: valvole, termostati.
- Prodotti speciali a disegno.
- Serie HPA Compact.
- Serie HPV e KBV.
- Serie HPeX e HPAM.
- *Air-Oil Heat exchangers.*
- *Water-Oil Heat exchangers.*
- *Combined for Moving Machinery.*
- *Combined for Compressors.*
- *Autonomous cooling units.*
- *Mobile Series.*
- *Accessories: valves, thermostats.*
- *Special coolers by customer's drawing.*
- *HPA Compact series.*
- *HPV and KBV series.*
- *HPeX and HPAM series.*

H

P

M

- Scambiatori Aria-Olio serie HPeX.
Air-oil-exchangers HPeX Series.



- Gruppi autonomi di raffreddamento Serie SILENT EVO3.
Offline cooling units SILENT EVO3 Series.



- Scambiatori Acqua-Olio.
Water-Oil Heat exchangers.



- Scambiatori Aria-Olio Serie MOBILE.
Air-Oil Heat exchangers MOBILE Series.



- Serie HPA TK.
HPA TK Series.



- Combinati per macchine Mobili.
Combined cooler for Moving Machinery.



- Scambiatori speciali a disegno.
Special coolers by customer's drawing.



- Scambiatori Aria-olio Serie HPAM.
Air-Oil Heat exchangers HPAM Series.



- Serie HPA-2000 K.
HPA-2000 K Series.





ALTRE INFORMAZIONI | OTHER INFORMATION

EUROMAT SRL è in grado di offrire soluzioni personalizzate e di alto profilo tecnologico per qualunque tipologia di impianto oleodinamico. L'azienda è proiettata nella ricerca di innovative e specifiche soluzioni consentendo di ampliare la gamma di applicazioni nel campo dei componenti idraulici.

EUROMAT SRL can offer customized solutions with a high technological profile for any type of hydraulic system. The company searches for innovative and specific solutions allowing to expand the range of applications in the field of hydraulic components.

PRODOTTI | PRODUCTS

La gamma di prodotti EUROMAT SRL comprende: riduttori epicicloidali, ad assi paralleli, freni idraulici negativi, motori a pistoni radiali, moltiplicatori di potenza, gruppi ruota, motori orbitali e relativi supporti, pompe a ingranaggi e pompe a mano. Realizzazione di prodotti speciali e su misura. Fornitura di componenti oleodinamici per le applicazioni di diversi settori (agricolo, movimento terra, mobile, industriale, marino).

The EUROMAT product range includes planetary gearboxes, parallel axes, negative hydraulic brakes, power multipliers, radial piston motors, wheel units, orbital motors and bearing supports, gear pumps and hand pumps. Creation of special and customized products. Supply of hydraulic components for the applications of different sectors (agricultural, earth-moving, mobile, industrial, marine).



EUROMAT SRL

Via Vivaldi 151 - 41019 Soliera (MO)
Tel +39 059 567158 - Fax +39 059 8577308
www.euromatsrl.eu
info@euromatsrl.eu

PRESIDENTE | CHAIRMAN:
Alberto Macchia



FATTURATO | TURNOVER:
Euro 2.700.000,00



DIPENDENTI | EMPLOYEES:
9





➤ Riduttori per motori elettrici AGR ... WG.
Track Drives for electric motors AGR ... WG.



➤ Riduttore Ruota AGR 251 per motori a pistoni radiali.
Wheel Drive AGR 251 for radial piston motors.



➤ Riduttore ad assi paralleli R90.
Gearbox R90 with parallel shaft.



➤ Freno idraulico negativo a dischi tipo XF.
Hydraulic negative disk brake type XF.



➤ Motore orbitale tipo MMGLR.
Orbit motor type MMGLR.



➤ Motoriduttori speciali AGTR.
Special drives AGTR series.



 **F.LLI BONO SPA**
 Via dell'Economia 131 - 36100 Vicenza (VI)
 Tel +39 0444 990990
www.bonofli.it
www.linkedin.com/company/bono-spa
bono@bonofli.it

PRESIDENTE | GENERAL MANAGER:
 Alberto Bono

 **FATTURATO | TURNOVER:**
 Euro 16.000.000,00

 **DIPENDENTI | EMPLOYEES:**
 60

 **ALTRE INFORMAZIONI | OTHER INFORMATION**

Filiale | Branch:
 Via Lago di Lugano, 28, 36015 Schio VI

Le nostre divisioni tecniche (Meccatronica, Pneumatica, Oleodinamica, Alluminio e Utensileria) offrono servizi di consulenza sulle principali tecnologie combinando soluzioni tradizionali con soluzioni molto innovative.

Our technical departments (mechatronics, hydraulics, aluminium, tools) offer consultancy services on the main technologies by combining traditional and innovative solutions.

PRODOTTI | PRODUCTS

Cuscinetti e supporti - movimentazione lineare - guarnizioni, organi di trasmissione - riduttori, catene, cinghie, motori elettrici - inverter, azionamenti, utensili per asportazione truciolo, attrezzature macchine utensili, strumenti e macchine di misura, abrasivi, lubrificanti - sistemi per la gestione dei fluidi, utensili manuali, profili di alluminio - dispositivi di protezione - automazione, pneumatica - tecnica del vuoto, oleodinamica - idraulica, attrezzature per officina, elettrostrumenti - utensili pneumatici, sollevamento e trasporto, chimici e grassi, arredamento industriale antinfortunistica.

Bearings and supports - linear movement - seals, transmission components - reducers, chains, belts, electric motors - inverters, drives, tools for chip removal, machine tool equipment, measuring instruments and machines, abrasives, cooling lubricants - fluid management systems, hand tools, aluminum profiles - protection devices - automation, pneumatics - vacuum technique, hydraulics - hydraulics, workshop equipment, power tools - pneumatic tools, lifting and transport, chemicals and fats, industrial furniture, accident prevention.



➤ Quadri pneumatici con connessioni in bus di campo.
Pneumatic panels with fieldbus connections.

➤ Centralina oleodinamica per settore fonderie.
Hydraulic power unit for the foundry sector.



➤ Sistema test di automazione.
Automation system test.





H

P

M

**F.LLI TOGNELLA SPA**

Via Goito 60 - 21019 Somma Lombardo (VA)
 Tel +39 0331 988411 - Fax +39 0331 988499
 www.tognella.it
 tognella@tognella.it

AMMINISTRATORE DELEGATO | CEO:

Fabio Tognella

**FATTURATO | TURNOVER:**

Euro 9.865.000,00

**DIPENDENTI | EMPLOYEES:**

54

**ALTRE INFORMAZIONI | OTHER INFORMATION**

Certificazioni | Certifications:
 ISO 9001.

PRODOTTI | PRODUCTS

Valvole oleodinamiche e idropneumatiche di regolazione, manuali, con o senza compensazione barica, in acciaio per alte pressioni (fino a 400 bar) e in OT 58 per pressioni fino a 210 bar. Esclusori per manometri a spillo, a piastra, a pulsante. Valvole unidirezionali in linea e valvole modulari CETOP 03 e 05. Attacchi rapidi per liquidi e aria in AISI 316. Valvole di ritegno pilotate semplici, doppie e singole. Regolatori a piastra. Elettrovalvole CETOP 03 e 05. Pressostati e livellostati.

Hydraulic and hydropneumatic manual control valves, with or without baric compensation, made in carbon steel for high pressure (up to 400 bar) and OT 58 for pressures up to 210 bar. Gauge isolator needle-valves, plate and push button-valves. Check in-line flow control valves and stackable valves CETOP 03 and 05. Quick release couplings for fluids and air in stainless steel AISI 316.

Simple pilot operated check valves available in double and single version. Plate regulators. Solenoid directional control valves CETOP 03 and 05. Pressure and level switches.

- Valvola di regolazione bidirezionale AISI 316 - in linea.
In line double-acting flow control valve - AISI 316.



- Valvola di regolazione unidirezionale - in linea.
In line single-acting flow control valve.



- Valvola di regolazione unidirezionale a compensazione barica.
Single-acting pressure compensated flow control needle valve.



- Pressostato 230V - DIN 43650/A contatti SPDT - IP65.
Pressure switch - SPDT - IP65 - DIN 43650/A.



- Livellostato 1 o 2 punti di intervento.
Electromagnetic Level switch - 1 or 2 switching points.



- Pressostati per applicazioni oleodinamiche.
Pressure switch for hydraulic applications.



- CETOP 03 Valvola modulare regolazione di portata bidirez.
CETOP 03 Stackable valve double-acting flow control.



- CETOP3 Valvola modulare regolazione di pressione diretta.
CETOP3 Stackable valve direct pressure relief.



- Elettrovalvola Cetop 03 - 05.
Solenoid directional control valve CETOP 03 - 05.





ALTRE INFORMAZIONI | OTHER INFORMATION

Società all'estero | Foreign associated companies:

FAI FILTRI Canada Inc.
sales@faifiltri.ca

FAI FILTRI U.S. LLC
marketing@faifiltri.us.com

FAI FILTRI Russia
info@faifiltri.ru

FAI FILTRI Malaysia Sdn. Bhd.
faifsb@gmail.com

PRODOTTI | PRODUCTS

Dal 1976 Fai Filtri produce elementi filtranti e componenti per i settori Aftermarket, Oleodinamica, Elettroerosione, Industriale e Separazione Aria/Olio.

Since 1976, Fai Filtri has been making Filters Elements, and Components for the Aftermarket, Hydraulics, EDM, Industrial, and Air/Oil Separation.



FAI FILTRI SRL

Strada Francesca 7 - 24040 Pontirolo Nuovo (BG)

Tel +39 0363 880024 - Fax +39 0363 330177

www.faifiltri.it

faifiltri@faifiltri.it

AMMINISTRATORE DELEGATO | CEO:

Pasotto Roberto



FATTURATO | TURNOVER:

Euro 23.500.000,00



DIPENDENTI | EMPLOYEES:

102



- Serie After Market intercambiabili ai maggiori produttori di filtri e macchinari.
After Market Series interchangeable with major filter and machinery manufacturers.



- Serie SpinOn fino a 3 micron portate fino a 365 l/min.
SpinOn series, up to 3 microns, flow rates of up to 365 l/min.



- Separazione Aria/Olio serie SpinOn avvitabili e a Cestello.
Air/Oil separation, SpinOn series, and Tank-top configurations.



**FARBO SRL**

Via Cimarosa 17 - 40033 Casalecchio di Reno (BO)
 Tel +39 051 6419530 - Fax +39 051 6419522
 www.farbo.it
 info@farbo.it

AMMINISTRATORE | CHAIRMAN:

Enzo Farolfi

**FATTURATO | TURNOVER:**

Euro 5.440.000,00

**DIPENDENTI | EMPLOYEES:**

35

**ALTRE INFORMAZIONI | OTHER INFORMATION**

La struttura commerciale Farbo è diversificata a seconda delle esigenze di mercato in tutto il mondo, operando sia direttamente che tramite rivenditori e/o distributori.

Fornisce inoltre consulenza tecnica diretta per lo sviluppo dei prodotti speciali e a disegno.

Farbo commercial structure is diversified according to the market needs both in Italy and in all Europe. Farbo operates both directly and through an intermediate channel with resellers and distributors in various places. Provides direct technical advice for development of special and customized products.

PRODOTTI | PRODUCTS

Nel 1975 la FARBO inizia la sua attività producendo prevalentemente componenti speciali su commessa.

Dal 1996 certificata UNI ISO 9001:2008. FARBO produce con le più aggiornate macchine utensili CNC una vasta gamma di componenti per l'automazione pneumatica, senza mai dimenticare la propria vocazione per la prototipazione orientata alla meccanica fine e di precisione.

In 1975 FARBO starts its activity producing mostly custom-made components.

In 1996 Farbo obtains UNI ISO 9001:2008 certification.

FARBO manufactures a wide range of pneumatic automation components using the latest CNC equipment available on the market, never forgetting its own disposition toward precision mechanical prototyping.

H

P

M



- **Componenti pneumatici standard.**
Produzione di cilindri pneumatici, unità rotanti, giunti rotanti, cilindri compatti, valvole ed elettrovalvole, valvole di sicurezza, valvole a tampone per fluidi, accessori.



- **Progetto e realizzazione speciali a disegno.**
Progettazione e realizzazione di componenti speciali per applicazioni particolari; cilindri pneumatici, valvole a tampone e unità rotanti per ogni applicazione.



- **Tecnologia del vuoto per la manipolazione.**
Catalogo di componenti per la tecnologia del vuoto: ventose, portaventose, eiettori venturi, silenziatori, filtri per vuoto, sensori digitali, sensori a stato solido.



- **Standard pneumatic components.**
Manufacturing of pneumatic cylinders, rotary actuators, rotary joints, compact cylinders, valves, solenoid valves, safety valves, plug valves for fluids, accessories.

- **Design and manufacture of customized parts.**
Design and manufacture of special parts for particular applications such as: pneumatic cylinders, globe valves and rotary devices for every application.

- **Vacuum technology for industrial automation.**
Catalogue of components for vacuum suction technology: vacuum cups, vacuum cups fittings, venturi ejectors, silencers, vacuum filters, digital sensors, solid state sensors.



Faster
A HELIOS TECHNOLOGIES COMPANY

H

P

M

**FASTER SRL**

Via Ludovico Ariosto 7 - 26027 Rivolta D'Adda (CR)
Tel +39 0363 377211 - Fax +39 0363 377284
www.fastercouplings.com
info@fastercouplings.com

PRESIDENTE | GENERAL MANAGER:
Matteo Arduini



FATTURATO | TURNOVER:
Maggiore di Euro 120.000.000,00



DIPENDENTI | EMPLOYEES:
547

**ALTRE INFORMAZIONI | OTHER INFORMATION**

Nel 2018 l'azienda è entrata a far parte del gruppo Helios Technologies, una compagnia quotata in borsa (Nasdaq: HLIO) che sviluppa e produce soluzioni elettroniche e idrauliche per diversi mercati.

In 2018 Faster became part of Helios Technologies Group, a publicly traded company (NASDAQ: HLIO) that develops and manufactures hydraulic and electronic control solutions for diverse markets.

Società all'estero | Foreign associated companies:

Faster Inc (USA), Faster Hydraulics Co Ltd (China), Faster Hydraulics Pvt Ltd (India), Faster do Brasil (Brazil), Faster Germany GmbH (Germany). Local Agents in France, Eastern Europe, Japan and South East Asia.

PRODOTTI | PRODUCTS

Leader mondiale nella produzione di componenti idraulici, Faster ha progettato e prodotto più di cinquecento milioni di innesti rapidi e registrato più di cento brevetti. Il portfolio prodotti dell'azienda comprende tre aree: innesti rapidi singoli, cartucce tailor-made con innesti integrati e multi connessioni. Faster sta ulteriormente accelerando la sua crescita attraverso un intenso programma di lanci di nuovi prodotti e applicazioni.

Global leader in the production of hydraulic components, Faster has designed and manufactured over 500 million quick-release couplings and has registered more than 100 patents. The company's products portfolio comprises three product areas: individual couplings, cartridge couplings integrated in tailor-made castings, and multi connections. Faster is further accelerating its growth through an intense program of new products and applications.



➤ 3CFHF: Innesto push-pull per applicazioni agricole.
3CFHF: Push-pull coupling for agriculture.



➤ MC6: Multifaster 6 linee compatta per applicazioni agricole.
MC6: Compact 6-line Multifaster for agricultural applications.



➤ 4BM4DCPV: blocco con cartucce (applicazioni agricole).
4BM4DCPV: castings with couplings for agriculture.



➤ FHV: innesti faccia piana per settore costruzioni.
FHV: Flat face coupling for Construction Equipment.



➤ QTC: innesti per cambio automatico attrezzi (settore costruzioni).
QTC: couplings for automatic tool change (Construction Equipment).



➤ 4BD4FH: fusione per settore costruzioni.
4BD4FH: castings for construction equipment.



FILTREC SPA

Via Dei Morengli 1 - 24060 Telgate (BG)
Tel +39 035 8368001 - Fax +39 035 831925
www.filtrec.it
info@filtrec.it

PRESIDENTE | CEO:
Sergio Modena



FATTURATO | TURNOVER:
Euro 39.500.000,00



DIPENDENTI | EMPLOYEES:
170



ALTRE INFORMAZIONI | OTHER INFORMATION

Filtrec vanta una significativa presenza internazionale grazie a una rete di dodici filiali che distribuiscono in Europa, America e Asia. Oltre a numerosi distributori posizionati in aree strategiche del mondo.

Filtrec also boasts a significant international presence, thanks to a network of twelve branches across Europe, America, and Asia. In addition to numerous distributors located in strategic areas of the world.

PRODOTTI | PRODUCTS

Filtrec occupa da oltre trent'anni una posizione di eccellenza nella progettazione, produzione e distribuzione di filtri oleodinamici, dai classici elementi filtranti fino alla fornitura di filtri completi: in pressione, in aspirazione e sul ritorno per varie applicazioni. A completare la gamma una seconda divisione di filtri di processo.

Since 1978 Grices has been designing and producing a wide range of standard ISO 6020/2, 6020/1, 6022, welded, short stroke and customized hydraulic cylinders. Grices also offers its customers technical support, component kits, seal kits and an online configuration tool. In addition, on site production and testing of all products guarantees the authenticity of a ISO 9001 certified company that confirms its commitment to quality and excellence.



➤ Filtri in pressione.
In line pressure filters.



➤ Filtri sul ritorno.
Return filters.



➤ Filtri in aspirazione.
Suction filters.



➤ Elementi filtranti.
Filter elements.



➤ Gestione dei fluidi.
Fluid management.



➤ Accessori (sfiati, indicatori di livello e intasamento).
Accessories (breathers, level gauges and indicators).



GRICES
HYDRAULIC CYLINDERS



GRICES HYDRAULIC CYLINDERS SRL

Via Postale Vecchia 111 - 23857 Valgrehentino (LC)

Tel +39 0341 660290 - Fax +39 0341 660285

www.grices.it

info@grices.it

PRESIDENTE | CHAIRMAN:

Mauro Cesana



DIPENDENTI | EMPLOYEES:

35



ALTRE INFORMAZIONI | OTHER INFORMATION

- **CONFIGURATORE ONLINE:** configura il tuo cilindro, visualizza subito prezzi, disegni e tempi di consegna. Procedi con l'ordine in un click e approfitta dello sconto "web" - <http://configuratore.grices.it/>.
- **SALES NETWORK:** Grices distribuisce i propri cilindri oleodinamici standard e speciali in tutto il mondo.
- **ONLINE CONFIGURATOR:** *configure your cylinder, check immediately prices, drawings and delivery times. Click to proceed with the order and take advantage of the "web" discount - <http://configuratore.grices.it/>.*
- **SALES NETWORK:** *Grices distributes its standard and special hydraulic cylinders worldwide.*

PRODOTTI | PRODUCTS

Da 1978 Grices progetta e produce una vasta gamma di cilindri standard ISO 6020/2, 6020/1, 6022, saldati, corsa breve e speciali, offrendo ai clienti anche supporto tecnico. Kit componenti, guarnizioni e un configuratore online gratuito completano l'offerta. La produzione in loco e il test su tutti i prodotti garantiscono inoltre l'autenticità di un'azienda certificata ISO 9001 che conferma il suo impegno per la qualità e l'eccellenza.

Since 1978 Grices has been designing and producing a wide range of standard ISO 6020/2, 6020/1, 6022, welded, short stroke and customized hydraulic cylinders. Grices also offers its customers technical support, component kits, seal kits and an online configuration tool. In addition, on site production and testing of all products guarantees the authenticity of a ISO 9001 certified company that confirms its commitment to quality and excellence.

- Cilindri idraulici ISO6020/2, DIN24554.
Hydraulic cylinders ISO6020/2, DIN24554.

CH



- Cilindri idraulici magnetici ISO6020/2, DIN24554.
Hydraulic cylinders with sensor switches ISO6020/2, DIN24554.

CHM



- Servocilindri con trasduttore ISO6020/2, DIN24554.
Servocylinders with trasducer ISO6020/2, DIN24554.

CHT



- Cilindri idraulici ISO6020/1, anche con trasduttore (CAT).
Hydraulic cylinders ISO6020/1, also with trasducer (CAT).

CA



- Configuratore online per cilindri, disegni, offerte e ordini.
Online configurator for cylinders, drawings, offers and orders.



- Cilindri idraulici ISO6022, anche con trasduttore (CCT).
Hydraulic cylinders ISO ISO6022, also with trasducer (CCT).

CC



- Cilindri idraulici saldati - Alesaggi da 40 a 350 mm.
Welded hydraulic cylinders - Bore from 40 to 350 mm.

CL



- Cilindri a corsa breve magnetici - Alesaggi da 25 a 100 mm.
Magnetic short stroke cylinders - Bore from 25 to 100.

CB



- Kit componenti e accessori.
Components and seals kits.

KIT



ALTRE INFORMAZIONI | OTHER INFORMATION

Filiale | Branch:
Via Stelvio, 50 - 25038 Rovato (BS)
Tel +39 030 7704916

PRODOTTI | PRODUCTS

Specializzati nella realizzazione di centrali/minicentraline oleodinamiche, manifolds, valvole speciali, per l'impiego in diversi campi industriali. Ogni sistema viene collaudato da personale specializzato.

Ampio magazzino per fornitura di varie tipologie di: pompe, motori, cilindri, valvole, basi. Progettazione e realizzazione di blocchi integrati. Ampia gamma di accessori a corredo impianti.

Specialized in manufacturing hydraulic power units, manifolds, special valves, for use in various industrial fields.

All system is tested by qualified personnel. Large inventory in stock for the supply and ordered: pumps, motors, cylinders, valves, modular bases.

Design and implementing of integrated blocks. Wide range of accessories.



GTA LOMBARDIA SRL
Via S. Maria 104 - 20093 Cologno Monzese (MI)
Tel +39 02 27300668
www.gtalombardia.it
info@gtalombardia.it

H

P

M

- Pompe a portata fissa e variabile.
Variable and fixed displacement.



- Componentistica CETOP.
CETOP elements.



- Valvole proporzionali ed elettronica.
Proportional valves and electronics.



- Mini Centraline.
Modular power units.



- Centrali oleod., gruppi di filtraggio, travaso e lubrificazione.
Hydr. power pack, oil filling, filtering unit and lubrication.



- Componenti per applicazioni speciali.
Components for special applications.



- Blocchi idraulici.
Hydraulic manifolds.



- Progettazione CAD 3D.
3D CAD design.

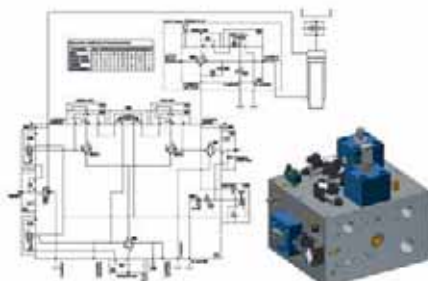

- Accessori.
Accessories.





 **ALTRE INFORMAZIONI** | OTHER INFORMATION

Filiale: Modena (MO)
Via Raimondo dalla Costa, 220 C/D
41122 Modena (MO)
Tel +39 059 86 30 986
commerciale.modena@hiflexitalia.com

HI-FLEX ITALIA è distributore esclusivo per il mercato Italiano dei prodotti:

- Dunlop Hiflex
- Techmaflex
- DNP
- Power Team

www.linkedin.com/company/hi-flex-italia-srl

PRODOTTI | PRODUCTS

Fondata nel 1994 ad Arezzo, HI-FLEX ITALIA è diventata in pochi anni un punto di riferimento nel settore dei tubi e dei raccordi per le applicazioni ad alta ed altissima pressione.

Nel 2021 l'espansione aziendale è continuata con l'apertura della filiale di Modena Torrazzi.

La preparazione tecnica della forza vendita, l'affidabilità del servizio clienti e la prontezza nella gestione degli ordini hanno fatto meritare ad HI-FLEX ITALIA la fiducia dei migliori costruttori mondiali di soluzioni per l'oleodinamica, quali: il marchio storico Dunlop Hiflex, la francese Techmaflex, l'italiana DNP, delle quali ne curiamo la distribuzione in esclusiva per il mercato italiano e l'americana SPX Power Team per la quale siamo diventati un importante caposaldo nello scenario nazionale.



HI-FLEX ITALIA SRL

Sede: Poppi (AR)
Via Romena 12, Loc. Porrena - 52014 Poppi (AR)
Tel +39 0575 560920 - Fax +39 0575 560875
www.hiflexitalia.com
commerciale@hiflexitalia.com

AMMINISTRATORE | MANAGING DIRECTOR:

Amedeo Asmodei



DIPENDENTI | EMPLOYEES:

55



- **DUNLOP HIFLEX.** Tubi Oleodinamici: Greenline, Bio-extra, Powerflex, Waterblast, Tuflex, Firesafe, Termoplastico.



- **DUNLOP HIFLEX.** Raccordi Oleodinamici: New Powertrak, Supertrak e Interlock.



- **TECHMAFLEX.** Attrezzature per l'assemblaggio di tubi e raccordi: presse, taglierine e banchi collaudo.



- **DNP.**
Innesti rapidi per impianti oleodinamici.



- **DIN 2353.** Semplicità di montaggio, tenuta ermetica e alta resistenza alla pressione.



- **TEFLON®.** Tubi a parete liscia e convoluta per bassa, media e alta pressione.



- **ACCESSORI.** Rondelle di tenuta, giunti girevoli, ugelli e proiettili, microtubi e miniprese.



- **TUBI FLESSIBILI METALLICI:** a parete semplice, doppia, aggraftati - COMPENSATORI DI DILATAZIONE.



- **SPX POWER TEAM.** Strumenti e accessori ad alta pressione per sollevamento, tensionamento e serraggio.





HYDRECO
a member of **DAIKIN** group



HYDRECO HYDRAULICS ITALIA SRL

Via dell'Artigianato 580 - 41058 Vignola (MO)
Tel +39 059 7700411 - Fax +39 059 7700425
www.hydreco.com
sales-it@hydreco.com

DIRETTORE | *MANAGING DIRECTOR:*
Michele Guiati



FATTURATO | *TURNOVER:*
Euro 6.500.000,00



DIPENDENTI | *EMPLOYEES:*
37



ALTRE INFORMAZIONI | *OTHER INFORMATION*

Hydreco Hydraulics Italia, società Italiana del gruppo Hydreco, presente in Inghilterra, Norvegia, Germania, USA, India, Cina, Australia.

Hydreco Hydraulics Italia, the Italian branch of the Hydreco group, with presence in UK, Norway, Germany, USA, India, China, Australia.

PRODOTTI | *PRODUCTS*

HYDRECO HYDRAULICS fornisce un'ampia gamma di soluzioni per la regolazione della potenza fluida e meccanica.

- Pompe e motori ad ingranaggi.
- Valvole di controllo direzionale e bancabili.
- Valvole a cartuccia e manifold.
- Telecomandi proporzionali idraulici ed elettrici.
- Impugnature multifunzione.
- Servovalvole oleoidrauliche.
- Schede elettroniche di controllo.
- Sistemi Can-bus.
- Cilindri oleoidraulici
- Riduttori e motoriduttori.
- Prese di forza.

HYDRECO HYDRAULICS supplies a wide range of solutions for the control of the fluid and mechanical power.

- Gear pumps and motors.
- Directional and bankable control valves.
- Cartridge valves and manifold.
- Proportional hydraulic and electric joysticks.
- Multifunction ergonomic handles.
- Hydraulic servovalves.
- Electronic control cards.
- Can-bus systems.
- Hydraulic cylinder.
- Gearboxes and gearedmotors.
- PTO.

Certificazioni | *Certifications:*

Azienda certificata ISO9001:2015



➤ Pompe ad ingranaggi in ghisa, 4-248cc, max 350 bar.
Hydraulics cast iron gear pumps, 4-248cc, max 350 bar.



➤ Telecomandi proporzionali idraulici.
Hydraulic proportional pilot valves.



➤ Pompe ad ingranaggi in alluminio, 1-63cc, max 260 bar.
Hydraulics aluminium gear pumps, 1-63cc, max 260 bar.



➤ Prese di forza a montaggio posteriore e laterale.
Rear and side mounting PTO's.



➤ Valvole di controllo componibili on-off e/o proporzionali.
Bankable valves, on-off and/or proportional.



➤ Sistemi di controllo con joystick proporzionali, CAN-bus e impugnature multifunzione.
Control systems with proportional joysticks, CAN-bus and multifunction ergonomic handles.



Hydronit

H

P

M

**HYDRONIT SRL**

Via Pastrengo 62 - 20814 Varedo (MB)
Tel +39 0362 1841210 - Fax +39 0362 1841214
www.hydronit.com
sales@hydronit.com

AMMINISTRATORE | MANAGING DIRECTOR:
Ing. Andrea Gambusera



FATTURATO | TURNOVER:
Euro 10.000.000,00



DIPENDENTI | EMPLOYEES:
30

**ALTRE INFORMAZIONI | OTHER INFORMATION**

Hydronit distribuisce i suoi prodotti in oltre 70 paesi nel mondo tramite una rete di agenti, distributori e aziende associate

Hydronit distribute their products in over 70 countries in the world through agents, distributors and associated companies.

Aziende associate | Associated companies:
Hydronit Americas Inc. - USA
info@hydronitamericas.com

MicroHy Electro-Hydraulic Systems (Suzhou) Co., Ltd. - Hydronit Asia Trading Co., Ltd - China
info@microhy.com.cn

Hydronit UK Ltd - UK
uk@hydronit.com

PRODOTTI | PRODUCTS
Centrale Oleodinamica Smart

- Controllore digitale programmabile
- Controllo proporzionale assi, portata e pressione
- Due linee CAN, WiFi, Ethernet, Hart
- Architettura di sicurezza SIL2
- Ambiente di sviluppo IEC 61131
- Alimentazione: 6÷32V DC
- Consumo: ≤ 200mA
- T di utilizzo: -40÷+85°C
- Sigillo di eccellenza UE

Centrali oleodinamiche AC & DC serie COMPACT (0,2÷25 l/min, 0,15÷7,5 kW), serie MICRO (0,2÷6 l/min, 0,15÷2,2 kW) ed elettropompe DC (0,15÷5,5 kW).

Smart Power Unit

- Programmable digital controller
- Axis and PQ proportional control
- Double CAN bus, WiFi, Ethernet, Hart
- Safety Architecture SIL2
- IEC 61131 compliant IDE
- Supply: 6÷32V DC
- Consumption: ≤ 200mA
- Operating T: -40÷+85°C
- EU Commission Seal of Excellence

AC & DC hydraulic power packs COMPACT series (0.2÷25 l/min, 0.15÷7.5 kW), MICRO (0.2÷6 l/min, 0.15÷2.2 kW) and DC electropumps (0.15÷5.5 kW).



▶ Lavorazioni robotizzate su CNC 5 assi.
5 axis CNC robotized machining.

▶ Centralina smart per l'industria 4.0: programmabile con ambiente di sviluppo SIL2.
Smart Power Unit: SIL2 programmable digital controlled.

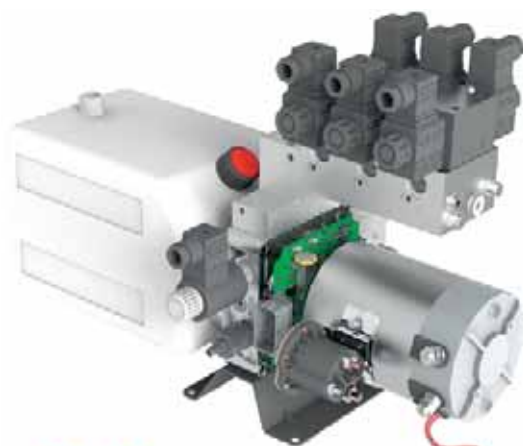

XDRAULICS

▶ Gamma modulare di centraline serie Compact - Micro ed elettropompe per applicazioni mobili, industriali e marine.
Modular range of Compact - Micro power units and DC Electropumps for mobile, industrial and marine applications.





ALTRE INFORMAZIONI | OTHER INFORMATION

Konfit Italia S.r.l. a socio unico copre capillarmente il mercato europeo e serve clienti in oltre 40 paesi in tutto il mondo.

Konfit Italia S.r.l. a socio unico covers the European market extensively and serves customers in more than 40 countries worldwide.

PRODOTTI | PRODUCTS

Raccordi ad innesto rapido in ottone, ottone alimentare, tecnopolimero, acciaio INOX AISI 316, giunti universali, dosatori di flusso, gruppi FRL, silenziatori, manometri e vuotometri, valvole, tubi plastici alimentari ed industriali, ricambi e accessori per compressori, raccordi alimentari ed industriali, impianti di distribuzione aria a parete, ancoraggi per cilindri, lame d'aria e ugelli.

Push-in fittings made of brass, food grade brass, technopolymer, AISI 316 stainless steel, universal couplings, flow manifolds, FRL units, silencers, pressure gauges and vacuum gauges, valves, food and industrial plastic hoses, spare parts and accessories for compressors, food grade and industrial couplings, wall-mounted air distribution systems, cylinder anchors, air blades and nozzles.



KONFIT ITALIA SRL a socio unico
Via Cagnaghe 10/Q - 25065 Lumezzane (BS)
Tel +39 030 8972167
www.konfit.it
info@konfit.it

AMMINISTRATORE | CEO:
Angelo Zani

€ FATTURATO | TURNOVER:
Euro 7.700.000,00

👤 DIPENDENTI | EMPLOYEES:
35

H
P
M

- Raccordi ad innesto rapido in polimero.
Plastic push-in fittings.



- Raccordi e dosatori di flusso in polimero.
Plastic fittings and flow regulators.



- Raccordi rapidi e dosatori di flusso in ottone.
Brass push-in fittings and flow regulators.



- Raccordi automatici INOX, microfusi e standard.
INOX push-in, microcast and standard fittings.



- Raccordi standard, dosatori flusso, manometri INOX.
INOX standard fittings, flow regulators, gauges.



- Valvole, raccordi a saldare, flange, silenziatori.
INOX valves, welding fittings, flanges, silencers.



- Giunti universali e di sicurezza in ottone.
Brass universal couplings with safety.



- Raccordi Camlock INOX, Ottone, Alluminio e PP.
Camlock fittings INOX, Brass, Aluminium and PP.



- Distribuzione a parete e accessoriistica.
Air Wall distribution system and accessories.



**LEONARDO SPA**

Sede Legale: Piazza Monte Grappa, 4
00195 Roma
Tel +39 06 324731 - Fax +39 06 3208621
www.leonardo.com

AMMINISTRATORE DELEGATO | CEO:

Roberto Cingolani

**DIPENDENTI | EMPLOYEES:**

Più di 50.000

**ALTRE INFORMAZIONI | OTHER INFORMATION**

Leonardo è uno tra i principali protagonisti mondiali nel settore dell'aerospazio, difesa e sicurezza. Tramite la Divisione Elicotteri realizza progettazione, sviluppo, produzione, supporto ai clienti e commercializzazione di un'ampia gamma di elicotteri.

Leonardo is one of the world's major players in Aerospace, Defence and Security. Through the Helicopters Division, it performs research, design, development, production, customer support and marketing of an extensive range of helicopters.

PRODOTTI | PRODUCTS

Il Centro di Eccellenza per le trasmissioni di potenza e componenti meccanici riveste un ruolo strategico per la Divisione ed è dedicato alla produzione di trasmissioni e componenti metallici per la testa del rotore, all'assemblaggio delle trasmissioni e delle teste rotore nonché alle attività di riparazione e revisione di questi componenti. Il Centro di Eccellenza è responsabile di tutte le attività connesse svolte nei quattro siti di Cascina Costa, Frosinone e Benevento, in Italia, e Yeovil, in Regno Unito.

The Transmission and Mechanical Parts Centre of Excellence plays a key role for the Division and is responsible for manufacture of transmissions, drive systems and metallic rotor head components, the assembly of gearboxes and rotor heads and repair and overhaul of all these components. The Centre of Excellence encompass all the related activities across four site: Cascina Costa, Frosinone and Benevento, in Italy, and Yeovil, in the UK.



➤ Ingranaggi di una trasmissione per elicottero.
Gears of a helicopter transmission.

➤ AW139 law enforcement.



➤ AW169 EMS.





PRODOTTI | PRODUCTS

Riduttori speciali di velocità per applicazione industriale, progettazione e re-engineering di riduttori speciali e standard, revisione e manutenzione riduttori multimarca, analisi predittive, costruzione organi di trasmissione: ingranaggi cilindrici e conici, giunti, allunghe, martinetti meccanici, cuscinetti a catalogo e speciali, parti di ricambio a disegno e a catalogo, ricambi impianti oleodinamici.

Special gearboxes for industrial applications, engineering and reverse engineering of special and standard gearboxes, maintenance and revamping of gearboxes (all brands), predictive analytics, manufacturing power transmissions as gears, couplings, cardan shafts, pulleys, screwjacks, roller and special bearings, mechanical spare parts to drawing and spare parts for hydraulic systems.

Certificazioni | Certifications:

EN ISO 9001:2015 e ISO 45001:2018



LINK INTERNATIONAL SRL

Via Belvedere 26/28 - 20862 Arcore (MB)
Tel +39 039 2268758 - Fax +39 039 2267494
www.linkinternational.it
info@linkinternational.it

AMMINISTRATORE | MANAGING DIRECTOR:

Elisa Brescianini



FATTURATO | TURNOVER:

Euro 3.500.000,00



DIPENDENTI | EMPLOYEES:

8



- Riduttore di sollevamento speciale RC125 AP con indicatore di posizione.
Special lifting gearbox RC125 AP with position indicator.



- Riduttore assi paralleli AP1060 treno sbozzatore laminatoio tubi seamless (32 Ton.).
Parallel shafts gearbox AP1060 for seamless pipe edger stand (32 Ton.).



- Riduttori ad assi ortogonali AOQ205 comando colata continua billette.
Bevel Shaft gearboxes AOQ205 continuous cast drive for billet caster.





 **MARZOCCHI POMPE SPA**
Via A. Grazia 2 - 40069 Zola Predosa (BO)
Tel +39 051 613 7511 - Fax +39 051 592 083
www.marzocchipompe.com

CEO | CEO:
Gabriele Bonfiglioli

DIRETTORE COMMERCIALE | SALES MANAGER:
Damiano Roncaglia

 **FATTURATO | TURNOVER:**
Euro 49.746.000,00

 **DIPENDENTI | EMPLOYEES:**
275

 **ALTRE INFORMAZIONI | OTHER INFORMATION**

MARZOCCHI POMPE SPA
Stabilimento Marzocchi di Casalecchio
Via 63° Brigata Bolero 15
40033 Casalecchio Di Reno (BO)

MARZOCCHI PUMPS USA CORP.
1355 BOWES ROAD - ELGIN, IL 60123
Tel Office 847 923 9910
Tel Toll free 800 924 5404
pumps@marzocchipumpsusa.com

MARZOCCHI SYMBRIDGE HYDRAULIC (SHANGAI) CO. LTD.
Room F, 21 F/L, Fei-Zhou
International Plaza, n. 899, Ling-Ling Road
Shanghai 200030 - China
Tel +86 216 301 29 89
info@marzocchisym.com
www.marzocchipompe.com

PRODOTTI | PRODUCTS

Le pompe e i motori ad ingranaggi in alluminio (AL) sono la soluzione ideale per una vasta gamma di applicazioni. Le vaste configurazioni di alberi, porte e flange rendono le pompe e i motori Marzocchi molto versatili. I prodotti in alluminio sono disponibili anche in versione pompe modulari e a ingombro ridotto (pompe corte).

Aluminum (AL) gear pumps and motors are the ideal solution for many applications. The wide configurations of shafts, ports and flanges give this product line a great versatility. The aluminum products are also available in modular version pumps and reduced size (short pump).



➤ K1P/EK1P: immerse o esterne perfette per le centraline nel Mobile.
Submerged or external, perfect for the Mobile power-packs apps.

➤ 0,25-0,5: pompe ad alta performance per micro-centraline.
High performance pumps integrated into micro power packs.



➤ 1P: ideali per il sett. industriale grazie alla loro affidabilità.
Ideal for the industrial sector thanks to their reliability.



➤ ALP: pompe in alluminio per pressioni medio-alte.
Pumps in full aluminum for medium-to-high press.



➤ GHP: per alte press. e sett. mobile, agricolo e delle costruzioni.
For high-press. in Mobile, Agricultural & Construction Apps.



➤ ALM: Marzocchi Top Gear Motor.



➤ GHM: motore Robusto ideale per il Mobile.
Strong Motor perfect for Mobile Applications.



➤ ALP-GHP: flessibili, per le più svariate esigenze.
Flexible, for all requirements.



➤ ALPC/GHPS: corte per il Mobile.
Short Pumps for Mobile.



➤ HI-LO: dove servono 2 stadi diversi.
HI-LO: where 2 Different specs are needed.



➤ T-SYSTEM: per app. con carichi radiali e assiali.
To use in presence of radial and axial loads.



➤ E05: pompe progettate per applicazioni Automotive.
E05: pumps designed for Automotive applications.



- VM-VN: con valvole di massima e anticavitazione.
With anti-cavitation & Relief valves



- LS: dividono portata in primaria e secondaria.
Pumps splitting the flow-rate into 2 different branches.



- VE: con Valvola di massima elettro-proporzionale.
Pumps and Motors with electro-proportional relief valve.



- FTP: pompa a rotore elicoidale per applicazioni low-press.
Pump with helical rotor for low-press. applications.



- Range Marzocchi Pompe.
Marzocchi Range Pumps.



- Accessori: Raccordi e Giunti in diverse configurazioni.
Accessories: Several Couplings and Elbows are available.



- ELIKA2: da 7 a 35 cm³/giro di cilindrata.
Displacement from 7 to 35 cm³/rev.



- ELIKA3: da 20,4 a 87,1 cm³/giro.
Displacement from 20,4 to 87,1 cm³/rev.



- ELIKA4: da 86,5 a 199,8 cm³/giro.
Displacement from 86,5 to 199,8 cm³/rev.





ALTRE INFORMAZIONI | OTHER INFORMATION

Filiali Italiane | *Italian Branches:*
Bari, Bergamo, Bologna, Brescia, Cremona,
Lecco, Mantova, Milano, Modena, Novara,
Parma, Prato, Rimini, Torino, Treviso, Varese,
Verona, Vicenza.

Società all'estero | *Foreign Associated companies:*

Australia, Austria, Belgio, Brasile, Cina,
Danimarca, Finlandia, Francia, Germania,
India, Indonesia, Malesia, Olanda, Polonia,
Portogallo, Rep. Ceca, Romania, Russia,
Singapore, Spagna, Sud Africa, Svezia, Svizzera,
Thailandia, Ucraina, UK, USA, Vietnam.

PRODOTTI | PRODUCTS

La gamma Metal Work si articola su cinque linee principali: attuatori pneumatici ed elettrici, manipolazione, valvole ed elettrovalvole, gruppi trattamento aria, raccordi ed accessori impianti.

The Metal Work range is divided into five main lines: pneumatic and electric actuators, handling, valves and solenoid valves, FRL units, fittings and plant accessories.



METAL WORK SPA

Via a. Segni 5/7/9 - 25062 Concesio (BS)
Tel +39 030 218711 - Fax +39 030 2180569
www.metalwork.it
metalwork@metalwork.it

AMMINISTRATORE | *MANAGING DIRECTOR:*

Daniele Marconi



FATTURATO | *TURNOVER:*

Euro 245.000.000,00



DIPENDENTI | *EMPLOYEES:*

oltre 1.000





➤ Attuatori.
Actuators.



➤ Gruppi trattamento aria.
FRL units.



➤ Valvole.
Valves.



➤ Raccordi.
Fittings.



➤ Accessori.
Accessories.



➤ Manipolazione.
Handling.



MISELLI SRL
Via Caduti delle Reggiane 46/48 -
42122 Reggio Nell'Emilia (RE)
Tel. +39 0522 550291 - Fax. +39 0522 331140
www.misellisrl.com - info@misellisrl.com

PRESIDENTE | GENERAL MANAGER:
Claudio Miselli

€ FATTURATO | TURNOVER:
Euro 3.900.000,00

👥 DIPENDENTI | EMPLOYEES:
26

ALTRE INFORMAZIONI | OTHER INFORMATION

Presenti nel mercato dal 1959 e certificati ISO 9001 dal 2007, esportiamo in tutto il mondo attraverso una rete capillare di distributori presenti non solo in Europa ma anche in Canada, Sud Africa, Australia e negli Stati Uniti.

With more than 60 years of experience and certified ISO 9001 since 2007, we export all over the world through a widespread network of distributors present not only in Europe but also in Canada, South Africa, Australia and United States.

PRODOTTI | PRODUCTS

Offriamo una gamma completa di accessori per serbatoi ed applicazioni oleodinamiche. Siamo specializzati nella produzione di articoli in plastica e in metallo per fornire ai nostri clienti un portafoglio prodotti che possa soddisfare al massimo le loro esigenze.

- Indicatori di livello olio verticali e filettati.
- Tappi di riempimento e sfato.
- Tappi di chiusura, carico e scarico.
- Protezioni in plastica.

We offers a complete range of accessories for tanks and hydraulic applications. We are specialized in the production of plastic and metal parts in order to provide to our customers a product portfolio that can fully satisfy their needs.

- Vertical and threaded oil level indicators.
- Filler breathers.
- Closing, filling and draining plugs.
- Plastic protections.

- Indicatori di livello olio.
Oil level indicators.



- Tappi di chiusura e sfiato.
Closing plugs and filler breathers.



- Tappi e sfiati metallici.
Metal plugs and breathers.





MITA
OLEODINAMICA S.p.A.



MITA OLEODINAMICA SPA

Via Carlo Cipolla 12 - 37039 Tregnago (VR)
Tel +39 045 7808900 - Fax +39 045 7808162
www.mitaoleodinamica.com
info@mitaoleodinamica.com

DIRETTORE GENERALE | GENERAL MANAGER:

Ing. Roberto Zamboni



FATTURATO | TURNOVER:

Euro 64.000.000,00



DIPENDENTI | EMPLOYEES:

160



ALTRE INFORMAZIONI | OTHER INFORMATION

Plant 2:

Via Carlo Cipolla, 26
37039 Tregnago (VR) - Italy

Società consociate | Sister companies:

- CBM S.p.A.
- Mita India Pvt.Ltd.
- Mita Hydraulics China Pvt.Ltd.
- CBM Polska.

PRODOTTI | PRODUCTS

Sistemi di sollevamento completi a controllo meccanico e elettronico per trattori. Valvole direzionali a comando meccanico e elettronico fino a 120l/min, regolatori di flusso, valvole check, di massima e speciali, distributori di comando per trattori. Gamma completa di cilindri oleodinamici a semplice e doppio effetto anche retroazionati. Terzi punti idraulici per trattori di categoria da 1 a 4. Sistemi di controllo remoto meccanici ed elettronici.

Complete mechanical and electronic lifting systems for tractors. Mechanical and electronic controlled directional valves up to 120l/min, flow regulators, check valves, relief valves, special valves, control valves for tractors. Full range of single and double acting hydraulic cylinders, also with feedback. Hydraulic third points for tractors of categories 1 to 4. Mechanical and electronic remote control systems.



➤ Valvole direzionali fino a 120l/min.
Directional valves up to 120l/min.



➤ Cilindri oleodinamici a semplice e doppio effetto.
Single and double acting hydraulic cylinders.



➤ Sistemi di sollevamento completi (meccanici).
Complete lifting systems (mechanical).



➤ Valvole monoblocco e speciali.
Monobloc and special valves.



➤ Terzi punti idraulici per trattori cat.1-4.
Hydraulic third points for tractors cat.1-4.



➤ Sistemi di sollevamento completi (elettronici).
Complete lifting systems (electronic).

**NORGREN SRL**

Via Roma 108 - 20051 Cassina de' Pecchi (MI)
Tel +39 02 49410696
www.norgren.com
italy@imi-precision.com

AMMINISTRATORE | MANAGING DIRECTOR:

Eduard Camps

**FATTURATO | TURNOVER:**

Euro 20.000.000,00

**DIPENDENTI | EMPLOYEES:**

37

**ALTRE INFORMAZIONI | OTHER INFORMATION****Società all'estero | Foreign associated companies:**

Australia, Austria, Belgio, Brasile, Cina, Danimarca, Finlandia, Francia, Germania, India, Indonesia, Irlanda, Italia, Giappone, Malesia, Messico, Norvegia, Nuova Zelanda, Paesi Bassi, Polonia, Regno Unito, Repubblica Ceca, Romania, Singapore, Slovenia, Spagna, Svezia, Svizzera, Taiwan, Thailandia, USA, Ungheria.

PRODOTTI | PRODUCTS

Norgren è una multinazionale che fa parte del gruppo IMI plc e vanta una lunga storia nella creazione di soluzioni ingegneristiche innovative nei settori del controllo del movimento di precisione e della tecnologia dei fluidi.

La gamma dei prodotti Norgren comprende: Trattamento Aria, Attuatori pneumatici, Electric Motion, Valvole ed Isole di Valvole, Pressostati e Sensori, Raccordi, Tubi, Accessori e Prodotti per il Vuoto.

Norgren, part of IMI plc, has a proud history and proven track record of creating innovative engineering solutions in the fields of precise motion control and fluid technology.

The Norgren product range includes: Air Preparation, Pneumatic Actuators, Electric Motion, Valves and Valve Islands, Pressure Switches and Sensors, Fittings, Tubing & Accessories and Vacuum Products.

H

P

M



➤ Consolidata Gamma Trattamento Aria.
Well-Established Air Preparation Range.



➤ Ampia Gamma di Attuatori Pneumatici.
A Vast Array of Pneumatic Actuators.



➤ Soluzioni Electric Motion ad alte prestazioni.
High Performance Electric Motion Solutions.



➤ Gamma Completa di Valvole ed Isole di Valvole.
Complete Range of Valves and Valve Islands.



➤ Pressostati e Sensori intelligenti.
Intelligent Pressure Switches and Sensors.



➤ Raccordi, Tubi e Accessori.
Fittings, Tubing and Accessories.



 **NR DI NISOLI SRL con unico socio**
Via Treviglio 9 - 24053 Brignano Gera D'Adda (BG)
Tel +39 0363 814010
www.nrnisoli.com
info@nrnisoli.com

AMMINISTRATORE | MANAGING DIRECTOR:
Nisoli Alessandro

 **DIPENDENTI | EMPLOYEES:**
14

 **ALTRE INFORMAZIONI | OTHER INFORMATION**

Unità produttiva | Productive unit:
Brignano Gera d'Adda (BG), Italy

Società all'estero | Foreign associated companies:
U.S.A.: NR PNEUMATICS USA, CORP.
Headquarters: Brooklyn, New York, 11201
Warehouse: Dayton, OH

H

P

M

PRODOTTI | PRODUCTS

Produciamo fissaggi per cilindri pneumatici a norma e customizzati dal d.8 al d.320:

- A norme ISO 15552-VDMA (acciaio, alluminio e inox).
- A norme ISO 6432 per microcilindri (acciaio e inox), per cilindri compatti (acciaio e alluminio).
- A norme CNOMO (acciaio e alluminio).
- A norme CETOP (acciaio e alluminio).
- A norme ISO 6431 (alluminio).
- A norme NFPA.

We produce mounting parts for pneumatic cylinders from diameter 8 to 320:

- *To ISO 15552-VDMA Norm (steel, aluminium and stainless steel).*
- *To ISO 6432 for Mini-cylinders (steel and stainless steel) and for compact cylinders (steel and aluminium).*
- *To CNOMO Norm (steel and aluminium).*
- *To CETOP Norm (steel and aluminium).*
- *To ISO 6431 Norm (aluminium).*
- *To NFPA Norm.*



➤ Cerniera femmina MP2 ISO 15552 in acciaio zincato.
Female Hinge MP2 ISO 15552 Zinc-plated steel.

➤ Gamma dei prodotti.
Product range.



➤ Cerniera maschio MP4 ISO 15552 in alluminio con speciale trattamento di nichelatura.
Male Hinge MP4 ISO 15552 nickel-plated aluminium.





H

P

M

**OILCOMP SRL**

Via Barchetta 185/187 - 41123 Modena (MO)
Tel +39 059 330059 - Fax +39 059 826828
www.oilcomp.it
info@oilcomp.it

AMMINISTRATORE | MANAGING DIRECTOR:

Marco Bellotti

**FATTURATO | TURNOVER:**

Euro 2.200.000,00

**DIPENDENTI | EMPLOYEES:**

18

**ALTRE INFORMAZIONI | OTHER INFORMATION**

OILCOMP srl è specializzata nella progettazione e nella produzione di valvole e componenti oleodinamici per l'industria, con soluzioni efficaci supportate da una gamma di oltre 11.000 prodotti.

OILCOMP srl specialises in designing and manufacturing valves and hydraulic component parts for the industrial sector, with effective solutions supported by a range of over 11.000 products.

PRODOTTI | PRODUCTS

La gamma di produzione è caratterizzata da valvole a cartuccia a comando elettrico o idraulico per portate da 3 a 380 l/min e pressione di esercizio fino a 35 Mpa.

Hymo Valve System è la sintesi della filosofia di OILCOMP: un sistema modulare brevettato per la combinazione di cartucce elettriche e idrauliche per realizzare le più svariate combinazioni circuitali in base alle esigenze del cliente.

The production range is characterized by electrically or hydraulically operated cartridge valves for flow rates from 3 to 380 l/min and operating pressure up to 35 Mpa.

Hymo Valve System is the synthesis of the OILCOMP philosophy: a patented modular system for the combination of electric and hydraulic cartridges, to create the most varied circuit combinations based on customer needs.

➤ **Blocco multifunzione modulare personalizzabile Hymo Valve System.**
Multi function hydraulic custom block Hymo Valve System.

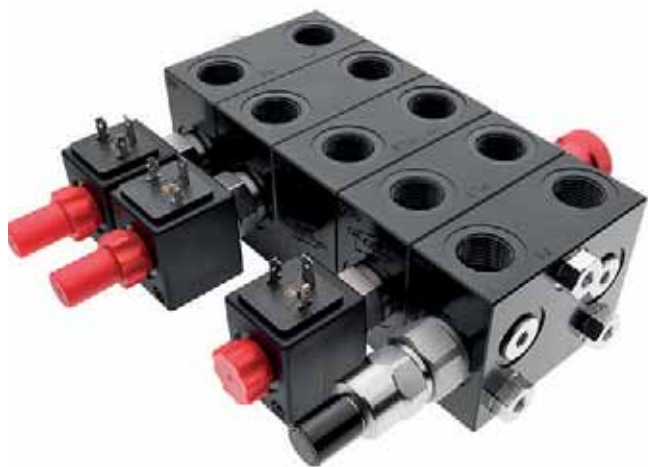

➤ **Valvola controllo rotazione per motori idraulici.**
Slew drive control valve to fit on hydraulic motors.





H

P

M

**OLEODINAMICA GECO SRL**

Via Asti 16 - 10044 Pianezza (TO)

Tel +39 011 9671875 - Fax +39 011 9672164

www.oleodinamicageco.cominfo@oleodinamicageco.com**PRESIDENTE | CHAIRMAN:**

Dr. Manlio Colombo

**ALTRE INFORMAZIONI | OTHER INFORMATION**

Presenza globale tramite distributori in Algeria, Australia, Austria, Belgio, Canada, Danimarca, Finlandia, Francia, Germania, Grecia, Olanda, Hong Kong, Irlanda, Israele, Lituania, Norvegia, Polonia, Russia, Slovacchia, Spagna, Svezia, Svizzera, Taiwan, Tunisia, Turchia, Inghilterra, Usa.

Worldwide presence with representatives in Algeria, Australia, Austria, Belgium, Canada, Denmark, Finland, France, Germany, Greece, Holland, Hong Kong, Ireland, Israel, Lithuania, Norway, Poland, Russia, Slovakia, Spain, Sweden, Switzerland, Taiwan, Tunisia, Turkey, United Kingdom, Usa.

PRODOTTI | PRODUCTS

La nostra azienda da 60 anni opera nel settore della oleodinamica.

Investendo in R&D abbiamo ottenuto 5 brevetti e 2 premi internazionali novità.

La produzione si divide in due famiglie: motori a pistoni assiali su 3 linee di prodotto (H, K, SF) in 500 modelli e motori orbitali su 7 linee di prodotto (OFM, OFP, OFR, OFH, OFS, OFT, OFV) in 1500 modelli destinati ad applicazioni gravose nel settore industriale, mobile, navale o agricolo.

Our company from 60 years operates in the field of the hydraulics components. Investing in R&D we have obtained 5 licences and 2 international innovation prizes. Our production differs in two families: axial pistons motors with 3 lines of product (H, K, SF) for 500 models and orbital motors with 7 lines of products (OFM, OFP, OFR, OFH, OFS, OFT, OFV) for 1500 models for heavy applications in industrial, mobile, naval and agricultural field.

- Motori a pistoni assiali, cilindrata fissa, 10-2000 rpm, 400 BAR.
Axial pistons motor, fixed displacement, 10-2000 rpm, 400 BAR.



- Sezione motori HF.
HF motor section.



- Motori a pistoni assiali, cilindrata variab., 10-2000 rpm, 400 BAR.
Axial pistons motor, variable disp., 10-2000 rpm, 400 BAR.



- Motori a pistoni assiali cilind. fissa 1-1000 rpm 210 BAR.
Axial pistons motor fix. disp. 1-1000 rpm 210 BAR.



- Motori orbitali in 1500 modelli differenti.
Orbital motors in 1500 different type.



- Motori a pistoni assiali cilind. variabile 1-1000 rpm 210 BAR.
Axial pistons motor variable disp. 1-1000 rpm 210 BAR.



- Motori a pistoni assiali, cilindrata fissa, 10-500 rpm, 180 BAR.
Axial pistons motor, fixed displacement, 10-500 rpm, 180 BAR.



- Esploso motori SF.
SF motor exploded view.



- Motori a pistoni assiali, cilindrata fissa, 10-300 rpm, 180 BAR.
Axial pistons motor, fixed displacement, 10-300 rpm, 180 BAR.





PRODOTTI | PRODUCTS

- Casappa: Master Distributor.
- Walvoil: Master distributore.
- Bosch Rexroth: oleodinamica industriale/mobile.
- Sauer Danfoss: motori orbitali, PVG, trasmissioni.
- Reggiana Riduttori: riduttori, ruote, freni.
- Hydac: accumulatori, filtri, scambiatori.
- Ikron: gamma completa filtri.
- Faster: innesti rapidi, Multifaster.
- OG Systemflex - Bridgestone: tubi flessibili e raccordi.
- OG Impianti: centrali oleodinamiche.
- OG Cilindri: cilindri ISO - DIN.

- *Casappa: Master Distributor.*
- *Walvoil: Master distributor.*
- *Bosch Rexroth: Industrial /mobile hydraulics.*
- *Danfoss: orbital motors, PVG, hydrostatic transmissions.*
- *Reggiana Riduttori: Planetary gears, wheels, brakes.*
- *Hydac: accumulators, filters, heat exchangers.*
- *Ikron: full range.*
- *Faster: quick release couplings, Multifaster.*
- *OG Systemflex - Bridgestone: hoses and fittings production.*
- *OG Technologies: hydraulic systems, powerpacks.*
- *OG Cilindri: cylinders ISO-DIN.*



OLEODINAMICA GIANNINI SRLU
 Via Arno 13 - 50019 Osmannoro (FI)
 Tel. +39 055 374691/2/3
www.oleodinamicagiannini.it
sales@oleodinamicagiannini.it

DIRETTORE GENERALE | GENERAL MANAGER:
 Margherita Giannini

H

P

M



FATTURATO | TURNOVER:
 Euro 4.010.000,00



DIPENDENTI | EMPLOYEES:
 14

- WALVOIL: centro assemblaggio.
WALVOIL: master distributor.



- CASAPPA: assemblaggio pompe e motori in ghisa.
CASAPPA: master distributor.



- SAUER DANFOSS: motori e idroguida.
SAUER DANFOSS: motors and steering units.



- WALVOIL: assemblaggio distributori.
WALVOIL: electrohydraulic valves assembly.



- CASAPPA: assemblaggio pompe e motori in alluminio.
CASAPPA: pumps and motors.



- SAUER DANFOSS: assemblaggio proporzionali PVG.
SAUER DANFOSS: PVG assembly.



- BOSCH REXROTH: sistemi oleodinamici.
BOSCH REXROTH: hydraulic systems.



- BOSCH REXROTH: montaggio su centrali.
BOSCH REXROTH: assembly on systems.



- SYSTEMFLEX: tubi e raccordi.
SYSTEMFLEX: hose and fittings.





H

P

M

**OLEOTEC SRL**

Via Varese 19 - 21050 Cantello (VA)
 Tel +39 0332 419711 - Fax +39 0332 417565
 www.oleotec.it
 info@oleotec.it

AMMINISTRATORE | MANAGING DIRECTOR:

Roberto Luoni

**FATTURATO | TURNOVER:**

Euro 4.800.000,00

**DIPENDENTI | EMPLOYEES:**

17

**ALTRE INFORMAZIONI | OTHER INFORMATION**

Distributori | Distributors:

TRANSFER OIL:

tubi e raccordi / hoses and fittings

PTC SYSTEM:

sistemi per la pulizia tubi / hose cleaning systems.

PRODOTTI | PRODUCTS

Oleotec S.r.l. è operativa dal 1976 nel settore dell'oleodinamica. Siamo specializzati nella produzione di miniprese di pressione, micro-tubi, raccordi e accessori per il controllo della pressione, che vendiamo in tutto il mondo con il marchio MCS®.

Tubi flessibili termoplastici completano la gamma. Oleotec opera in accordo alle norme ISO 9001, per garantire prodotti di alta qualità ed affidabilità.

Oleotec S.r.l. has been operating in the fluid power industry since 1976. We are specialized in manufacturing test points, micro-hoses, micro-fittings and accessories for pressure control, which we sell all over the world under the brand name MCS®.

Flexible hoses and thermoplastic hoses are also part of our product range. We comply with ISO 9001 standards, which guarantee high-quality and reliability.



➤ **TUBI PER ALTE PRESSIONI | HIGH-PRESSURE HOSES.**

Tubi e raccordi per alte ed altissime pressioni.
Hoses and fittings for high and very high pressures.

➤ **STRUMENTI DI CONTROLLO PRESSIONE | PRESSURE TECHNOLOGY.**

Miniprese di pressione, tubi, raccordi, manometri.
Test points, hoses, fittings, gauges.



➤ **SISTEMI PULIZIA TUBI | HOSE CLEANING SYSTEMS.**



ptc system®
FOR AIR AND OIL



OFFICINE
MECCANICHE
PIEMONTESI



OMP OFFICINE MECCANICHE PIEMONTESI SRL

Via Rolando Perino 62/B - 10080 Busano (TO)

Tel +39 0124 477111 - Fax +39 0124 477100

www.omp-group.com

info@omp-group.com

AMMINISTRATORI | MANAGING DIRECTOR:

Domenico Rosboch



FATTURATO | TURNOVER:

Euro 70.000.000,00



DIPENDENTI | EMPLOYEES:

240



ALTRE INFORMAZIONI | OTHER INFORMATION

Elenco aziende in Italia:

OMP s.r.l. - Busano (TO)

O.S.VA s.r.l. - Valperga (TO)

Elenco aziende all'estero:

OMP INDIA - Haryana (INDIA)

PRODOTTI | PRODUCTS

- Flange, Spindle, Alberi, Manicotti Scorrevoli, Crociere, Ingranaggi, Supporti Porta Satelliti, Scatole Differenziali, Mozzi, Supporti Porta Corone, Mix.

- Flanges, Spindles, Shafts, Covers, Spiders, Gears, Planet Carriers, Cover & Clutch Collar, Differential Cases, Hub, Miscellaneous.

H

P

M

PRODOTTI | PRODUCTS

OMP, dal 1956, componentistica di meccanica di precisione per le Drive-Lines dell'Automotive On-Highway e Off-Highway.

L'azienda è in grado di produrre annualmente 3.000.000 di componenti stampati e lavorati integralmente all'interno dei propri stabilimenti.

Flange, spindle, alberi, manicotti scorrevoli, crociere, ingranaggi, supporti porta satelliti, scatole differenziali, mozzi, supporti porta corone, mix.

OMP, since 1956, mechanical manufacturing products for on-Highway and Off-Highway Drive-Lines automotive.

OMP is equipped to produce 3.000.000 components of forged and finished parts fully produced in our plants.

Flanges, spindles, shafts, covers, spiders, gears, planet carriers, cover and clutch collar, differential cases, hub, miscellaneous.



➤ *Ecceellenza tecnologica e qualità dei servizi offerti.
Technology, quality and service excellence.*

➤ *Produzione di parti meccaniche per veicoli commerciali e macchine movimento terra.
Mechanical manufacturing for the Automotive and Earth moving sector.*

➤ *Flessibilità nella pianificazione, alti standard di sicurezza per i lavoratori.
Plan flexibility and high safety standard for our workers.*





OMSI
TRASMISSIONI

H

P

M



OMSI TRASMISSIONI SPA

Via S. Pietro, 60 - 25077 Roè Volciano (BS)

Tel +39 0365 563400

www.omsitrasmissioni.com

info@omsitrasmissioni.com

PRESIDENTE | PRESIDENT:

Soncina Renato



FATTURATO | TURNOVER:

Euro 90.000.000,00



DIPENDENTI | EMPLOYEES:

220



ALTRE INFORMAZIONI | OTHER INFORMATION

Unità produttiva | Production unit:

Production: Via Missana, 31 - 25077 Roè Volciano (BS)

Assembly: Via Industriale, 52 - 25080 Prevalle (BS)

Società del gruppo | Daughter companies:

- OMSI Transmissions, Inc. - USA
www.omsitrasmissions.com
- OMSI Trade (Shanghai) Co., Ltd - China
www.omsi.com.cn
- OMSI Trasmissioni SpA - Francia
galmicheo@omsitrasmissioni.com
- OMSI Software & Control Srl - Italia
www.omsi-software.com
- COBRA Srl - Italia
www.cobrariduttori.com
- EMMEQUATTRO Srl - Italia
www.emmequattroaxles.it

PRODOTTI | PRODUCTS

OMSI offre una gamma completa di soluzioni per camion, macchine agricole, movimento terra, veicoli ferroviari, riduttori speciali anche per mescolatori di calcestruzzo. OMSI progetta, sviluppa e produce internamente prese di forza (PTO), gruppi di trasmissione idrostatica, assali (PTO), gruppi di trasmissione idrostatica, assali, cambi di velocità, riduttori ferroviari, completandoli con componenti idraulici ed elettrici selezionati e con il proprio software di controllo avanzato.

OMSI offers a unique range of products for trucks, agricultural, earthmoving machines, rail vehicles, customized gearboxes for precast mixing plants too. OMSI designs, develops and manufactures internally power take-offs (PTOs), hydrostatic transmission units, axles, transmissions, special gearboxes and railway reduction units, equipping them with hydraulics or electrical components and its own advanced control software.



➤ **Trasmissioni idrostatiche.**
Hydro-mechanical drives.

➤ **Assali e cambi, trasmissioni ferroviarie.**
Axles and gearboxes, railway reduction units.



➤ **Prese di forza.**
Power take-offs.





OMT GROUP SPA

Via Lombardia 14 - 24040 Calvenzano (BG)
Tel +39 0363 860311 - Fax +39 0363 335620
www.omtgroup.it
omtgroup@omtgroup.it

DIRETTORE GENERALE | GENERAL MANAGER:
Fiorenzo Chiari



FATTURATO | TURNOVER:
Euro 30.000.000,00



DIPENDENTI | EMPLOYEES:
102



ALTRE INFORMAZIONI | OTHER INFORMATION

Vicini al cliente in tutto il mondo.

La rete commerciale, preparata ed efficiente, offre un servizio ed una consulenza in tutto il mondo.

Close to the customers around the world.

A trained sales network provides service and advise to customers all over the world.

PRODOTTI | PRODUCTS

La produzione si articola in sei macro-gruppi:

- Lanterne e giunti, componenti per mini-centrali, accessori;
- Filtri sulle linee di aspirazione e di ritorno e filtri in pressione;
- Scambiatori di calore aria/olio e acqua/olio;
- Flange SAE, raccordi in acciaio ed alluminio, blocchi CETOP;
- Accumulatori a sacca, a membrana e a pistone;
- Valvole e componenti integrati.

Actually, there are six macro-groups of products:

- *Bellhousings and drive couplings, components for micro-powerpacks, accessories;*
- *Filters, suitable for both suction and return lines and pressure filters;*
- *Air/oil and water/oil heat exchangers;*
- *SAE flanges - aluminum and steel couplings, CETOP manifold;*
- *Bladder, diaphragm and piston accumulators;*
- *Valves and integrated components.*



➤ Componenti e accessori.
Components and accessories.



➤ Filtri idraulici.
Hydraulic filters.



➤ Scambiatori di calore.
Heat exchangers.



➤ Flange, raccordi, blocchi.
Flanges, couplings, manifold blocks.



➤ Accumulatori a sacca, a membrana e a pistone.
Bladder, diaphragm and piston accumulators.



➤ Valvole idrauliche e componenti integrati.
Hydraulic valves and integrated components.

**OP SRL**

Via Serpente 97 - 25131 Brescia (BS)
 Tel +39 030 3580401 - Fax +39 030 3580838
 www.op-srl.it
 info@op-srl.it

AMMINISTRATORE | *MANAGING DIRECTOR:*
 Daniele Piantoni



FATTURATO | *TURNOVER:*
 Euro 16.150.000,00



DIPENDENTI | *EMPLOYEES:*
 54

**ALTRE INFORMAZIONI** | *OTHER INFORMATION*

Filiali in Cina (Shanghai), USA (Boston) e India (Nuova Delhi).
 Rete commerciale globale con l'ausilio di agenti e distributori.

*Branches in China (Shanghai), USA (Boston) and India (New Delhi).
 Global sales network with distributors and representatives.*

PRODOTTI | PRODUCTS

Attrezzature per la lavorazione di tubi flessibili oleodinamici: raccordatrici, taglierine, spellatubi, macchinari per il premontaggio di raccordi, banchi di collaudo.

Mobile Hose Workshop: officina mobile attrezzata per la lavorazione di tubazioni flessibili.

Attrezzature per la lavorazione di tubi rigidi oleodinamici: curvatubi, macchinari per premontaggio di anelli DIN e svasatura a 37°- 90°, sbavatori e unità mobili multifunzione.

Flexible hose processing equipment: crimping, cutting, skiving, fittings preassembling machines, test benches. Mobile Hose Workshop: fully equipped mobile container for the flexible hose assembly.

Rigid tube processing equipment: bending, DIN rings preassembling, 37°- 90° flaring and deburring machines, mobile multifunctional units.

Stopflex⁺

op Pressure Hose Safety



➤ **Stopflex** - Sistema brevettato di trattenimento per tubi flessibili in pressione.
Stoplex - Patented retention system for flexible hoses under pressure.

➤ L'ampia gamma di attrezzature offerte da OP permette di soddisfare qualsiasi esigenza di lavorazione di tubazioni flessibili e rigide.
The wide range of equipment offered by OP allows to satisfy any hose and tube assembly needs.



➤ **Banchi di collaudo Hydro+Power**, per componenti fluidodinamici, meccanici e per la filtrazione di liquidi.
Hydro+Power test benches, for mechanical, hydraulics and liquid filtration components.





PARKER HANNIFIN ITALY SRL

Via Caboto 1 - 20094 Corsico (MI)
Tel +39 02 451921 - Fax +39 02 4479340
www.parker.com/it
parker.italy@parker.com

DIRETTORE GENERALE | GENERAL MANAGER:
Barry Mackay



FATTURATO | TURNOVER:
Euro 318.086.637,00



DIPENDENTI | EMPLOYEES:
166



ALTRE INFORMAZIONI | OTHER INFORMATION

Unità produttiva | Productive unit:
European Product Information Center
Tel 00800 2727 5374
epic@parker.com

Società all'estero | Foreign associated companies:
In 50 Paesi.
In 50 Countries.

Filiali, uffici tecnici e stabilimenti in Italia | Branches, technical offices and manufacturing sites in Italy:
Gessate (MI), Cinisello Balsamo (MI),
Arsago Seprio (VA), Cellatica (BS), Adro (BS),
Anzola dell'Emilia (BO), S. Angelo di Piove (PD),
Leini (TO), Veniano (CO)

PRODOTTI | PRODUCTS

Cilindri pneumatici, Attuatori vari, Accessori per cilindri pneumatici, Valvole ed elettrovalvole, Valvole ausiliarie, Accessori per valvole ed elettrovalvole, Motori pneumatici, Deceleratori, Tubi flessibili, Tubi rigidi, Tubi industriali, Tubi per gas e olio, Raccordi, Innessi rapidi, Filtri, Riduttori di pressione, Lubrificatori, Guarnizioni, Manometri, Pressostati, Termostati, Trasduttori, Flussometri, Componenti per il vuoto, Azionamenti.

Pneumatic cylinders, Various actuators, Accessories for pneumatic cylinders, Valves and solenoid valve, Auxiliary valves, Accessories for valves and solenoid valves, Air motors, Decelerators, Flexible hoses, Rigid tubes, Industrial hoses, Oil & Gas hoses, Connectors (fittings), Quick couplings, Filters, Pressure regulators, Lubricators, Seals, Pressure gauge, Pressure switches, Thermostats, Transducers, Flowmeters, Vacuum components, Drives.

**GVM**

Motore GVM (Motore Globale per Veicoli).
Global Vehicle Motor (GVM).

Drive Controlled Pump

Sistema oleodinamico a velocità variabile con elevata efficienza energetica.
Variable-speed hydraulic pump system providing high energy efficiency.



Il controllo assi di Parker (PAC) è basato su Ethercat ed aiuta i costruttori di macchine a realizzare sistemi di controllo ad alte prestazioni.
The EtherCAT based Parker Automation Controller (PAC) helps OEMs produce high-performance control systems.





ALTRE INFORMAZIONI | OTHER INFORMATION

PNEUMAX Group è uno dei principali player internazionali nel settore dei componenti e sistemi per l'automazione industriale, automazione di processo e automotive, capofila del Gruppo omonimo costituito da 27 società che occupano 800 collaboratori nel mondo.

PNEUMAX Group is one of the leading international manufacturers of components and systems for industrial automation, process automation and automotive. The Pneumax Group consist of 27 companies with over 800 employees worldwide.

PRODOTTI | PRODUCTS

Attuatori pneumatici, manipolazione, valvole ed elettrovalvole, tecnologia proporzionale, trattamento aria, raccordi, tecnologia del vuoto, valvole di processo, valvole ed elettrovalvole per fluidi, cilindri ed assi elettrici, motori e drives. Componenti per applicazioni in lastratura: unità di bloccaggio, unità di centraggio, pinze, unità rotanti e posizionatori multiasse completi per allineamenti geometrici.

Pneumatic actuators, manipulation, valves and solenoid valves, proportional technology, air treatment, fittings, vacuum technology, process valves, valves and solenoid valves for fluids, electric cylinders and axes, motors and drives. Components for body in white applications: clamping units, locating units, grippers, power pivots and complete multi-axis positioning systems.



PNEUMAX



PNEUMAX GROUP

Via Cascina Barbellina 10 - 24050 Lurano (BG)
Tel +39 035 4192777 - Fax +39 035 4192740/1
www.pneumaxspa.com
info@pneumaxspa.com

Amministratore DELEGATO | CEO:

Rossella Bottacini



FATTURATO | TURNOVER:

Euro 130.000.000,00



DIPENDENTI | EMPLOYEES:

800

➤ Componenti e sistemi per l'Automazione Industriale.
Components and systems for Industrial Automation.



➤ Tecnologia per l'Automazione di Processo.
Process Automation Technology.



➤ Componenti per applicazioni in lastratura nell'Automotive.
Components for Automotive Body in White (BiW) applications.

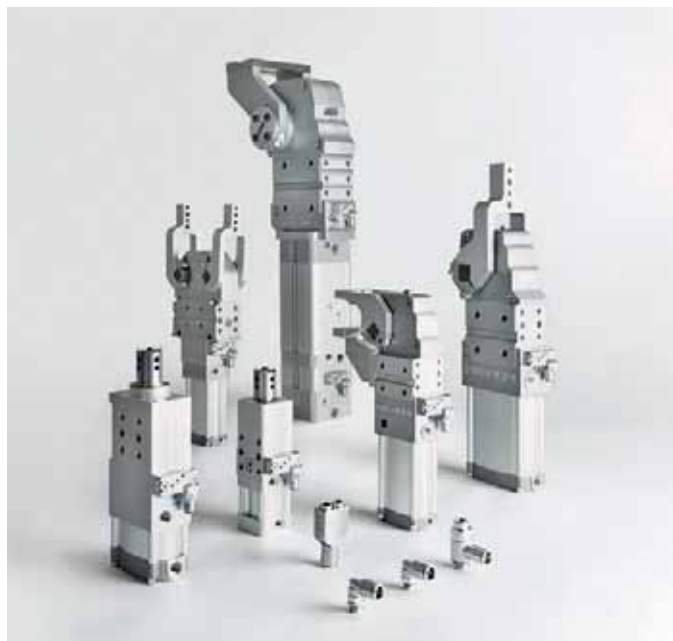

PRODOTTI | PRODUCTS

Investimenti continui in ricerca e sviluppo hanno permesso a Pneumax di ampliare l'offerta di prodotti e soluzioni affiancando alla consolidata tecnologia pneumatica, l'attuazione elettrica ed i componenti per il controllo dei fluidi liquidi e gassosi, mantenendo una flessibilità organizzativa che consente di risultare altamente competitiva sia nella fornitura di prodotti standard che di soluzioni completamente personalizzate, pannelli e sistemi integrati.

Continuous investments in research and development allowed Pneumax to expand the range of products and solutions, adding further to pneumatic technology, electric actuation and the production of components for fluid control, both liquid and gaseous, maintaining an organizational flexibility that allows the company to be highly competitive in the supply of standard components as well as completely customized solutions and integrated systems.



➤ Modulo multi-seriale Serie PX.
Multi-serial module PX Series.

➤ Elettrovalvole EVO.
EVO Solenoid valves.

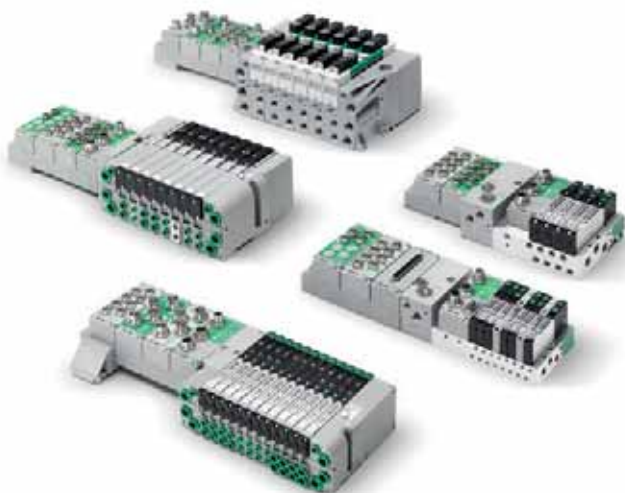

➤ Regolatori proporzionali Serie 1700 - Industrial Fieldbus.
Proportional regulator 1700 Series - Industrial Fieldbus.





➤ Fluid Control.
Fluid Control.



➤ Tecnologia del Vuoto.
Vacuum Technology.



➤ Raccordi in ottone, tecnopolimero o acciaio.
Brass, technopolymer and stainless steel fittings.



➤ Attuatori pneumatici e manipolazione.
Pneumatic actuators and handlings.



➤ Attuazione elettrica.
Electric Actuation.



➤ Trattamento aria.
Air Treatment.



PRODOTTI | PRODUCTS

Dal 1968 Promatec è il punto di riferimento per le aziende partner nel settore fluidodinamico e meccanico. Commercializziamo e distribuiamo prodotti di altissima qualità certificati come tubi, raccordi, innesti rapidi, motori e pompe a pistoncini, valvole, flange, giunti, degasatori, filtri, macchine per la deformazione del tubo rigido e componentistica. Progettiamo e realizziamo inoltre soluzioni con prodotti stand alone, kit o assemblati.

Since 1968 Promatec has been the point of reference for partner companies in the fluid dynamics and mechanical sectors. We market and distribute certified high quality products such as pipes, fittings, quick couplings, motors and piston pumps, valves, flanges, joints, degassers, filters, machines for forming rigid pipes and components. We also design and create solutions with stand-alone, kit or assembled products.



PROMATEC SPA
Via Per Castelletto 3/5 - 20080 Albairate (MI)
Tel +39 02 9469801
www.promatec.it
info@promatec.it

AMMINISTRATORE DELEGATO | CEO:
Filippo Marelli



FATTURATO | TURNOVER:
Euro 24.861.000,00



DIPENDENTI | EMPLOYEES:
40



- Innesti rapidi in materiale plastico (CPC).
Plastic quick couplings (CPC).



- Innesti rapidi, a sfera, a vite, faccia piana, check valves.
Quick couplings, check valves.



- Motori e pompe a pistoni radiali di Poclairn Hydraulics.
High torque radial piston motors and pumps of Poclairn Hydraulics.



- Componenti bassa pressione: filtri, tubi, raccordi, degasatori.
Filters, pipes, fittings, degassers.



- Valvole a sfera; Giunti rotanti; Flange; Staffe.
Ball valves; Rotary joint; Flanges; Clamps.



- Tubi preformati su disegno per tutti i fluidi.
Preformed hoses for all types of fluids.



- Tubi flessibili Gates. Assemblaggio e prove al banco statico ed impulsivi.
Gates Flexible hoses. Assembly and tests on the bench static and impulse.



- Raccorderia DIN 2353 anche con elastomero.
DIN 2353 cutting ring fittings, with elastomer too.



- Macchina deformazione tubo rigido Walform.
Walform Machine.





RONZIO OLEODINAMICA SPA

Viale Industria 37/39
20010 Boffalora Sopra Ticino (MI)
Tel +39 02 9754057 - Fax +39 02 97255070
www.ronzio.com - sales@ronzio.com

Amministratore | *MANAGING DIRECTOR:*

Franca Ronzio



DIPENDENTI | *EMPLOYEES:*

45



ALTRE INFORMAZIONI | *OTHER INFORMATION*

Lavoriamo con partner e clienti nazionali e internazionali. Collaboriamo con rivenditori qualificati in tutto il mondo: Germania, Svezia, Spagna, UK, Irlanda, Turchia, Russia, Cina, Australia, Nuova Zelanda. Inoltre abbiamo una nostra sede in Minnesota - USA, con cui riforniamo il mercato americano.

Our company works for national and international customers. We work with qualified dealers all over the world: Germany, Sweden, Spain, UK, Ireland, Turkey, Russia, China, Australia, New Zealand. We also have a company in Minnesota - USA, with which we supply the American market.

PRODOTTI | *PRODUCTS*

Pompe e motori in alluminio (serie Z), pompe e motori in ghisa (serie W), divisori di flusso in alluminio e in ghisa, pompe e motori ad alta pressione (serie AP), pompe elicoidali (serie EVO), Fan Drive, pompe e motori per il settore agricolo, pompe e motori per il settore industriale, prodotti customizzati su specifiche esigenze del cliente.

Aluminum pumps and motors (Z series), cast iron pumps and motors (W series), aluminum and cast iron flow dividers, high pressure pumps and motors (AP series), pumps with helical gears (EVO series), Fan Drive, pumps and motors for agricultural applications, pumps and motors for industrial applications, customized products dedicated to different applications.

- Pompe e motori in alluminio (Serie Z).
Aluminum pumps and motors (Z series).



- Pompe e motori in ghisa (Serie W).
Cast iron pumps and motors (W series).



- Divisori di flusso in alluminio e ghisa.
Aluminum and cast iron flow dividers.



- Pompe e motori ad alta pressione (Serie AP).
High pressure pumps and motors (AP series).



- Pompe elicoidali.
Pumps with helical gears (EVO series).



- Fan Drive.



- Pompe e motori per il settore agricolo.
Pumps and motors for agricultural applications.



- Pompe e motori per il settore industriale.
Pumps and motors for industrial applications.



- Prodotti customizzati su esigenze del cliente.
Customized products for various applications.



**SAIP SRL**

Via Lambro 23 - 20073 Opera (MI)
Tel + 39 02 57603913 - Fax +39 02 57604752
www.saip.it
saip@saip.it

CEO | CEO:

Renzini Roberto

**FATTURATO | TURNOVER:**

Euro12.000.000,00

**DIPENDENTI | EMPLOYEES:**

50

**ALTRE INFORMAZIONI | OTHER INFORMATION**

SAIP Srl è un marchio che da oltre 40 anni si distingue nel mondo degli accumulatori idropneumatici e smorzatori di pulsazione per la sua eccellenza qualitativa e rappresenta il perfetto connubio fra innovazione e tradizione.

SAIP Srl is a brand that has stood out for its qualitative excellence in the hydro-pneumatic accumulator and pulsation dampeners sector for over 40 years and represents the perfect combination of innovation and tradition.

PRODOTTI | PRODUCTS

- Accumulatori a sacca
- Accumulatori a membrana
- Accumulatori a membrana saldati
- Accumulatori a pistone
- Accumulatori plastici
- Accumulatori a progetto
- Smorzatori idraulici
- Smorzatori di pulsazione
- Accessori (blocchi di sicurezza, kit precarica).

- *Bladder accumulators*
- *Diaphragm accumulators*
- *Welded diaphragm accumulators*
- *Piston accumulators*
- *Plastic accumulators*
- *Accumulators on project request*
- *Hydraulic dampeners*
- *Pulsation dampeners*
- *Accessories (safety blocks, pre-charging kit).*

- Accumulatori a sacca.
Bladder accumulators.



- Accumulatori a membrana.
Diaphragm accumulators.



- Accumulatori a membrana saldati.
Welded diaphragm accumulators.



- Accumulatori a pistone.
Piston accumulators.



- Accumulatori plastici.
Plastic accumulators.



- Accumulatori a progetto.
Accumulators on project request.



- Smorzatori idraulici.
Hydraulic dampeners.



- Smorzatori di pulsazione.
Pulsation dampeners.



- Accessori per accumulatori.
Accessories.



ALTRE INFORMAZIONI | OTHER INFORMATION
SALAMI Spa

Head Office and Production Plant:
Via Emilia Ovest 1006 - 41123 Modena, Italy
Tel + 39 059 387411 - Fax +39 059 387639
www.salami.it

SALAMI HYDRAULICS NA INC.

Sales Office: 200 Overhill Drive Suite B,
Mooresville NC 28117
Tel 001 704 285 8050

4630 Crossroads Park Drive
Liverpool NY, 13088
Tel 001 315 295 2363 - Fax 001 315 295 2364
www.salamihydraulics.com

SALAMI FRANCE SARL

22, rue Louis Saillant
69120 Vaulx en Velin - Lyon
Tel 0033 4 78809941 - Fax 0033 4 78803669
www.salami.fr

SALAMI OLEODINÁMICA ESPAÑA, S.A.

Polígono Industrial Armenteres - C/ Primer de Maig, 18, Nave 4 - 08980 Sant Feliu de Llobregat (Barcelona)
Tel 0034 93 6665451 - Fax 0034 93 6667826
www.salamiespana.es

SALAMI SPA Società con unico socio

Via Emilia Ovest 1006 - 41123 Modena (MO)
Tel +39 059 387411 - Fax +39 059 387639
www.salami.it
sales@salami.it

PRESIDENTE | PRESIDENT:

Maria Silvia Salami

AMMINISTRATORE | MANAGING DIRECTOR:

Angelo Pucci

DIRETTORE COMMERCIALE | SALES MANAGER:

Eng. Marco Bavutti
marco.bavutti@salami.it
Tel +39 059 387507 - Cell +39 329 4647682

H

P

M

PRODOTTI | PRODUCTS

In Salami progettiamo e produciamo sistemi idraulici integrati con soluzioni elettroniche in grado di rendere sempre più performante l'utilizzo delle macchine operatrici, raggiungendo elevati livelli prestazionali standard. I settori caratteristici delle nostre applicazioni spaziano dall'agricoltura al movimento terra, lavori stradali, edilizia, movimentazione esterna e interna, raccolta rifiuti, marina, miniere, perforazioni minerarie.

At Salami we project and produce hydraulic integrated systems with electronic solutions so to constantly increase our features in using operative machines, reaching high standards of performance levels.

Typical areas of our applications range from agriculture, bulldozers, street works, construction, internal and external handling, garbage collectors, navy, mines and minery drills.



➤ **VD6A**
Valvola direzionale componibile a comando elettro-idraulico proporzionale.
Electro - hydraulic proportional control valve - Sectional type.

➤ **VD8A**
Valvola controllo direzionale - Versione componibile.
Directional control valve - Sectional type



➤ **2PSE** Pompe silenziosa ad ingranaggi con corpo in alluminio.
Low noise gear pump - Aluminium gear housing.
PG330 Pompe ad ingranaggi corpo in ghisa. | *Cast iron gear pumps.*





SCHAEFFLER



SCHAEFFLER ITALIA SRL

Via Dr. Georg Schaeffler 7
28015 Momo (NO)
Tel +39 0321 929211
www.schaeffler.it - info.it@schaeffler.com

Deputy Country Manager Italy:

Ing. Mauro Rizzolo



DIPENDENTI | EMPLOYEES:

130

Sito | Site Momo:
ISO 14001:2015 - ISO 45001:2018
ISO 50001:2011 - EMAS

Stabilimento produttivo | Production plant:
ISO 9001:2008 - IATF 16949



ALTRE INFORMAZIONI | OTHER INFORMATION

Schaeffler Italia è la filiale italiana del Gruppo Schaeffler e commercializza sul mercato italiano i prodotti a marchio INA, FAG e LuK per applicazioni industriali ed automotive. Nella sede dell'azienda a Momo è presente anche uno stabilimento di produzione (componenti automotive).

Schaeffler Italia is the Italian seat of the Schaeffler Group and markets INA, FAG and LuK brand products for industrial and automotive applications in Italy. The company's headquarter in Momo also hosts a production plant (automotive components).

PRODOTTI | PRODUCTS

La Divisione Industrial offre un'ampia gamma di soluzioni di cuscinetti, da quelli ad alta velocità ed alta precisione con diametro piccolo a quelli di grandi dimensioni con diametro di diversi metri. Il focus è sempre di più su prodotti e servizi smart e sui componenti connessi.

The Industrial Division offers a wide range of bearing solutions, from high speed and high precision bearings with small diameter to large bearings with a diameter of several meters. The focus is increasingly on smart products and services and on interconnected components.



➤ Sistema di condition monitoring Schaeffler OPTIME.
Condition monitoring solution Schaeffler OPTIME.

➤ Cuscinetti massicci a rullini.
Machined needle roller bearings.



➤ Cuscinetti radiali orientabili a rulli.
Radial spherical roller bearings.





➤ Cuscinetti radiali rigidi a sfere.
Deep groove ball bearings.



➤ Cuscinetti assiali orientabili a rulli.
Axial spherical roller bearings.



➤ Cuscinetti a rulli cilindrici.
Cylindrical roller bearings.



➤ Cuscinetti a rulli conici.
Tapered roller bearings.



➤ Guide lineari.
Linear guidance systems.



➤ Sensori di coppia.
Torque sensors.



➤ Attuatori elettromeccanici P.ACT.
P.ACT linear actuators.



➤ Motori torque.
Torque motors.



➤ SmartCheck.



➤ ProLink.
ProLink condition monitoring system.



➤ Lubrificatori CONCEPT.
CONCEPT lubrication systems.



➤ Grassi Arcanol.
Arcanol greases.



 **PRODOTTI** | PRODUCTS

Pneumatica.
Tubi lineari e spirali per aria compressa e fluidi. Tubi speciali per applicazioni industriali e automotive in materiali termoplastici.

Oleodinamica.
Protezioni per tubi oleodinamici: Spirali in plastica anti-abrasione. Guaine Tessili di contenimento. Guaina tubolare e nastri antifuoco in fibra di vetro e silicone.

Pneumatics.
Linear and recoiled tubing for air and fluids. Custom-made tubing for industrial and automotive applications.

Hydraulics.
Protections for hydraulic hoses: Anti-abrasion plastic spiral wrap. Anti diffusion textile sleeves. Firesleeve and fireproof tape in fiberglass and silicone.

Certificazioni | *Certifications:*
ISO-9001, ISO-9001-14001 e MSHA IC-207



 **SMART PROTECTIONS SRL**
Via Montorfano 66 - 22032 Albese con Cassano (CO)
Tel +39 031 622602
www.smartprotections.com
sales@smartprotections.com

AMMINISTRATORE | *MANAGING DIRECTOR:*
Mikaela Mazzer

 **FATTURATO** | *TURNOVER:*
Euro 5.000.000,00

 **DIPENDENTI** | *EMPLOYEES:*
31

H
P
M

- Tubi pneumatici in diversi materiali: PA, PU, PE ecc.
Pneumatic tubing in various materials: PA, PU, PE etc.



- Tubi per circuiti frenanti in poliammide a norma DIN 74324.
Air brake Polyamid tubing according to DIN 74324.



- Spirali pneumatiche in PA e PU.
Recoiled tubing in PA and PU.



- Textsleeve, guaina tessile in nylon omologata MSHA.
Textsleeve, nylon anti-diffusion sleeve approved by MSHA.



- Texwrap, guaina in nylon con Velcro omologata MSHA.
Texwrap, nylon sleeve with velcro MSHA approved.



- Textstrip, fascette in nylon omologate MSHA.
Textstrip, nylon self docking belts approved by MSHA.



- Shiltek, guaina in fibra di vetro e silicone omologata MSHA.
Shiltek, fiberglass and silicone firesleeve approved by MSHA.



- Shiltape, benda in fibra di vetro e silicone.
Shiltape, fiberglass and silicone tape.



- Kovertec, spirali anti abrasione in diverse forme e materiali.
Kovertec, anti-abrasion wraps in various shapes and materials.



**SMC ITALIA SPA**

Via Delle Donne Lavoratrici, 21
20861 Brugherio (MB)
Tel +39 039 90691 - Fax +39 039 9069361
www.smcitalia.it - mailbox@smcitalia.it

PRESIDENTE | GENERAL MANAGER:

Lucio Moriggi

**FATTURATO | TURNOVER:**

Euro 160.000.000,00

**DIPENDENTI | EMPLOYEES:**

394

**ALTRE INFORMAZIONI | OTHER INFORMATION****Unità produttiva | Productive unit:**

Località Recocce
67061 Carsoli (AQ)
Tel +39 0863 9041 - Fax +39 0863 904316

Società all'estero | Foreign associated companies:

Argentina, Australia, Austria, Belgio, Bolivia, Canada, Cile, Cina, Corea, Danimarca, Filippine, Finlandia, Francia, Germania, Giappone (Casa Madre), Grecia, Gran Bretagna, Hong Kong, India, Irlanda, Israele, Malaysia, Messico, Norvegia, Nuova Zelanda, Olanda, Portogallo, Repubblica Ceca, Romania, Russia, Singapore, Spagna, Svezia, Svizzera, Taiwan, Thailandia, Turchia, Ungheria, U.S.A., Venezuela.

PRODOTTI | PRODUCTS

Componenti pneumatici per automazione industriale e strumentazione pneumatica per industria di processo. Gamma completa di componenti pneumatici: 12.000 prodotti base con 700.000 varianti, suddivisi per famiglie di prodotto. Trattamento aria - Attuatori - Valvole - Componenti per il vuoto - Raccordi e tubi - Dispositivi di controllo. Strumentazione - Scambiatori di calore - Attuatori elettrici - Valvole alto vuoto - Valvole per settore chimico.

Pneumatic components for industrial automation and pneumatic instrumentation for process industries. Complete range of pneumatic components: 12.000 products with 700.000 variations sub-divided per product family. Air Preparation - Actuators - Valves - Vacuum equipment - One touch fitting and tubing - Control Devices - Instrumentation - Heat exchanger - Electric actuators - High vacuum valves - Valves for chemical industry.

H

P

M



➤ **Trattamento Aria.**
Air Line Equipment.



➤ **Essiccatori.**
Air Dryer.



➤ **Thermo-Chiller.**
Thermo-Chiller.



➤ **Elettrovalvole.**
Solenoid Valves.



➤ **Sistemi in Bus di Campo.**
Fieldbus System.



➤ **Valvole di Processo.**
Process Valves.

➤ Valvole per Settore Chimico.
Valves for Chemical Industry.



➤ Cilindri Pneumatici Standard.
Standard Air Cylinders.



➤ Cilindri Pneumatici Standard.
Standard Air Cylinders.



➤ Cilindri Compatti.
Compact Cylinders.



➤ Cilindri Compatti Guidati.
Compact Guided Cylinders.



➤ Cilindri Combinati.
Combination Cylinders.



➤ Cilindri con Funzioni Speciali.
Specialty Cylinders.



➤ Attuatori Rotanti.
Rotary Cylinders.



➤ Pinze Pneumatiche.
Air Grippers.



➤ Attuatori Elettrici.
Electric Actuators.



➤ Componenti per il Vuoto.
Vacuum Equipment.



➤ Valvole Alto Vuoto.
High Vacuum Valves.



➤ Sensori di Pressione
Pressure Sensors.



➤ Sensori di Portata.
Flow Sensors.



➤ Ionizzatori.
Ionizers.



➤ Raccordi.
Fittings.



➤ Regolatori di Flusso.
Speed Controllers.



➤ Tubi Plastici.
Tubing.





ALTRE INFORMAZIONI | OTHER INFORMATION

Sogeac opera dal 1987 nella produzione e vendita di componenti pneumatici per automazione. È in grado di soddisfare sia il costruttore di impianti e macchinari industriali che il distributore di componenti pneumatici per automazione, oltre agli utilizzatori finali.

Sogeac is operating since 1987 in the production and sale of pneumatic components.

Sogeac is able to satisfy the producer of systems/industrial machinery, the distributor of pneumatic for automation and also the final customer.

PRODOTTI | PRODUCTS

Cilindri, accessori di fissaggio conformi alle diverse normative ISO-UNITOP-CETOP-CNOMO. Cilindri corsa breve, serie HB, serie E, cilindri a disegno anche in acciaio inox.

Distributore generale per l'Italia **CONTITECH** molle ad aria, **YPC** elettrovalvole e raccordi, **NASS MAGNET** elettropiloti, bobine, connettori (standard ed ATEX), **RFS** elettrovalvole varie. **EMC** gruppi trattamento aria e componentistica pneumatica per automazione.

Serbatoi in acciaio verniciato, zincati, inox certificati ed a norma.

*Cylinders, mounting accessories in compliance with standard ISO-UNITOP-CETOP-CNOMO Short stroke cylinders, series HB, series E, cylinders on drawing and Stainless Steel. Distributor for **CONTITECH** air spring, **YPC** solenoid valve and fitting, **NASS MAGNET** armature assembly, coils, connectors (also ATEX), **RFS** various solenoid valves. **EMC** air treatment units and pneumatic components for automation. Tanks in painted steel, hot galvanized, stainless steel according to European standard.*

SOGEAC s.r.l. 



SOGEAC SRL

Via Piave snc - 27020 Scaldasole (PV)

Tel +39 0382 997863

www.sogeac.it - info@sogeac.it

RESP. COMMERCIALE | COMM. MANAGER:

Danilo Orsenigo

COMM. ESTERO | EXPORT SALES MANAGER:

Elena Lucini



FATTURATO | TURNOVER:

Euro 2.000.000,00



DIPENDENTI | EMPLOYEES:

6

H
P
M

› Cylinders in compliance to ISO 15552, ISO 6432, ISO 21287, UNITOP, CNOMO, CETOP.



› Cylinders series: HB, ED, EUROPA, cartridge, compact and special features, also Stainless Steel.



› Accessories for cylinders, magnetic sensors, anti-rotation guide, rod lock, rod forks and joints.



› CONTINENTAL-CONTITECH Air spring bellows and rolling lobes from Germany.



› Solenoid valves, pneumatic valves and pneumatic components YPC from South Korea.



› Push-in fittings, polyurethane tubes and extraflex spirals YPC from South Korea.



› Armature assembly, connectors, coils and pilot valves NASS MAGNET (standard and ATEX).



› EMC: air treatment units, pneumatic components.



› Painted and galvanized steel tanks, stainless steel tanks and safety valves with certificate CE/PED.





STAUFF ITALIA SRL

Via Como 9 - I 23846 Garbagnate Monastero (LC)
 Tel +39 031 658494 - Fax +39 031 655005
www.stauff.com
sales@stauff.it

DIRETTORE GENERALE | GENERAL MANAGER:
 Domenico Modesto



FATTURATO | TURNOVER:
 Euro 24.000.000,00



DIPENDENTI | EMPLOYEES:
 55



ALTRE INFORMAZIONI | OTHER INFORMATION

Stauff Italia è una società del gruppo Walter Stauffenberg GmbH KG con sede a Werdhol in Germania. La produzione, vendita e servizio sono presenti in Europa, America, Asia, inoltre in 18 nazioni una rete di distributori autorizzati assicura un servizio a livello mondiale di elevata qualità.

Stauff Italy is branch of Walter Stauffenberg GmbH KG, headquartered in Werdhol, Germany. The production, sales and service are present in Europe, America, Asia, more, in 18 countries a network of authorized distributors ensures a world-class service of high quality.

PRODOTTI | PRODUCTS

Da oltre 50 anni STAUFF sviluppa, produce e distribuisce componenti per tubazioni, componenti oleodinamici per impianti industriali e mobili e per la manutenzione. In catalogo oltre 40.000 prodotti standard, così come numerose soluzioni sviluppate su specifiche dei clienti. Tutti i prodotti sono conformi alle regole internazionali e conformi al sistema di qualità ISO oltre che diverse altre certificazioni. Inoltre, la protezione superficiale zinco-nichel caratterizza i prodotti Stauff-Line.

From more than 50 years STAUFF develop, manufacture, distribute components for piping, hydraulic components for industrial and mobile systems and maintenance. In catalogue there are 40,000 standard products, as well as numerous solutions developed on customer specifications. All products are conformed with international rules and ISO quality system as well as various other certifications. The zinc-nickel surface protection characterizes Stauff-Line products.

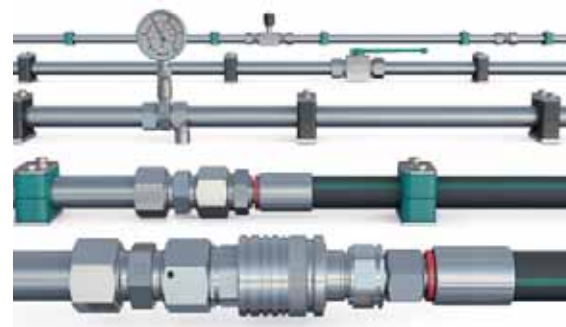

➤ Stauff Line significa componenti compatibili prodotti da unico fornitore.
Stauff Line means perfectly matching components from one supplier.

➤ Stauff Italia produce tubazioni a disegno e tubazioni flessibili.
Stauff Italy is tube processing and flexible hoses assembler.



➤ Stauff produce una gamma completa di componenti per oleodinamica.
Stauff produces a complete range of components for hydraulics.





ALTRE INFORMAZIONI | OTHER INFORMATION

Società all'estero | Foreign associated companies:

Stucchi USA Inc

Stucchi (Shanghai), China

Stucchi FCP Pty Ltd., Australia

Stucchi Engates, Brazil

Stucchi South Africa (Pty) Ltd.

PRODOTTI | PRODUCTS

Fondata nel 1960, Stucchi è oggi uno dei principali produttori mondiali di soluzioni per la connessione e gestione dei fluidi.

Gli innesti rapidi Stucchi sono progettati e prodotti in Italia per coprire una vasta gamma di applicazioni in numerosi settori; possono operare fino a 700 bar e sono disponibili in diversi materiali, misure e configurazioni.

Founded in 1960, Stucchi is today one of the main producers of solutions for fluids connection and control.

Stucchi quick couplings, operating up to pressures of 700 bar, are designed and produced in Italy to cover a wide range of applications, thanks to the use of different materials, and the numerous sizes and configurations available.

STUCCHI SPA
Via della Lira Italiana 397- 24040 Pagazzano (BG)
Tel +39 0363 380100 - Fax +39 0363 380171
www.stucchigroup.com
info@stucchigroup.com

AMMINISTRATORE DELEGATO | CEO:
Lorenzo Zaffaroni

€ FATTURATO | TURNOVER:
Euro 83.200.000,00

👥 DIPENDENTI | EMPLOYEES:
240

- Innesti rapidi Faccia Piana (ISO 16028).
Flat face quick couplings (ISO 16028).



- Innesti rapidi Faccia Piana a Vite.
Flat Face Screw quick couplings.



- Multinnesti per connessioni multiple.
Multicouplings for multiple connections.



- Monoblocco SATURN per skid-steer.
SATURN casting for skid-steer.



- Innesti rapidi a Funghetto (ISO 7241-A, B e altri).
Poppet quick couplings (ISO 7241-A, B and others).



- Innesti rapidi a Funghetto con Vite.
Poppet Screw quick couplings.



- Innesti per alta pressione (fino a 700 bar).
High pressure quick couplings (up to 700 bar).



- Innesti per ricarica dell' A/C dei veicoli.
Couplings for vehicle A/C recharge.



- Valvole unidirezionali.
Check valves.





ALTRE INFORMAZIONI | OTHER INFORMATION

TAU Service S.r.l. è un'azienda con sede a Cardano al Campo, in provincia di Varese, specializzata in movimentazione lineare (concessionari ufficiale Hiwin), componenti pneumatici (concessionari ufficiali Camozzi), tecnologia del vuoto (concessionari ufficiali Piab) e altri prodotti industriali. La nostra competenza e dinamicità ci permettono di trovare soluzioni tempestive ed efficaci ai problemi dei nostri clienti, anche quelli più complessi ed insoliti. Siamo pronti a supportarvi con il nostro servizio di qualità nel settore delle forniture industriali.

TAU Service S.r.l. is a company based in Cardano al Campo, in the province of Varese, specializing in linear motion, pneumatic components, vacuum technology, and other industrial products. Our expertise and agility enable us to find timely and effective solutions to our clients' challenges, even the most complex and unusual ones. We are ready to support you with our quality service in the field of industrial supplies.



TAU SERVICE SRL

Via A. Volta 64 - 21020 Cardano Al Campo (VA)

Tel + 39 0331 776861

www.tausrl.it

info@tausrl.it

CEO | CEO:

Andrea Matarese



FATTURATO | TURNOVER:

Euro 8.700.000,00



DIPENDENTI | EMPLOYEES:

25

➤ TAU Service S.r.l. Concessionaria Ufficiale Camozzi.



➤ TAU Service S.r.l. Concessionaria Ufficiale Hiwin.

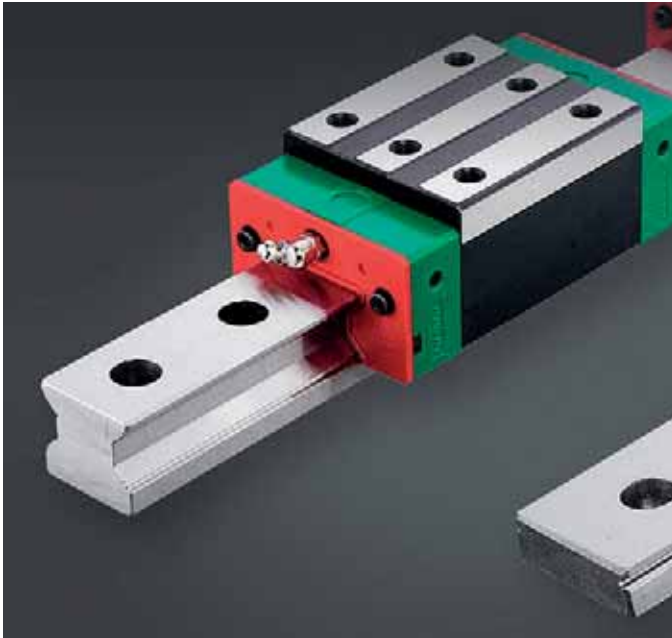

➤ TAU Service S.r.l. Concessionaria Ufficiale Piab.



**TITAN ENGINEERING SPA**

Via Dei Cerri 16 (Loc. Ciarulla)
47899 Serravalle (Repubblica di San Marino)
Tel +39 0549 960419 - Fax +39 0549 960421
www.titanengineering.sm
info@titanengineering.sm

DIRETTORE | *MANAGING DIRECTOR:*
Francesco De Lillo



FATTURATO | *TURNOVER:*
Euro 7.780.000,00



DIPENDENTI | *EMPLOYEES:*
31

**ALTRE INFORMAZIONI** | *OTHER INFORMATION*

La nostra società, in quanto parte del Gruppo Pneumax, si avvale della stessa organizzazione commerciale.

Filiali Italia | *Italian Branches:*

Milano-Brianza, Torino, Vicenza, Toscana, Bari, Modena, Parma, Rimini.

Società all'estero | *Foreign associated companies:*

Cina, Francia, Germania, U.K., India, Portogallo, Singapore, Spagna, Rep. Ceca.

PRODOTTI | *PRODUCTS*

FCM: raccordi rapidi certificati MOCA per uso alimentare.

TECNO-RAP: raccordi rapidi completamente in tecno polimero.

INOX-SS: raccordi rapidi in acciaio inossidabile AISI316L.

RAP: raccordi rapidi in ottone nichelato. SERIE 100-400: raccordi di linea in ottone nichelato.

TUBO PER ARIA: tubo TPU, PA e PE.

FCM: food contact material push-in fittings.

TECNO-RAP: technopolymer push-in fittings.

INOX-SS: AISI316L stainless steel push-in fittings.

RAP: nickel plated push-in fittings.

100-400 SERIES: nickel plated standard fittings.

AIR TUBES: TPU, PA and PE tube.



➤ Raccordi automatici.
Push-in fittings.



➤ Raccordi a calzamento.
Quick fittings.



➤ Raccordi standard.
Standard fittings.



➤ Regolatori di flusso.
Flow regulators.



➤ Valvole e raccordi funzionali.
Functional valves and fittings.



➤ Rubinetti a sfera.
Ball valves.



TOSONI FLUIDODINAMICA SRL

Via F.lli Cervi 20 - 25030 Roncadelle (BS)
Tel +39 030 2584777 - Fax +39 030 2582212
www.tosoni.it
info@tosoni.it

PRESIDENTE | GENERAL MANAGER:
Mariangela Tosoni



FATTURATO | TURNOVER:
Euro 10.000.000,00



DIPENDENTI | EMPLOYEES:
40



ALTRE INFORMAZIONI | OTHER INFORMATION

Filiali | Branches:

Milano: V.le F. Testi 145 - 25092 Cinisello Balsamo MI
Bergamo: V.le Europa 52, 24048 Curnasco di
Treviolo BG

Controllate | Controlled Company:

- Oilcilindro Srl, Via Don Vittorio Bergomi 40/42, 25030 Castel Mella BS
- Produzione di cilindri ISO, saldati e speciali
- Aexi Srl, Via F.lli Cervi 127/b, 25030 Roncadelle BS
- Acquisizione digitale dati, sensori, controlli elettronici e in remoto

Certificazioni | Certifications:
UNI EN ISO 9001:2015

PRODOTTI | PRODUCTS

Progettazione, realizzazione e installazione di impianti a fluido per industria e infrastrutture, manutenzione e messe in sicurezza, banchi prova e collaudo, cilindri e componenti specifici personalizzati, controlli elettronici. Ampia gamma di disponibilità dal pronto di ricambi per oleidraulica, pneumatica, lubrificazione e accessoriata.

Design, construction and installation of fluid systems for industry and infrastructures, maintenance and safety measures, test and testing benches, cylinders and specific customized components, electronic controls. Wide range of stock of spare parts for hydraulic, pneumatic, lubrication and accessories.



➤ Esempio di impianto customizzato.
Example of customized system.

➤ Filiali Bergamo e Milano.
Branches of Bergamo and Milan.



➤ Cilindri ISO, saldati o a disegno.
ISO cylinders, welded or according to drawing.



**TRACEPARTS SRL**

Via Aristotele 109 - 42122 Reggio Emilia (RE)

Tel + 39 0522 391727

www.traceparts.com - info@traceparts.it

AMMINISTRATORE DELEGATO DIVISIONE ITALIANA |*MANAGING DIRECTOR ITALIAN BRANCH:*

Ing. Nino Mazza

**FATTURATO | TURNOVER:**

Euro 22.675.400,00

**DIPENDENTI | EMPLOYEES:**

221

**ALTRE INFORMAZIONI | OTHER INFORMATION**

- TraceParts SA (Head Quarter) Parc Eco Normandie 76430 Saint Romain, France, Tel +33 0232794426
- TraceParts America LLC 3814 West Street, Suite 203 Cincinnati, OH 45227, USA, Tel +1 513 460 - 9950
- TraceParts GmbH, Fuggerstrasse 9 A, D-92224 Amberg, Germany - Tel + 49 (0) 9621 91730
- TraceParts China, Ltd No.1717 Hutai Road, Floor 2, 238, Baoshan District, Shanghai 200436, China - Tel +86/21/56555112
- TraceParts Brasil, Rua Rio Grande do Norte, 1436 - Sala 1605 - Savassi Belo Horizonte - Minas Gerais, CEP 30.130-138, Brazil Tel +55 (31)40425588
- Normsoft A.S. - TraceParts Turkey: Uğurmumcu 34882 Kartal/Istanbul, Turkey Tel +90 224 999 53 07

H

P

M



AZIENDA | COMPANY

Fondata nel 1992, TraceParts è un'importante risorsa per aziende e disegnatori meccanici, fornendo servizi di catalogazione e digitalizzazione con la tecnologia Multi-CAD. I suoi dati di alta qualità consentono l'inserimento semplice di prodotti in assiemi CAD nativi. Il TraceParts Publishing Network, con oltre 29 milioni di utenti globali, offre modelli 3D di componenti. Mantenendo la riservatezza dei dati sensibili, fornisce solo le informazioni essenziali ai progettisti, salvaguardando la proprietà intellettuale. Ciò facilita l'integrazione dei prodotti

nei progetti e garantisce una trasmissione senza problemi attraverso il processo di progettazione fino alla distinta materiale. TraceParts, risorsa chiave per aziende e disegnatori meccanici, offre servizi di catalogazione e digitalizzazione con tecnologia Multi-CAD. Il suo network, con oltre 29 milioni di utenti globali, fornisce modelli 3D di alta qualità. Mantenendo riservatezza sui dati sensibili, fornisce informazioni essenziali, facilitando l'integrazione dei prodotti nei progetti e garantendo una trasmissione fluida attraverso il processo di progettazione.

➤ TraceParts è il primo portale mondiale di componentistica, gestendo oltre 32 piattaforme e servendo 29 milioni di utenti. Offre un vasto assortimento di componenti per ingegneri, designer e professionisti dell'industria, facilitando l'accesso a dati tecnici e modelli CAD di alta qualità.

➤ TraceParts attrae una vasta audience nel settore metalmeccanico e industriale, fornendo risorse cruciali per ingegneri, progettisti e professionisti della produzione.

➤ Tutte le categorie di componentistica su TraceParts ricevono un notevole numero di download, evidenziando la vastità dell'utilizzo e l'interesse degli utenti.

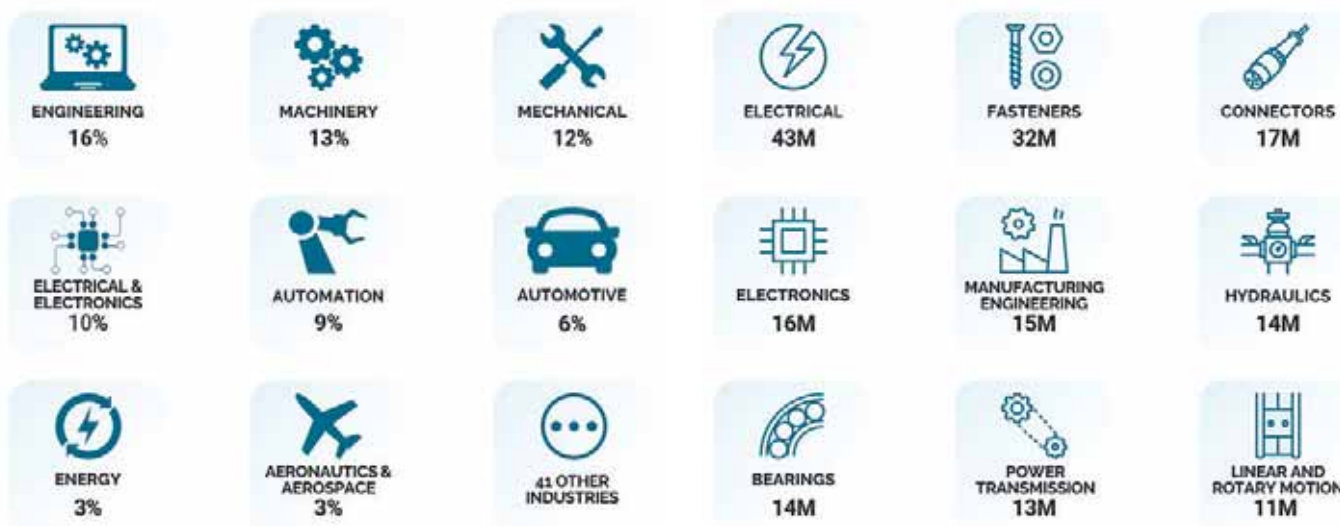

PRODOTTI | PRODUCTS

- Creazioni cataloghi e configuratori 3D.
- Gestione di 31 portali di componentistica meccanica con 29 milioni di utenti.
- Servizi di Digital Marketing.
- Servizi di modellazione multiCAD.
- Sviluppo software.
- Software per la gestione della manualistica (Autodoks), delle parti di ricambio e dell'eCommerce aziendale (SCS).



- TraceParts Analytics, basato su Google Analytics, aiuta le aziende a raccogliere e analizzare i lead provenienti dalla pubblicazione dei cataloghi. Fornisce dati dettagliati sul comportamento degli utenti, consentendo alle aziende di valutare l'efficacia delle proprie strategie di marketing e migliorare l'engagement con i clienti.

- TraceParts gestisce il TraceParts Publishing Network, garantendo una presenza globale. L'acquisizione del portale Thomasnet, leader nel settore negli USA, ha rafforzato ulteriormente questa posizione.

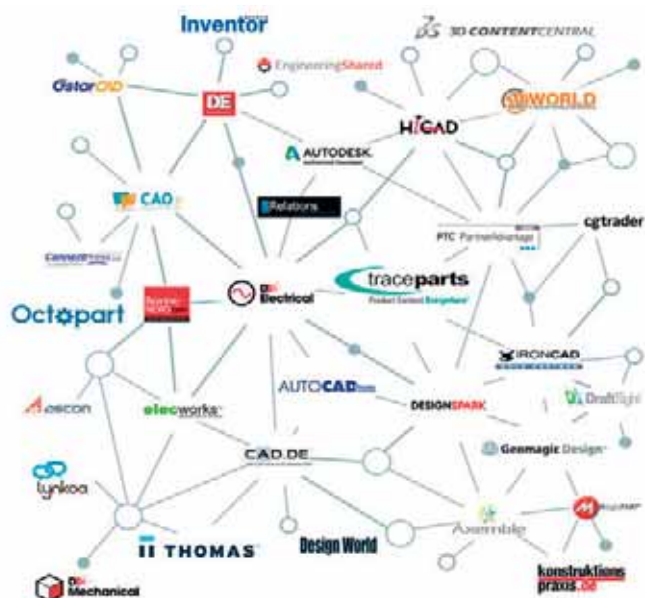

- L'interfaccia di TraceParts Analytics è ottimizzata per l'accesso da dispositivi mobili, garantendo una fruizione fluida e intuitiva.



DIGITAL MARKETING SERVICES (DMS):

La diffusione globale di TraceParts ha permesso di raccogliere migliaia di informazioni da progettisti, uffici tecnici e uffici acquisti, che rappresentano preziosi leads. Oltre a essere uno strumento di progettazione, TraceParts è un'importante risorsa per ottenere aggiornamenti nel settore e trovare nuovi fornitori.

SPAREPARTS CATALOG SERVICES (SCS):

Automatizza grazie ai nostri Software la gestione del tuo catalogo ricambi e del tuo eCommerce. Grazie alla soluzione SCS possiamo creare disegnare il tuo perfetto eCommerce integrato perfettamente con il tuo gestionale e progettato in maniera dettagliata sulla base delle tue esigenze.

AUTODOKS:

È il cuore del sistema di Editor Technology Consulting non un semplice programma di impaginazione automatica, ma uno strumento di sintesi fra due mondi fino ad oggi separati, quello dei sistemi CAD e della grafica e del publishing. Autodoks automatizza il processo elaborando in maniera autonoma la creazione di manuali in oltre 27 lingue, facendo risparmiare nel processo oltre il 70% del tempo.



- TraceParts offre servizi di catalogazione e operazioni di marketing in piena conformità con la normativa sulla privacy. I suoi 950.000 utenti hanno scelto di ricevere comunicazioni, garantendo un'interazione consensuale e conforme alla normativa.

- AutoDoks grazie al suo plug-in può dialogare in maniera automatica ed integrata con tutti i principali sistemi CAD. Questo rende AutoDoks, flessibile, efficiente ed estremamente stabile. Tutta la manualistica può essere realizzata in oltre 27 lingue con pochi click.

- AutoDoks trasforma il modo in cui le aziende affrontano le sfide della documentazione tecnica e commerciale. Con la nostra piattaforma innovativa, garantiamo conformità, sicurezza ed efficienza, trasformando un compito complesso in un vantaggio competitivo.

Plug-in Autodoks 2025:
L'innovativa applicazione che crea un collegamento diretto tra il modulo exploded di Inventar ed il documento finale

Piena compatibilità con i principali sistemi CAD

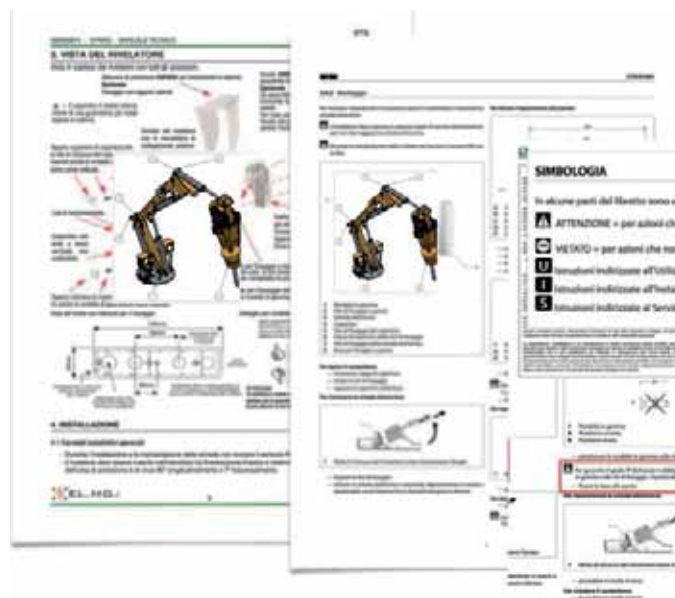



ALTRE INFORMAZIONI | OTHER INFORMATION

UFI Filters Hydraulics è presente in più di 60 paesi con una rete di distribuzione ben radicata sul territorio e con filiali dirette in Australia, Brasile, Cina, Corea, Germania, India e Stati Uniti.

UFI Filters Hydraulics is present in more than 60 countries with a network of qualified distributors and with branch offices in Australia, Brazil, China, Korea, India, Germany and United States.

PRODOTTI | PRODUCTS

Da oltre 30 anni, UFI Filters Hydraulics è specializzata nella **progettazione, produzione e commercializzazione di una linea completa di filtri oleodinamici, elementi filtranti ed accessori affidabili e ad alta efficienza, per applicazioni mobili e stazionarie**, quali movimentazione del materiale, costruzioni, applicazioni agricole e industriali, mezzi pesanti e produzione di energia eolica. La gamma di UFI Filters Hydraulics comprende inoltre una vasta linea di elementi intercambiabili con oltre 48.000 referenze.

UFI Filters Hydraulics is specialised in the design, manufacture and sale of hydraulic filters, filter elements and accessories for mobile and stationary applications, as material handling, construction, agricultural and industrial applications, heavy duty and wind power generation. UFI Filters Hydraulics catalogue includes a wide range of interchangeable filter elements with more than 48.000 references.



UFI FILTERS HYDRAULICS SPA
Via S. Chierico 24 - 24060 Bolgare (BG)
Tel +39 035 4493811 - Fax +39 035 843743
www.ufihyd.com
info.ufihyd@it.ufifilters.com

AMMINISTRATORE | MANAGING DIRECTOR:
Cesare Grassi

FATTURATO | TURNOVER:
Euro 22.967.000,00

DIPENDENTI | EMPLOYEES:
72

H
P
M

- Filtri in aspirazione. Protezione ottimale dell'impianto.
Suction filters. Optimal protection of your pump.



- Filtri in pressione. Filtrazione ad alta efficienza.
Pressure filters. High efficiency filtration.



- Filtri sul ritorno. Salvaguardia della pulizia del fluido.
Return filters. Safeguards fluid cleanliness.



- Filtri di ricircolo. Trasferimento sicuro del fluido.
Off-line filters. Flushing and fluid transfer.



- Filtri per trasmissioni. Combinati aspirazione e ritorno.
Transmission filters. Combined return & suction.



- Filtri aria. Contro la contaminazione atmosferica.
Air filters. Against atmosphere contamination.



- Accessori. Gamma completa, alta qualità.
Accessories. Comprehensive choice, high quality standard.



- Indicatori di intasamento. A supporto del tuo impianto.
Clogging indicators. Vital support for your system.



- Elementi filtranti intercambiabili. Massima performance.
Alternative filter elements. Maximum performance.



**VARVEL SPA**

Via 2 Agosto 1980, 9
40056 Valsamoggia (BO)
Tel +39 051 6721811 - Fax +39 051 6721825
www.varvel.com - varvel@varvel.com

AMMINISTRATORE DELEGATO | CEO:

Mauro Cominoli

**FATTURATO | TURNOVER:**

Euro 32.000.000,00

**DIPENDENTI | EMPLOYEES:**

92

**ALTRE INFORMAZIONI | OTHER INFORMATION****Filiali | Branches:**

India, USA

Distributori | Distributors:

Varvel è presente in più di 60 paesi in cinque continenti con una rete commerciale e distributiva accuratamente selezionata e consolidata nel corso degli anni.

Varvel has operations in more than 60 countries on five continents with a sales and distribution network consolidated over the years.

PRODOTTI | PRODUCTS

Dal 1955 il Gruppo Varvel offre una gamma di riduttori e motoriduttori progettati e prodotti in Italia adatti per applicazioni fisse di piccola e media potenza.

Affidabili, resistenti ed efficienti, i prodotti Varvel sono versatili ed adatti a qualsiasi utilizzo nei numerosi settori industriali.

I riduttori Varvel sono integrabili in qualunque macchina esistente e compatibili con tutte le misure richieste dai costruttori.

Since 1955 the Varvel Group offers a range of gearboxes and gearmotors, all designed and made in Italy, for low and medium power, fixed applications.

Reliable, tough and efficient, Varvel products are versatile and able to satisfy the needs of numerous areas of industry.

Varvel gearboxes integrate in all types of machine and are fully compatible with the dimensional standards required by machine manufacturers.



- Riduttori coassiali con elevato rendimento e struttura modulare.
In-line helical gearboxes with high efficiency and modular structure.

- Riduttori a vite senza fine per applicazioni che richiedono piccole o medie potenze.
Worm gearboxes for applications requiring small or medium power.

- Riduttori ad assi paralleli e ortogonali.
Parallel shaft and helical-bevel helical gearboxes.





VERZOLLA



VERZOLLA SRL

Via Brembo 13/15 - 20900 Monza (MB)
Tel +39 039 21661 - Fax +39 039 2103010
www.verzolla.com
verzolla@verzolla.com

PRESIDENTE | GENERAL MANAGER:

Paolo Mambretti



ALTRE INFORMAZIONI | OTHER INFORMATION

Sul mercato dal 1958, disponiamo di un efficiente rete di distribuzione di prodotti e servizi per l'industria. L'organizzazione si basa su unità distributive dislocate sul territorio e coordinate dal centro logistico di Monza. I prodotti offerti si articolano nelle linee, cuscinetti, movimentazione lineare, trasmissioni di potenza, oleodinamica, pneumatica, utensileria.

On the market since 1958, we have an efficient distribution network of products and services for the industry. The organization is based on distribution units located throughout the area and coordinated by the Monza logistics center. The products offered are divided into lines, bearings, linear movement, power transmissions, hydraulics, pneumatics, tools.

PRODOTTI | PRODUCTS

Cuscinetti SKF, supporti, lubrificazione, guide lineari, viti a ricircolo, motori elettrici, motoriduttori, giunti, cinghie e pulegge, pignoni e catene, centraline oleodinamiche, tubi e raccordi per alta pressione, valvole e cilindri per olio, motori idraulici, compressori, valvole e cilindri per aria componenti pneumatici, utensileria, adesivi industriali, utensili da taglio, attrezzature per officina.

SKF bearings, housings, lubrication, linear guides, recirculating screws, electric motors, gearmotors, joints, belts and pulleys, sprockets and chains, hydraulic power packs, high pressure pipes and fittings, valves and cylinders for oil, hydraulic motors, compressors, air valves and cylinders for pneumatic components, tools, industrial adhesives, workshop equipment.





➤ Cuscinetti.
Bearings.



➤ Movimentazione lineare.
Linear motion.



➤ Trasmissioni di potenza.
Power transmission.



➤ Oleodinamica.
Hydraulic.



➤ Pneumatica.
Pneumatic.



➤ Utensileria.
Tools.



ALTRE INFORMAZIONI | OTHER INFORMATION

Oggi l'azienda è presente in tutte le realtà industriali più significative del mondo grazie a distributori e partners locali, tecnologicamente preparati e pronti a supportare il cliente nella definizione della soluzione più adeguata alla specifica necessità.

Today the company works in the most significant industrial realities thanks to its distributors and local partners who are technologically prepared and ready to support the client in defining the best solution for their specific needs.

PRODOTTI | PRODUCTS

- Ventose
 - Portaventose
 - Strumenti di misura, di controllo e di regolazione del vuoto
 - Valvole ed elettrovalvole per vuoto
 - Filtri d'aspirazione
 - Raccorderia e tubazioni per il vuoto
 - Pompe per vuoto e depressori
 - Generatori di vuoto e depressori pneumatici
 - Sistema di presa a depressione OCTOPUS
 - Graphic Division
 - Esecuzioni speciali.
-
- Vacuum cups
 - Vacuum cup holders
 - Instruments for vacuum measurement, checking and adjustment
 - Vacuum valves and solenoid valves
 - Suction filters
 - Fittings and hose for vacuum
 - Vacuum pumps and pumpset
 - Vacuum generators and pneumatic pumpsets
 - The OCTOPUS Vacuum Lifting System
 - Graphic Division
 - Multi-function vacuum generators.



VUOTOTECNICA SRL

Via Como 146/A - 23883 Beverate di Brivio (LC)
Tel +39 039 5320561/106 - Fax +39 039 5320015
www.vuototecnica.net - www.vacuumdaily.com
info@vuototecnica.net

AMMINISTRATORE | MANAGING DIRECTOR:

Giuliano Bosi



FATTURATO | TURNOVER:

Euro 7.300.000,00



DIPENDENTI | EMPLOYEES:

20

- Ventose Maxigrip per lamiere/automotive e non solo.
Maxigrip cups for sheet metal/automotive and beyond.



- Generatori di vuoto pneumatici multifunzione MSVE.
Multifunction pneumatic vacuum generators MSVE.



- Ventose BEC per sollevare oggetti irregolari.
BEC suction cups for lifting irregular objects.



- Vacumanager - unità elettro-pneumatica per eiettori del vuoto.
Vacumanager - electro-pneumatic unit for vacuum ejectors.



- Vacupredator per prese e manipolazioni di sacchi.
Vacupredator for gripping and handling of bags.



- Piani PH e P2H per la pallettizzazione e de-pallettizzazione.
PH and P2H suction tables for palletizing and de-palletizing.



- Filtri di aspirazione in linea FCL per trattenere le impurità.
FCL in-line suction filters to retain impurities.



- Riduttori di vuoto da 2" e 3" gas per regolare il grado di vuoto.
2" and 3" gas vacuum regulators to adjust the vacuum level.



- Visita il nostro sito.
Visit our website.



**ALTRE INFORMAZIONI** | OTHER INFORMATION

Unità produttiva | *Productive unit:*
20070 Vizzolo Predabissi (MI) - Via Piemonte 22

PRODOTTI | PRODUCTS

Cilindri a norme. Unità di guida. Bloccastelo. Fissaggi. Sensori magnetici e accessori. Elettrovalvole azionamento diretto. Valvole azionamento pneumatico ed elettropneumatico, a spola e ad otturatore, a norme, multipolare e per vuoto. Tecnologia proporzionale. Bobine e connettori. Valvole e minivalvole. Logica pneumatica. Regolatori di portata. Trattamento aria F.R.L. Pressostati. Raccordi e tubi. Atex.

Standardized cylinders. Guide units. Piston-rod locking unit. Fixings. Magnetic sensors and accessories. Direct acting solenoid valves. Pilot and solenoid actuated valves with spool or poppet design, standardized and fit for multi-pin connection and vacuum. Proportional technology. Coils and connectors. Mechanical, manual, pedal valves and minivalves. Pneumatic logic elements. Flow regulators. F.R.L. Air treatment. Pressure switches. Fittings and tubes. Atex.

**WAIRCOM MBS SPA**

Via Piemonte 13/15 - 20070 Vizzolo Predabissi (MI)
Tel +39 02 98230801/21 - Fax +39 02 98230830
www.waircom-mbs.com
info@waircom-mbs.com

AMMINISTRATORE DELEGATO | CEO:

Dott.ssa Raffaella Bertola

**DIPENDENTI** | EMPLOYEES:

50

H

P

M

- Elettrovalvole ad azionamento diretto.
Direct acting solenoid valve.



- Valvole a spola. Azionamento pneumatico ed elettropneumatico.
Spool valves pilot and solenoid actuated.



- Batterie di valvole multipolare.
Manifold mounting of valves with multi-pin connection.



- Cilindri INOX a profilo tondo.
Stainless steel round cylinders.



- Cilindri a norma ISO 15552.
Cylinders to ISO 15552 standard.



- Cilindri rotanti.
Rotary cylinders.



- Trattamento aria F.R.L.
Air treatment F.R.L.



- Valvole proporzionali di pressione.
Pressure proportional valves.



- Valvole ad azionamento a pedale.
Valves pedal actuated.





Nuovo Innovation Center Walvoil. | New Walvoil Innovation Center.



Prove su campo. | Test on field.

**WALVOIL SPA**

Via Adige, 13/D - 42124 Reggio Emilia (RE)
Tel +39 0522 932411 - Fax +39 0522 300984
www.walvoil.com
info@walvoil.com

AMMINISTRATORE DELEGATO | CEO:

Fabio Marasi

**FATTURATO | TURNOVER:**

Euro 324.000.000,00

**DIPENDENTI | EMPLOYEES:**

1.500

**ALTRE INFORMAZIONI | OTHER INFORMATION****Società estere | Subsidiaries:**

- WALVOIL FLUID POWER CORP.
Tulsa (Oklahoma), Red Wing (Minnesota) - Usa.
- WALVOIL FLUID POWER (INDIA) Pvt. Ltd.
Attibele, Bangalore.
- WALVOIL FLUID POWER (DONGGUAN) CO. Ltd.
Dongguan City, Guangdong Province - China.
- WALVOIL FLUID POWER KOREA LTD.
Pyungtaek, Kyungki.
- WALVOIL CANADA INC. - Terrebonne.
- WALVOIL FLUID POWER FRANCE
Vritz, Vallons-De-L'Erdre.
- INTERPUMP HYDRAULICS BRASIL LTDA
WALVOIL DIVISION - Caxias do Sul (RS).
- WALVOIL FLUID POWER AUSTRALASIA PTY LTD - Melbourne.

AZIENDA | COMPANY

Dal 2015, in seguito all'acquisizione da parte di Interpump Group, Walvoil rappresenta la 'Valves Division' del settore "Olio", del Gruppo. Cresciuta con l'intento di progettare il futuro del movimento, da oltre cinquant'anni propone un'offerta integrata di prodotti oleodinamici, elettronici e sistemi meccatronici che la qualificano tra le aziende leader del settore a livello mondiale. È presente in Italia nelle provincie di Reggio Emilia e Bologna, cluster della meccanica e della meccatronica nazionale, con sei sedi produttive ed un Innovation Center, che è il cuore di tutte le attività di Ricerca & Sviluppo dell'azienda e del Gruppo Walvoil.

Since 2015, following the acquisition by Interpump Group, Walvoil has represented the 'Valves Division' of the Group's 'Hydraulics' sector. Grown with the intention of designing the future of motion, for over fifty years it has been offering an integrated range of hydraulic, electronic and mechatronic products and systems, that qualify it among the leading companies in the sector worldwide. It is present in Italy in the provinces of Reggio Emilia and Bologna, clusters of the national mechanical and mechatronics industry, with six production sites and an Innovation Center, which is the heart of all the Research & Development activities of the company and the Walvoil Group.

PRODOTTI | PRODUCTS

Distributori monoblocco, componibili, Load-Sensing pre-compensati e Flow Sharing. Pompe e motori ad ingranaggi. Divisori di flusso. Applicazioni speciali. Cartucce cavità SAE. Valvole con corpo. Valvole bancabili a comando diretto. Deviatori di flusso. Circuiti idraulici integrati. Unità di alimentazione. Servocomandi idraulici, pneumatici e meccanici a cavo flessibile. Sistemi elettronici PHC. Joystick. Impugnature. Centraline.

Monoblock, sectional, Pressure pre-compensated Load-Sensing and Flow Sharing valves. Gear pumps and motors. Flow Dividers. Special applications. SAE cavity cartridges. Hydraulic valves. Bankable solenoid valves. Diverter valves. Hydraulic integrated circuits (HICs). Hydraulic & Pneumatic pilot control valves. Flexible cable remote controls. Feed units. PHC electronic systems. Joysticks. Handles. Electronic control units.



➤ **Distributori Oleodinamici.** Componenti elettronici e sistemi PHC.
Directional Control valves. Electronic components & PHC systems.

➤ **Idraulica compatta e Servocomandi.**
Compact Hydraulics & Remote Controls.



➤ **Pompe e motori ad ingranaggi,** in alluminio e in ghisa.
Gear pumps and motors available in aluminium and cast iron.





PRODOTTI | PRODUCTS

Tubi termoplastici e PTFE a media, alta ed altissima pressione per applicazioni oleodinamiche, lubrificazione, solventi, vernici, gas, refrigerazione, prodotti chimici ed alte temperature rispondenti alle principali normative internazionali SAE, ISO, EN; raccordi a pressare e recuperabili. Tubi capillari per il collegamento di apparecchiature di rilevamento pressione. Gamma completa di tubi e spirali a bassa, media pressione per comandi oleopneumatici in Rilsan PA11, PA12, poliammide 6, Hytrel, PU, PE e PTFE. Tipi speciali sono realizzati su specifica richiesta.

Medium, high and very high pressure thermoplastic hoses and PTFE for hydraulic applications, lubrication, solvents, paint spray, gas, refrigeration, chemical products and high temperature according to the main international standards SAE, ISO, EN. Swaged and reusable fittings. Capillary hoses made for the connection of working pressure survey equipments. Complete range of low, medium pressure tubes and spirals for oilpneumatic controls in Rilsan PA11, PA12, polyamide 6, Hytrel, PU, PE and PTFE. Special types are realized on particular requests.



THERMOPLASTIC TUBING AND HOSES

H

P

M



ZEC SPA

Strada Lungolorno 11 - 43052 Colorno (PR)
Tel +39 0521 816631 - Fax +39 0521 816772
www.zecspa.com - info@zecspa.com

PRESIDENTE | GENERAL MANAGER:
Eugenio Zantelli

DIRETTORE | MANAGING DIRECTOR:
Dino Zantelli



FATTURATO | TURNOVER:
Euro 43.500.000,00



DIPENDENTI | EMPLOYEES:
160

- Tubi flessibili termoplastici e PTFE a media, alta e altissima pressione - Raccordi.
Medium, high and very high pressure flexible thermoplastic and PTFE hoses - Fittings.



- Tubi flessibili termoplastici e PTFE a bassa pressione.
Thermoplastic and PTFE low pressure flexible tubing.



- Tubi Flessibili Termoplastici e Raccordi per Refrigerazione.
Thermoplastic Hoses and Refrigeration Fittings.





www.federtec.it



Viale Fulvio Testi 128
20092 Cinisello Balsamo (MI)

Tel +39 02-29010411

Tel +39 02-6570266

federtec@federtec.it



federtec.it