



盾牌筛网 坚固耐磨

DUNPAI SCREENS ROBUST AND WEAR RESISTANCE

企业简介

Introduction

我公司原名上海前哨矿筛厂，成立于1973年。原系国有企业。1998年改制为股份合作制企业。现发展为一个销售公司、三个制造公司。上海盾牌筛网经营部经营销售各生产公司的产品；上海盾牌矿筛有限公司以生产耐磨钢丝编织筛网、冶金行业悬臂筛网、陶瓷筛板、各种非金属筛网为主；上海盾牌筛网滤器有限公司以生产不锈钢条缝筛板、筛篮、各种非标过滤器为主；上海上盾筛分设备有限公司以生产各种筛分机械、金属结构件为主。

公司生产的各类筛网，畅销国内二十多个省市、自治区，广泛用于冶金、矿山、化工、石料、筑路、隧道等行业的物料分级和过滤，大量替代进口产品，深得用户好评。公司有自己的产品标准，也参与国内标准修订工作。出口产品采用ISO标准，大部份产品达到国内先进水平。

公司注册的“盾牌”商标为上海市著名商标，公司生产的产品获得多项专利。质量及使用周期明显优于国内同类产品。

公司的产品从1985年开始，进入全国重点钢铁企业，全面代替了从日本、德国引进设备的配套筛网，满足了现代化生产要求。如今，上海盾牌筛网的产品在宝钢、马钢等多家钢铁厂使用。

在筑路行业方面，公司制造的各种筛网全面代替了从英、美、德、日、意、韩等过引进的沥青拌合楼的专用筛网，满足了各种高级公路的级配要求。

公司生产的高强度不锈钢无磁焊接筛板、弧形筛板、离心机筛篮等由于其质量可靠、性能稳定，得到广泛应用。公司产品的棱面形高效筛板，脱水效率高，耐磨性能优越，焊接强度高（采用氩弧焊焊接），筛分精确，得到用户的高度认可。

公司还有承接国内外各种筛分设备的维修和改造。

公司有严格的从销售、设计、制造、检测到售后服务等全过程的质量监控体系，力求达到产品质量无缺陷，完美的售后服务使客户无后顾之忧。公司热情为客户测绘、设计、试制各种新产品。

Our company was established in 1973 and formerly known as the name of Shanghai QianShao Screen Factory and it was run by state-owned enterprise. Since 1998, it has been reconstituted into joint-stocked cooperation enterprise. Now it has developed into four divisions: Sales Division, and the other three manufacturing factories, they are: Shanghai Dunpai Screen Sales Division is mainly responsible for developing markets; Shanghai Dunpai Mineral Grid Limited Co. mainly produces wear-resistant wire weave meshes, cantilever screens, ceramic screen and a variety of non-metallic screens; Shanghai Dunpai Wire Mesh & Filtering Limited Co. mainly produces SS(stainless steel) slotted screens, screen baskets and non-standard filters; Shanghai Shangdun Sizing Equipment limited Co. mainly produces all kinds of vibrating machine and metal structural hardwares.

Many of Dunpai screens and meshes are popularized to be used in sizing and filtering industry markets of metallurgies, mining, chemical industry, quarry, road construction, tunneling projects and so on, some products are to be used as the substituted products for imported screens and meshes which are happy with our customers. Dunpai has own product standards, and we are also taking a part in revision work of domestic standards system in Sizing Industry. Dunpai is producing exported products applied with ISO standards and most of them are reached to high-level quality in markets.

DUNPAI is registered as the well-known trademark in Shanghai, and many patents are registered and granted, some items are much better than other similar domestic products either in its quality and life expectancy.

DUNPAI has entered into Steel Industry market since 1985, and some products are substituted for a complete set of screens originated in Japan, Germany, they are totally met with the current iron production requirements, such as, Bao Steel Group and Maanshan Steel Company, etc. of national key Iron industries.

In road construction industry, Dunpai's screens and meshes have been entirely substituting those specific screens and meshes of asphalt mixing equipments from UK,US, Germany, Japan, Italy and Korea, etc. and they are satisfied with a different level of road building requirements in superior road construction.

Dunpai's high-strength SS(stainless steel) non-magnetic welding screen boards, curved screen plates and centrifuge SS baskets are widely applied due to its reliable quality and stability performance, and Dunpai's ridged-surface screens are highly gained recognition by customers with its high efficiency, efficient dewatering, super wear-resistant performance, high welding strength(TIG welding type) and accurately sizing.

DUNPAI also undertakes maintenance and modification jobs on sizing equipments imported from foreign countries and China.

DUNPAI has a complete of strict quality control systems from sales, engineering, manufacturing and inspection to after-sale service, non-defect products and perfect service to our customers is our goal.



盾牌筛网 坚固耐磨

DUNPAI SCREENS ROBUST AND WEAR RESISTANCE

目 录 Contents

上海盾牌筛网经营部：

- 经营下面三个公司的产品

上海盾牌矿筛有限公司：

- 耐磨钢丝编织网
- 冶金工业筛网
- 非金属筛网
- 振动筛机配件

上海盾牌筛网滤器有限公司：

- 条缝筛板及筛篮
- 过滤器

上海上盾筛分设备有限公司：

- 振动筛机
- 旋振筛

Shanghai Dunpai Sales Division

- Managing products of DUNPAI's three affiliated companies

Shanghai Dunpai Mineral Grid Co.,Ltd

- Wear weaving mesh
- Metallurgical screen
- Non-metallic screen
- Accessories of vibratang machine

Shanghai Dunpai Wire Mesh&Filtering Co.,Ltd

- Slotted SS plate and Centrifuge SS Basket
- Filters

Shanghai ShangDun Sizing Equipment Co.,Ltd

- Virbating machine
- Rotary Vibrating machine



盾牌筛网 坚固耐磨

DUNPAI SCREENS ROBUST AND WEAR RESISTANCE

上海市著名商标和品牌产品证书 Certifications of Well-known Trade Mark and Brand Product in Shanghai



专利证书 Patent Certifications





盾牌筛网 坚固耐磨

DUNPAI SCREENS ROBUST AND WEAR RESISTANCE

可靠的质量保证

- 原料 - 半成品 - 成品全程监控
- 完善、健全的操作流程和质量控制体系
- 精良的生产设备
- 全面、有效的 ISO9001 体系，保证产品质量一流
- ISO14000 体系确保产品的环境保护项目达标

用户至上的服务理念

- 按照用户的个性化需求设计 / 制造产品
- 提供疑难问题技术咨询及拟定合适的实施方案
- 快速应对体系保障用户利益
- 细致的用户随访，及时和用户互动，适应用户需求

Reliable Quality Warranty

- All the way of supervision from resources, semi-products to final products
- Complete and perfect operation process and quality control system
- Excellent equipment
- First-class quality guaranteed under ISO9001 system control
- Products protected under ISO14000 system

Commitments To Our Customers

- Tailored solutions to satisfy with customer requirement
- Providing technical consultants on the hardest problems and making out an appropriate solutions
- Protecting customer's interest from the prompt responding system
- Carefully visit and contact customers timely to meet customer's requests

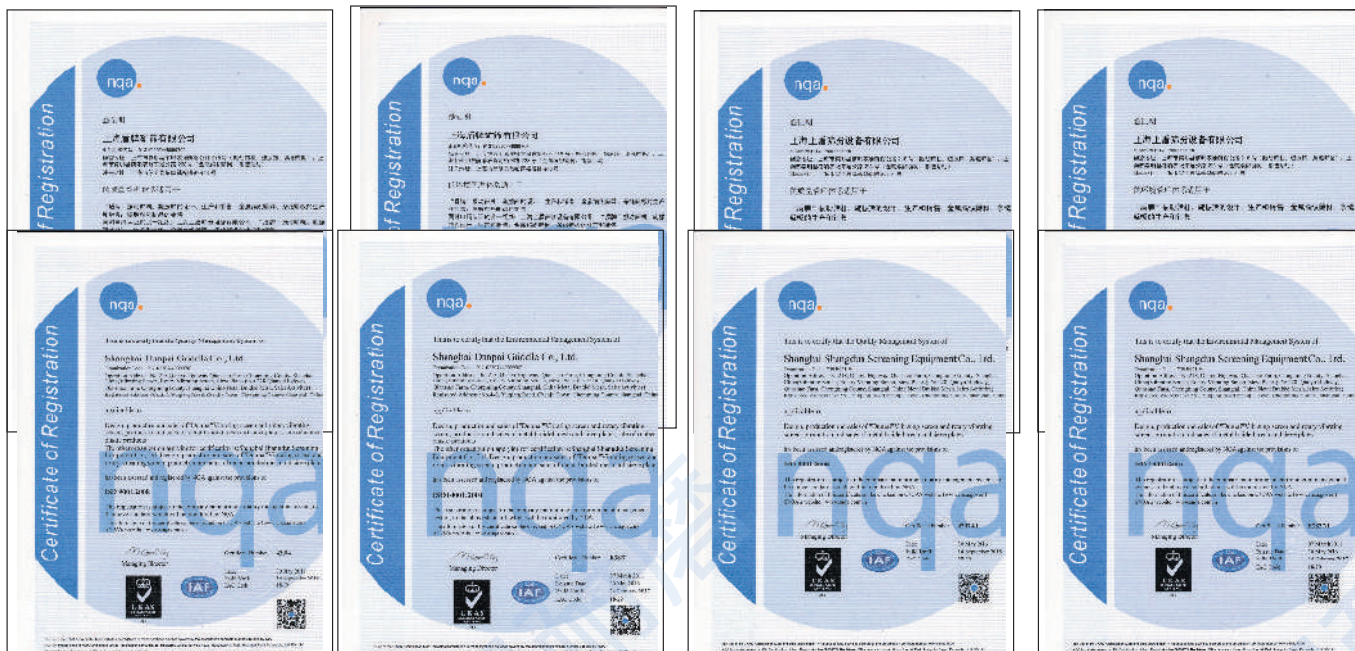

出口资质证书 Export Qualification

采购证书 Purchase Authority





盾牌筛网 坚固耐磨

DUNPAI SCREENS ROBUST AND WEAR RESISTANCE

上海盾牌矿筛有限公司

SHANGHAI DUNPAI MINERAL GIRD CO.,LTD

耐磨钢丝编制筛网 Wear Weaving Mesh

我公司专业生产各种沥青拌合楼的配套筛网及各种振动筛机用筛网和配件，质量管理按 ISO 质量体系标准，采用耐磨材料、特殊工艺编织。近年开发各种防堵筛网广泛应用于临界堵孔、糊网、粘性物料堵孔筛分，并且申请了专利。

公司为全国基本建设单位生产各种沥青拌合楼专用筛网，隧道建设单位配套脱水筛板质量可靠，深得用户好评。其主要特点是筛网耐磨性优异，防堵网的防堵性能好，使用周期长。满足各种公路级配要求。隧道建设中筛板脱水效果好、寿命长、完全替代了进口产品。

近年来，公司生产设计的各种筛网，已经获得了多项专利。

公司代为测绘、设计、试制各种特殊筛网，并且为用户提供各种技术服务。

Dunpai manufactures all kinds of screens served for asphalt mixing plants, and vibrating screening machines, all products are controlled abiding by ISO standard, adopted with anti-abrative material and woven by special weaving process. The anti-clogging screens are widely used in the situation, such as, critical plugging, sticky and muddy material. The screen has been registered as patent.

Dunpai has been supplying with a variety of screens for asphalt mixing plants in national-wide highway construction projects, as well as a complete set of de-watering screen boards for tunneling companies, they are all well confirmed by our customers with its excellent wear resistance, anti-clogging performance and long operation life, and they are also able to satisfy with requirements specified in all grades of road construction. In terms of screens in de-watering machines for tunneling projects, they can be substituted as imported parts due to its best dewatering work and good life. A quite few of screens in the above fields have been granted and registered as patents in recent years.

We are very welcomed to map, design and test any special screens if needed and provide technical services to our customers.

A 型 - 双向弯曲筛网 Type A: Double-way Curved Mesh

GW-1

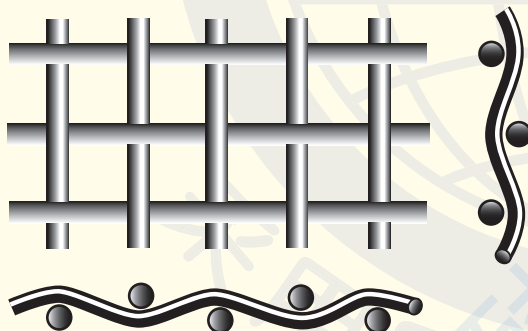

B 型 - 双向弯曲筛网 Type B: Single-way Separated Curved Mesh

GW-2

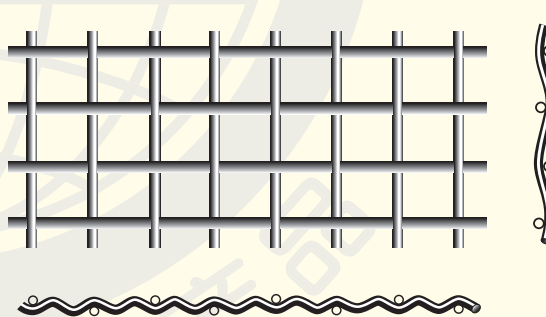

C 型 - 双向隔波弯曲筛网 Type C: Double-way Separated Curved Mesh

GW-3

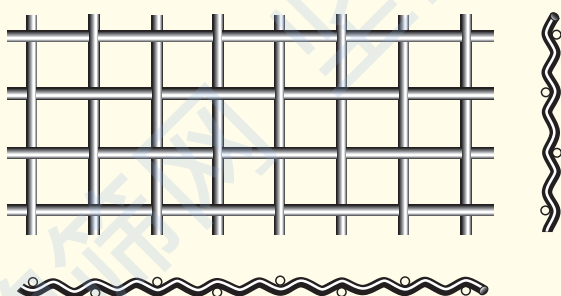

D 型 - 锁定 (定位) 弯曲筛网 Type D: Positioning Curved Mesh

GW-4

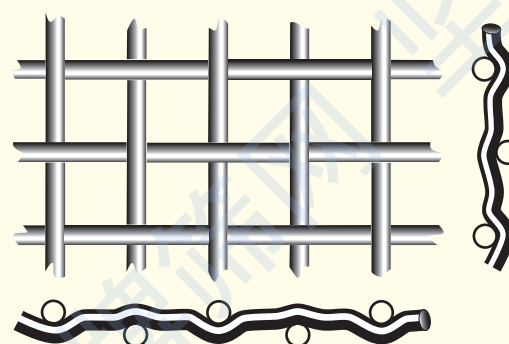



盾牌筛网 坚固耐磨

DUNPAI SCREENS ROBUST AND WEAR RESISTANCE

上海盾牌矿筛有限公司

SHANGHAI DUNPAI MINERAL GIRD CO.,LTD

E 型 - 平顶弯曲筛网 Type E: Flat-topped Curved Mesh

GW-5

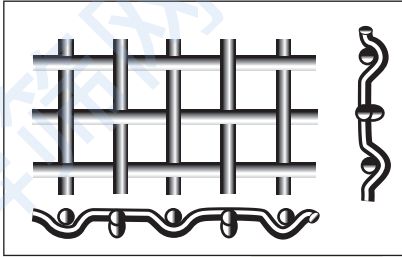

长方孔筛网 Rectangular Aperture Mesh

GW-6

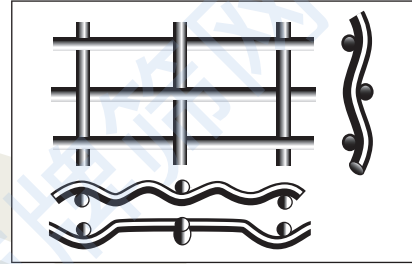

复合肥筛网 Wire Mesh for Compound Fertilizer

GW-7

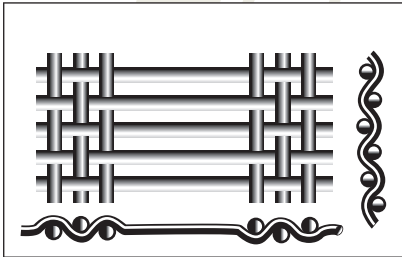

琴弦防堵筛网 String Type Anti-clogging Mesh

GW-8

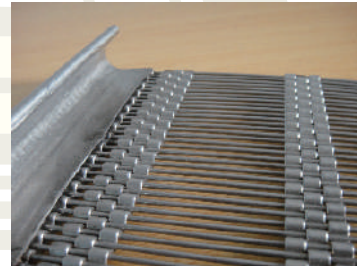

专利产品 Patent Product

菱形孔防堵筛网 Anti-clogging Rhombic Aperture Mesh

GW-9



专利产品 Patent Product

等腰三角孔防堵筛网 Anti-clogging Isosceles Triangle aperture Mesh

GW-10

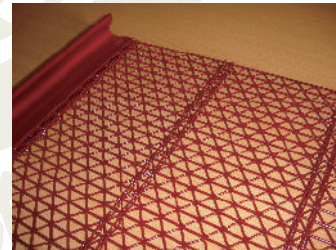

专利产品 Patent Product

筛分再生沥青筛网 Screen Specific for Renewing Asphalt

GW-11



专利产品 Patent Product

波纹孔防堵筛网 Anti-clogging Crimp Opening Mesh

GW-12



专利产品 Patent Product



盾牌筛网 坚固耐磨

DUNPAI SCREENS ROBUST AND WEAR RESISTANCE

上海盾牌矿筛有限公司

SHANGHAI DUNPAI MINERAL GIRD CO.,LTD

筛网常用弯边形式

Meshes with Regular Curved Edge

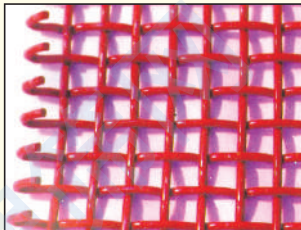

勾头 (适于丝径) $>4.5\text{mm}$
Hooking(wire dia. $>4.5\text{mm}$)

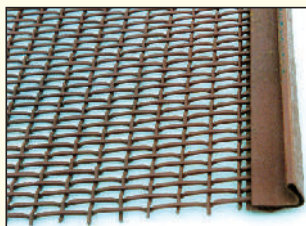

包边 (适于丝径) $\leq 6\text{mm}$
Wrapping(wire dia. $\leq 6\text{mm}$)



林泰阁机包边形式之一
One of Edges:Curved by Lintec Machine

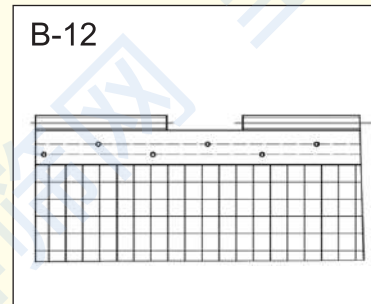
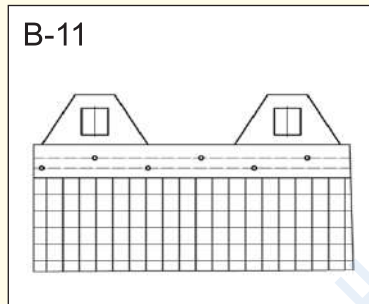
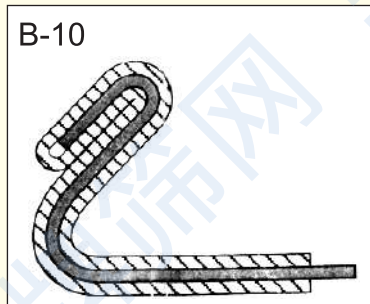
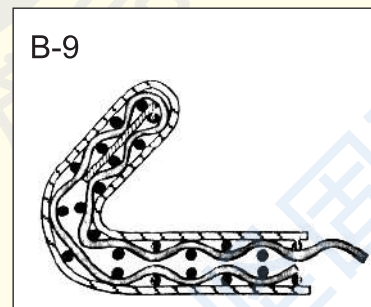
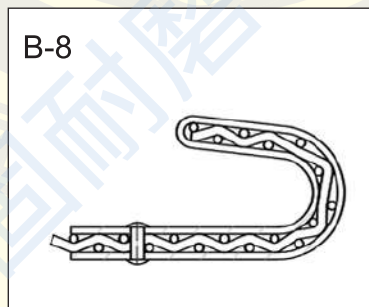
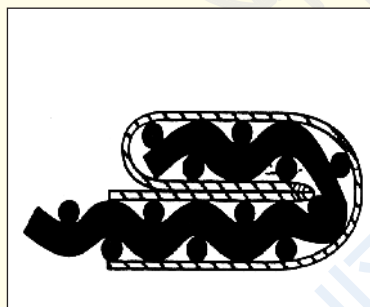
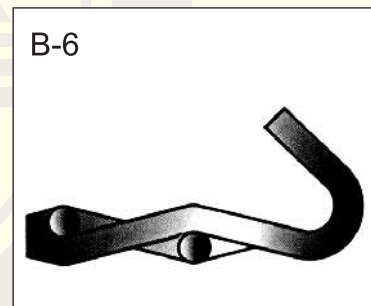
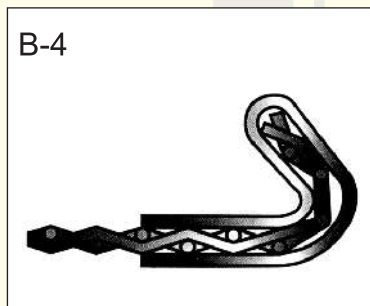
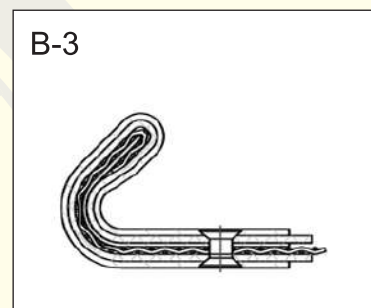
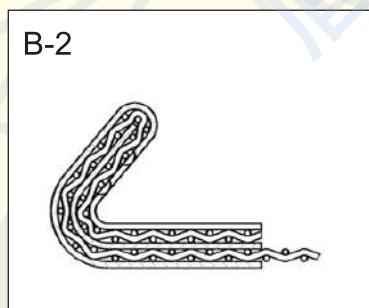
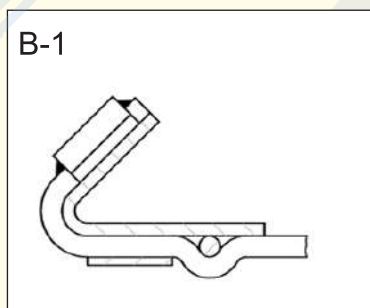



编织筛网安装须知

Installation Tips for Wire Weave Meshes

为了保证筛网的使用周期，耐磨钢丝编织筛网安装时必须拉紧。筛网的尺寸、弯边必须和筛机、张紧板的有关尺寸、形状相配套。如下图：

To ensure mesh's operation life, wire mesh must be installed under tension condition, and its size and curved edge have to be coordinated with relevant size and profile of tension board and sizing machine accordingly. See as below.

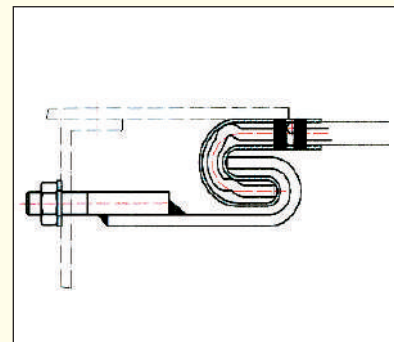
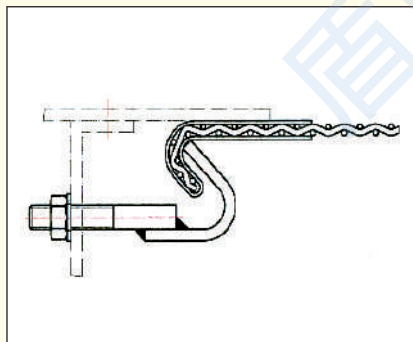
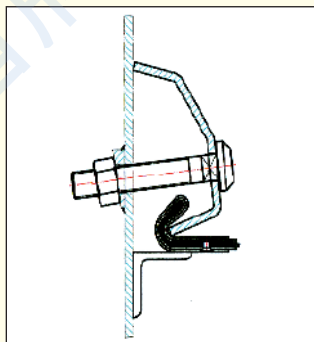

筛机宽度 Width of Sizing Machine (mm)	支撑梁数量及结构形式参考 Reference for Quantity and Type of Reinforcing Bar
600-1200	
1500-2100	
2100-3500	
<p>说明：支撑梁间距300-450毫米，间距大小主要是根据筛网强度、激振力的大小及筛面上物料的重量调整间距。 Notes: The clearance of supporting beams is set among between 300mm to 450mm which is depended on the screen strength needed, impulsing required and the load on the screen.</p>	



盾牌筛网 坚固耐磨

DUNPAI SCREENS ROBUST AND WEAR RESISTANCE

上海盾牌矿筛有限公司

SHANGHAI DUNPAI MINERAL GIRD CO.,LTD

冶金工业用筛网 Metallurgical Screen

我公司专为冶金工业提供各类耐磨筛网，采用特殊工艺、高耐磨材料制造。从1985年以后，为宝钢、马钢、沙钢等全国各大钢铁厂提供的陶瓷筛板、不堵孔的陶瓷筛板、悬臂筛板、水渣过滤网等，性能优异，使用周期长，满足各种筛分要求。

公司为炼铁厂生产的悬臂筛，筛上物含粉率仅2%，筛分效率达85%。经钢铁厂使用，对临界颗粒堵塞的自清理十分有效。

公司生产的陶瓷筛筛面，采用具有本公司专利的钢骨架耐磨筛条，结构合理、耐冲击、陶瓷耐磨层不易损坏，使用周期长。

公司代为测绘、设计、试制各种特殊筛网，并且为用户提供各种技术服务。

Our company specializes in providing all kinds of wear-resistant meshes for metallurgical industry. We have been professionally producing ceramic screens, anti-clogging ceramic screens, cantilever plates and water slag filters for Bao Steel Group and Maanshan steel company since 1985. The products are very welcomed by our customers.

The cantilever screen is also worked for the critical blocking situation in iron factories and shows its good self-cleaning performance. The powder content on the screen is only 2% and its screening efficiency is reached 85%.

The ceramic screen patented with reinforced wear-resisitant frame bars has a good configuration, impact resistance, its ceramic layer not vulnerable to be damaged and long serving life.

We are very welcomed to map, design and test any special screens if needed and provide technical services to our customers.

悬臂筛 Cantilever Screen

Y-1

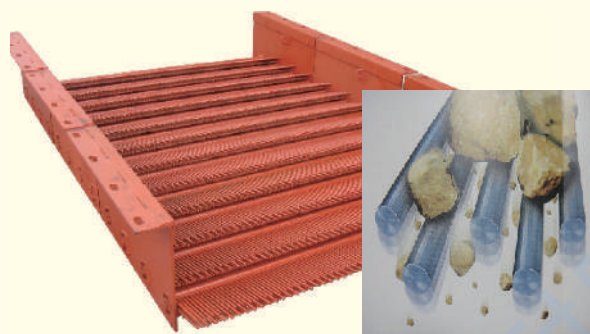

陶瓷耐磨层 Ceramic Screen With Tube Ceramic Wear Layer

Y-2



专利产品 Patent Product

钢骨架耐磨筛条 Ceramic Screen With Steel Framed Wear Bar

Y-3



专利产品 Patent Product

不堵孔的陶瓷筛网 Self-cleaning Ceramic Screen

Y-4



专利产品 Patent Product



盾牌筛网 坚固耐磨

DUNPAI SCREENS ROBUST AND WEAR RESISTANCE

上海盾牌矿筛有限公司

SHANGHAI DUNPAI MINERAL GIRD CO.,LTD

高炉转鼓支撑网、过滤网

Y-5

Reinforced Screen and Filtering Screen used in Blast furnace drum

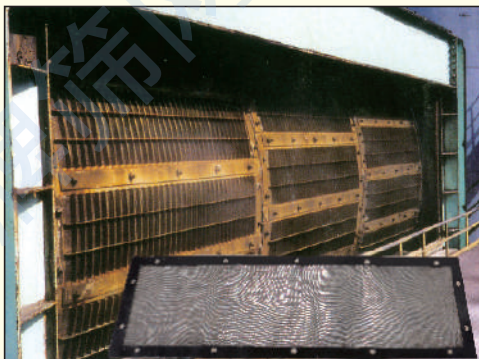

炼铁厂高炉喷煤系统硫化板

Y-6

Sulfur Board of Blast Furnace Coal Injection System in Iron works

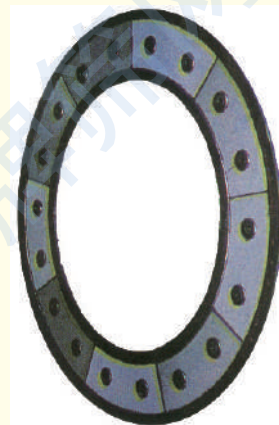

复合耐磨材料的格条筛

Y-7

Grill Screen with Compound Wear Material



高炉用文氏处理环（材质：工程塑料、铝合金）

Y-8

Venturi ring used in blast furnace (Materials:project plastics, aluminum alloy)



炼铁厂烧结料筛分筛板 Screen Board for Sinter Material in Iron Plant

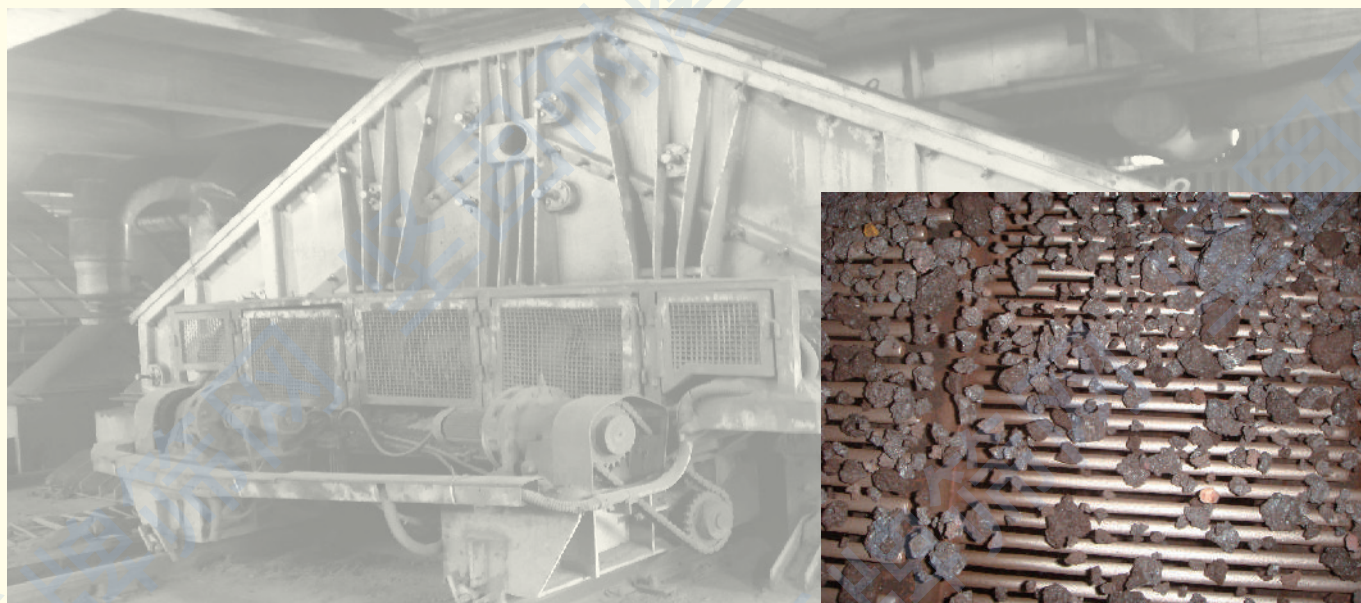



盾牌筛网 坚固耐磨

DUNPAI SCREENS ROBUST AND WEAR RESISTANCE

上海盾牌矿筛有限公司

SHANGHAI DUNPAI MINERAL GIRD CO.,LTD

非金属筛面

Non-metallic Screen

我公司生产的非金属筛网主要有聚氨酯筛网，筛板和橡胶筛网，筛板。其中，聚氨酯筛面材料采用国外进口原材料，先进智能型浇注设备满足了产品工艺性能要求。其筛面具有高耐磨、防堵孔与脱水效果好等特点。筛面采用通用化与模块化的结构，合零为整，安装简单，拆装方便，更换方便、节约成本和减轻劳动强度。主要用于选矿、隧道建设、水利工程的筛分过滤作业。

Non-metallic screens we made are polyurethane screens (boards) and rubber screens (boards), PU products are fabricated with imported material and casted by an advanced intelligent machine in order to meet processing requirements, they are of highly wear resistant, good in plugging proofness and dewatering, etc..The PU panel blocks are universal and modular structure with intergrated patterns, easily mount, dismount and replacement works are reduced in cost and labors. PU products are mainly used for sizing in mine washing, tunnel projects an water conservancy constructions.

分层压制的橡胶筛网 Pressed Laminating Rubber Screen

F-1

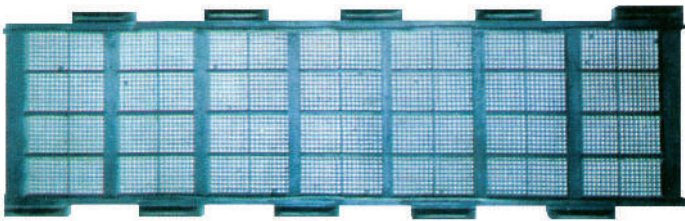

本筛网内含有扁钢焊接骨架，该形式用于石灰石的筛分作业。

The screen is constructed with flat steel welded frame, it is used for sizing limestone.

压制的橡胶筛网 Mould Pressed Rubber Screen

F-2

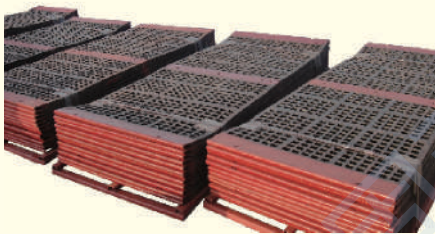

本筛网橡胶内含有金属钢丝绳的拉紧张紧安装形式。

Contained with steel wire to stress screen tightly under tension.

聚氨酯筛筛 Polyurethane Screen

F-3

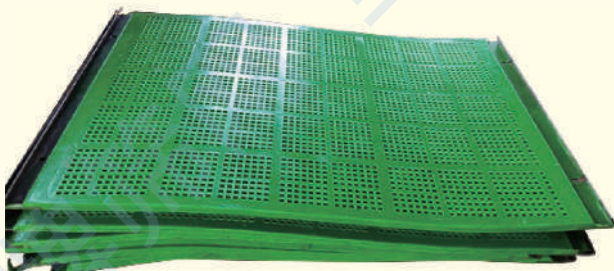

本筛网聚氨酯内含有金属钢丝绳的拉紧张紧安装形式。

Contained with steel wire to stress screen tightly under tension.



盾牌筛网 坚固耐磨

DUNPAI SCREENS ROBUST AND WEAR RESISTANCE

上海盾牌矿筛有限公司

SHANGHAI DUNPAI MINERAL GIRD CO.,LTD

橡胶钢条悬臂筛网 Cantilever Screen with Rubber Steel Strip

F-4



橡胶筛条内含有金属骨架。

The rubber screen bar is contained with steel frame.

聚氨酯条缝筛 Polyurethane Slotted Screen

F-5

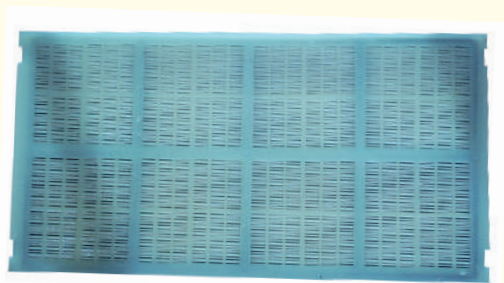

本筛网橡胶内含有金属钢丝绳的拉紧张紧安装形式。

Contained with steel wire to stress tightly under tension.

拼块式聚氨酯筛网 Modular Polyurethane Screen

F-6



本筛网内含有钢丝绳拉紧张紧安装形式。

Contained with steel wire to stress tightly under tension.

非金属筛网弯边示意图 Illustrations for Curved Edges of Non-metallic Screen

B-13

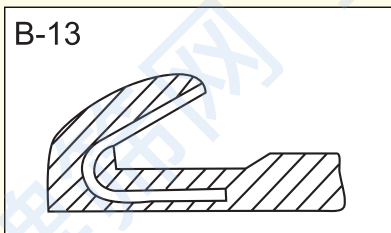

B-14

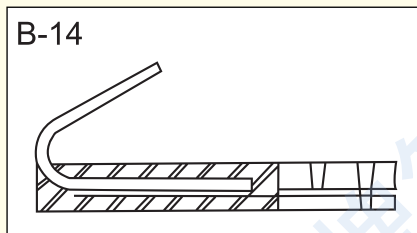

B-15

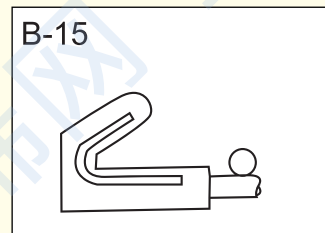



盾牌筛网 坚固耐磨

DUNPAI SCREENS ROBUST AND WEAR RESISTANCE

上海盾牌矿筛有限公司

SHANGHAI DUNPAI MINERAL GIRD CO.,LTD

组合式聚氨酯筛板

Modular Polyurethane Screen

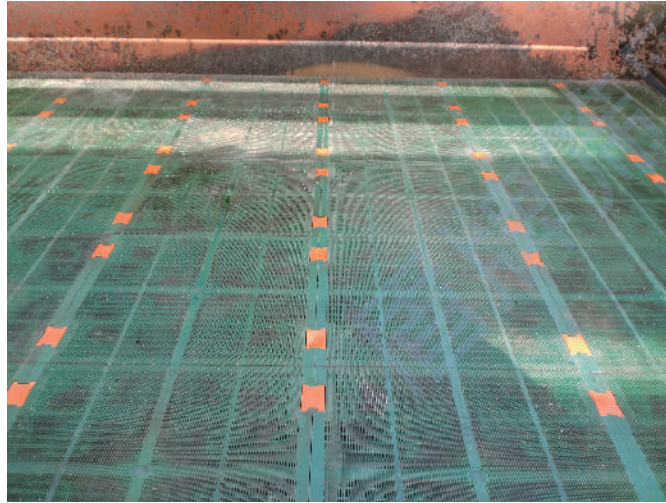

DP-J 型聚氨酯筛板有公制与英制两种单位尺寸。本说明书以公制为例。聚氨酯筛板一般模块尺寸为 305mm×305mm、305mm×610mm，其它尺寸一般围绕改尺寸进行开发。

DP-J type PU screen board has two measure units of Metric and Inches, metric unit is taken as below. Normal size of PU screen block is 305mm x 305mm and 305mm x 610mm, the specific size can be made based on the basic dimension.

支撑梁外型简图 Supporting Beam Profile



序号(S/N)	A(mm)	B(mm)	b(mm)
1	90	50	≥4 ~ ≤
2	80	40	≥4 ~ ≤
3	40	40	≥4 ~ ≤

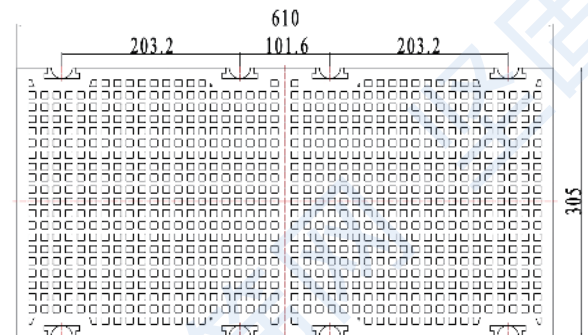
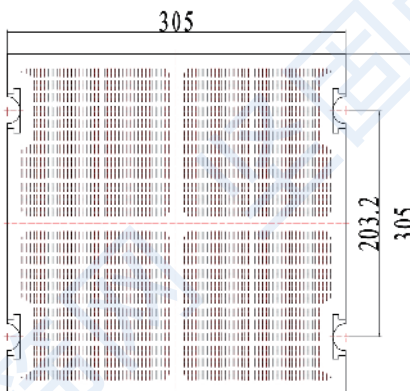

筛板安装结构图 Structural drawing of Screen Board Installation



盾牌筛网 坚固耐磨

DUNPAI SCREENS ROBUST AND WEAR RESISTANCE

上海盾牌矿筛有限公司

SHANGHAI DUNPAI MINERAL GIRD CO.,LTD

1、四波浪条缝筛板 Four-wave Slotted Screen

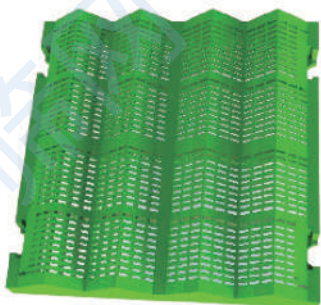

4、弹性防堵筛板 Elastic Anti-Clogging Board

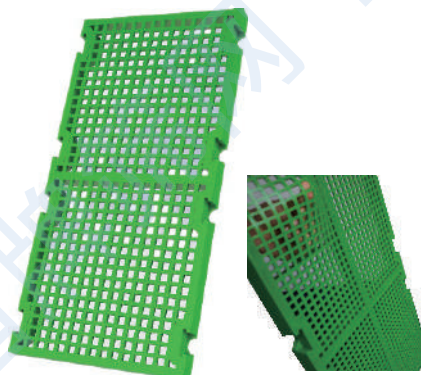

3、防堵筛板 Anti-clogging Board

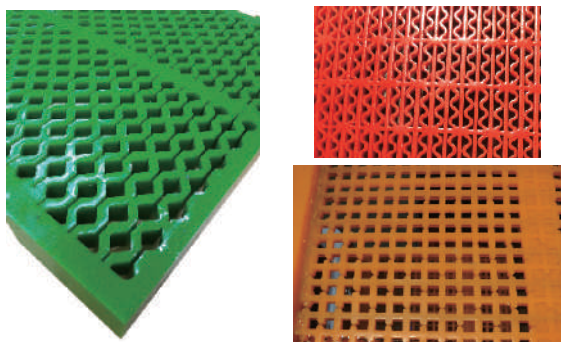

5、高效脱水筛板 High-efficient dewatering Board

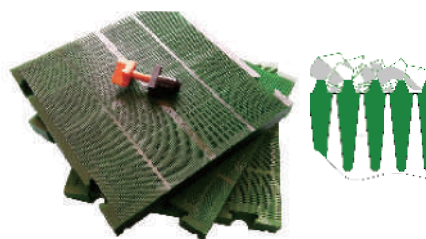

组合式橡胶筛板 Modular Rubber Screen Board

1、橡胶筛板 Rubber Screen Board

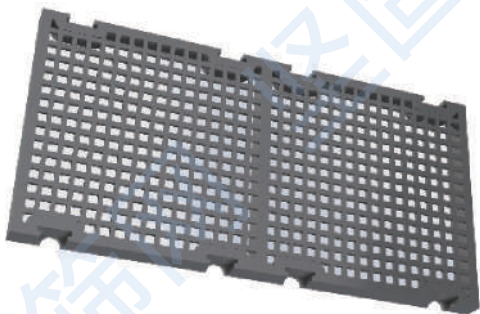

2、高弹性防堵筛板 High Elastic Anti-Clogging Board





盾牌筛网 坚固耐磨

DUNPAI SCREENS ROBUST AND WEAR RESISTANCE

上海盾牌矿筛有限公司

SHANGHAI DUNPAI MINERAL GIRD CO.,LTD

套边式聚氨酯筛板 Polyurethane Screen with Mounting Edges

1、小块筛网拼接套边 Small Block with Combined Mounting Edges



2、不锈钢条缝筛板套边 SS Slotted Screen with PU Mounting Edges

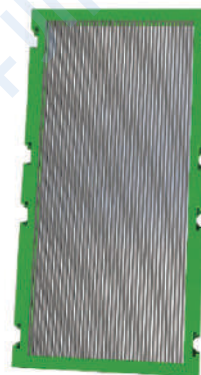

3、金属网套边 Metal Wire Screen with PU Mounting Edges

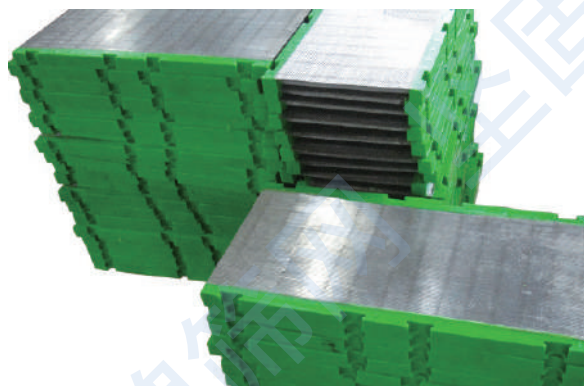
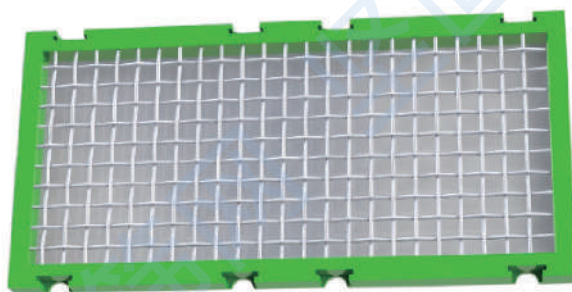
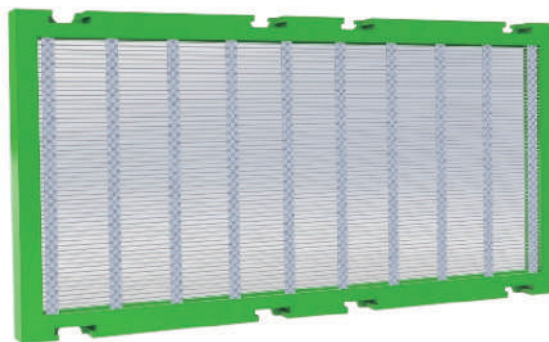
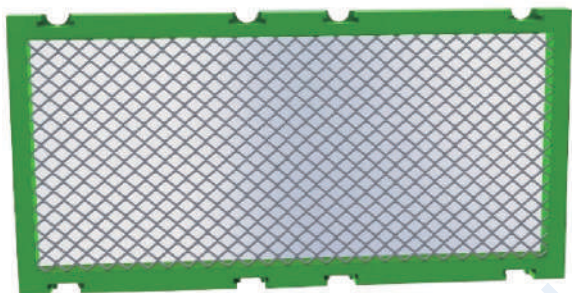



盾牌筛网 坚固耐磨

DUNPAI SCREENS ROBUST AND WEAR RESISTANCE

上海盾牌矿筛有限公司

SHANGHAI DUNPAI MINERAL GIRD CO.,LTD

筛机配件 Hardwares

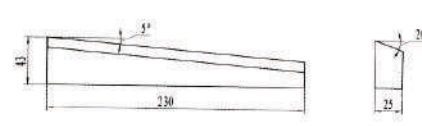
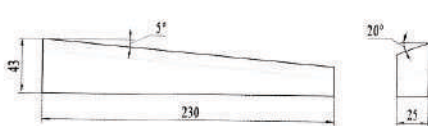
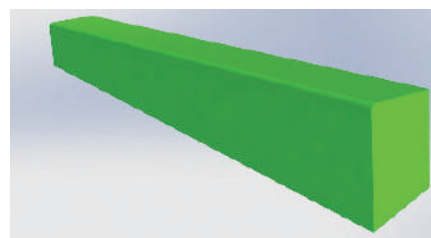
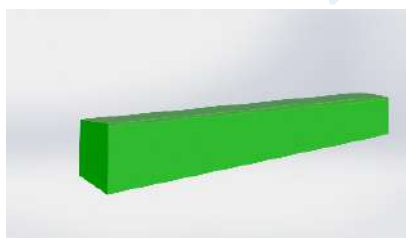
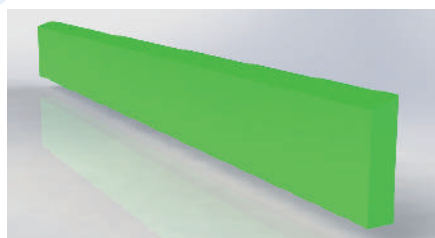
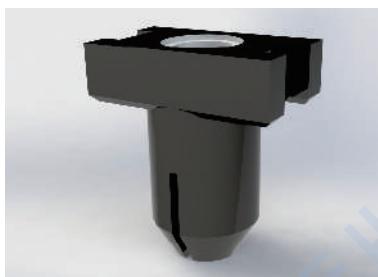

防堵棒 Impacting Bars





盾牌筛网 坚固耐磨

DUNPAI SCREENS ROBUST AND WEAR RESISTANCE

上海盾牌矿筛有限公司

SHANGHAI DUNPAI MINERAL GIRD CO.,LTD

输送带清理机构 Conveying Belt Cleaning Mechanism

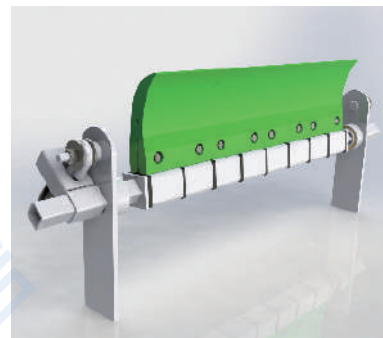
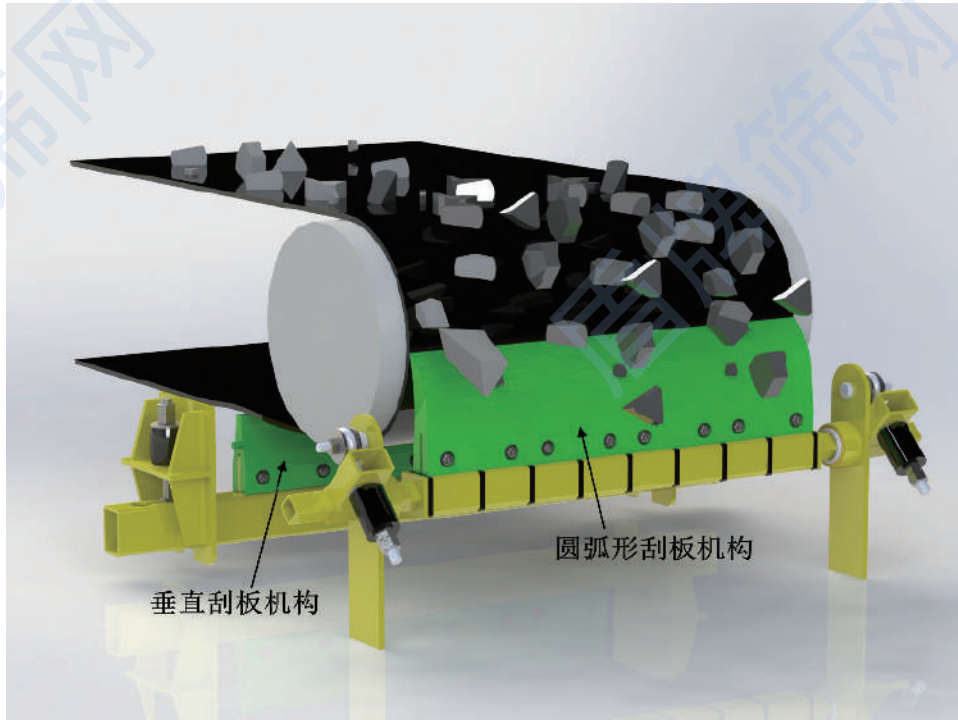

1、垂直刮板 Vertical Scraper

2、圆弧刮板 Arc Scraper





盾牌筛网 坚固耐磨

DUNPAI SCREENS ROBUST AND WEAR RESISTANCE

上海盾牌矿筛有限公司

SHANGHAI DUNPAI MINERAL GIRD CO.,LTD

各种喷嘴 Nozzles



1、鱼尾式喷嘴 Fish-Tailed Nozzle



特性:

1. 采用新型材料聚氨酯制作而成。
2. 对水质无要求。
3. 可循环用水。
4. 耐磨、耐酸碱。
5. 出水口径有 6mm、8mm、10mm 三种规格。
6. 水流成瀑布状。
7. 使用寿命长。

Features:

- 1.Manufactured with new type of PU material
- 2.Careless of water quality
- 3.Recirculating water applied
- 4.Wear resistance and acid-base resistance
- 5.There are three different spec, for outlet dim. :6mm, 8mm and 10mm
- 6.Outlet Fluid is of waterfall
- 7.Long operation life

2、圆柱式喷嘴 Cone Nozzle



用途:

适合用于采石场、煤矿等含泥沙的场合，以及需要冲洗的场合，一般水压在 3~5kg，水流量为口径 6mm 的 0.15m³/h、口径 8mm 的 0.27m³/h、口径 10mm 的 0.42m³/h。

Usages:

They are applied for sediment areas, e.g. quarry and coal mine, its water pressure is around 3 to 5Kg, water flow is 0.15M³/h @6mm outlet, 0.27m³/h @ 8mm outlet and 0.42m³/h @ 10mm outlet.



盾牌筛网 坚固耐磨

DUNPAI SCREENS ROBUST AND WEAR RESISTANCE

上海盾牌矿筛有限公司

SHANGHAI DUNPAI MINERAL GIRD CO.,LTD

振动筛机配件

Accessories of Vibrating Machine

我公司生产的各类振动筛机配件包括张紧板、张紧螺栓、橡胶垫条、振动筛机用橡胶弹簧等，产品质量稳定，性能可靠。

DUNPAI supplies accessories for all kinds of vibrating machine, such as, tension board, tension bolt, rubber pad and rubber spring, etc. with stability and reliable performance.

张紧板 Tension Board

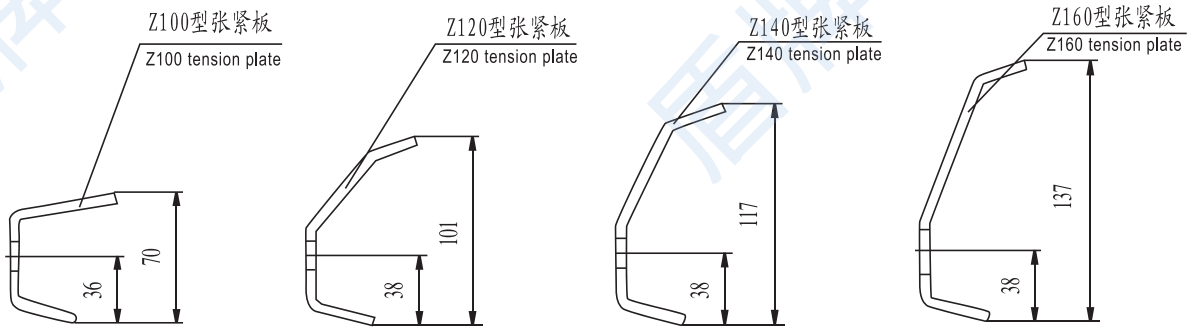

可按用户需求定制 customized per required.

普通张紧螺栓 Regular Tension Bolt

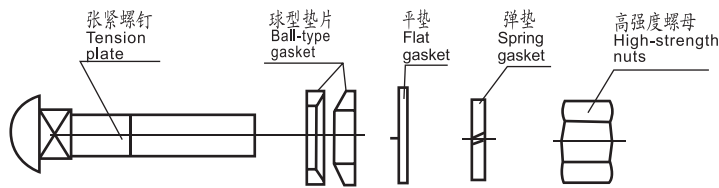

规格:
(Spec.)

M16×105×60; M16×110×80;
M16×130×60; M16×150×56;
M16×160×80; M20×130;
M20×140; M20×150; M20×160
M20×185; M20×195

恒力张紧钩 Constant Tension Hook



特点：能保证筛网的持续张紧状态

Its property is to keep tension status.

橡胶垫条 Rubber Cushion Strip

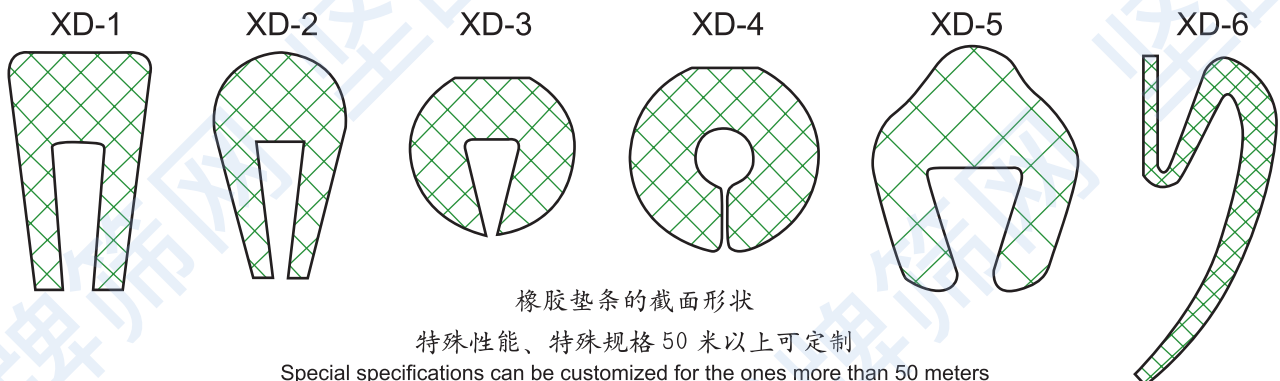

橡胶垫条的截面形状

特殊性能、特殊规格 50 米以上可定制

Special specifications can be customized for the ones more than 50 meters



盾牌筛网 坚固耐磨

DUNPAI SCREENS ROBUST AND WEAR RESISTANCE

上海盾牌矿筛有限公司

SHANGHAI DUNPAI MINERAL GIRD CO.,LTD

振动筛机用橡胶弹簧 Rubber Spring

橡胶弹簧的优点及特性 Advantage & Property of Rubber Spring

- ☆ 弹性模数远比金属小，可得到较大的弹性变形，容易实现理想的非线性特性；刚度可以根据设计要求自由选择。
- ☆ 具有较大阻尼，对于突然冲击和高频振动的息收益及隔音有良好的效果。
- ☆ 安装和拆卸方便，不需要润滑，有利于维修和保养。
- ☆ 小橡胶弹簧具有宽频带抑制噪音的特性，因此，其工作噪音比金属螺旋弹簧小。

- ☆ its Elastic modulus is far smaller than that of metal, and it is deformable as much as it can be obtained resulting in easily achieved ideal non-linear characteristic; the stiffness can be freely selected according to design requirement.
- ☆ With greater damping of the rubber spring, it is better to absorb sudden impact and hi-frequent vibrating and has a good effect in isolating from sound or noise, too.
- ☆ Easily install and remove, no need to lubricate, accessible for repair & maintenance.
- ☆ Due to it has a property of wide-band frequent inhibition noise, its working noise level is much lower than that of metal coil spring.



纯橡胶弹簧

Pure Rubber Spring

复合橡胶弹簧

Composite Rubber Spring

振动筛机专用圆柱纯橡胶弹簧技术参数表 Technical Parameters of Cylinder Pure Rubber Spring Typically used in Vibration Machine

型号 TYPE	外径 OD(mm)	内径 ID(mm)	高度 H(mm)	推荐高度 Recommended Height (mm)	工作直径 Work Dia. (mm)	定位芯 Position Hole	弹簧承载负荷 Kg/cm
DP120	120	30	120	96-102	140	24	244-400
DP140	140	30	140	112-119	165	24	400-600
DP160	160	40	160	128-136	188	32	600-850
DP180	180	40	180	144-153	208	32	850-1200
DP200	200	50	200	160-170	230	40	1200-1500
DP220	220	50	220	176-187	252	40	1500-2000
DP240	240	50	240	192-204	275	40	2000-2600

本公司对所有资料保留修改权利 DUNPAI reserves rights to modify all informations.

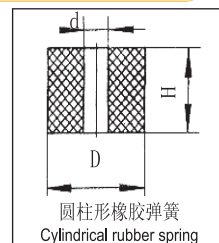

圆柱形橡胶弹簧
Cylindrical rubber spring

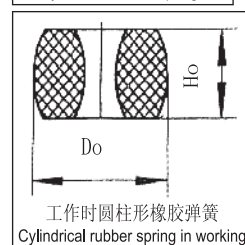

工作时圆柱形橡胶弹簧
Cylindrical rubber spring in working

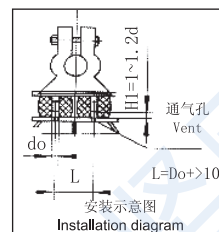

安装示意图
Installation diagram

纯橡胶弹簧选用的计算方法 Calculations for selecting pure rubber springs

- 1、橡胶弹簧的压缩率为 15-20% (取 17%)
 - 2、刚度的选择：参振重量为 100% 弹簧数量的承重。
(注：参振重量不考虑筛选物料重量)
- 计算举例：一台振动筛，参振重量 1.8 吨，用四个橡胶弹簧 $1.8 \div 4 = 0.45$ 吨，查表为 DP140，压缩率取 17%， $140 \times 0.17 = 23.8$ mm，刚度为 $450 \div 2.38 = 189$ KG/cm。
($H_o = 140 - 23.8 = 116.2$ mm)

- 1.Spring compression rate 15-20% (take 17%)
- 2.Choice of stiffness: Participating vibration weight is the load on all springs (notes: the weight of material is not considered).
for example: a vibrating machine, joining weights: 1.8 tons, four rubber springs $1.8/4 = 0.45$ tons, referring to DP140 in the table, compressibility is 17%, $140 \times 0.17 = 23.8$ mm, Stiffness is $450/2.38 = 189$ KG/cm ($H_o = 140 - 23.8 = 116.2$ mm.)

本公司可根据用户对橡胶弹簧的特殊要求进行设计、制造。

Design and fabrication can be made based on customer special requirement on rubber spring.



盾牌筛网 坚固耐磨

DUNPAI SCREENS ROBUST AND WEAR RESISTANCE

上海盾牌筛网滤器有限公司

SHANGHAI DUNPAI WIRE MESH & FILTERING CO., LTD

条缝筛板及筛篮 Slotted SS Plate & Centrifuge SS Basket

我公司专业生产各类条缝筛板、离心机筛篮等。产品采用优质高强度不锈钢耐磨材料制造，焊接工艺先进，测试手段严格，适用领域广泛。公司生产的高强度耐磨不锈钢无磁筛板，采用特殊无磁材料和先进的去磁工艺，适用于要求严格的无磁生产流程。

公司代为测绘、设计、试制各种特殊筛网，并且为用户提供各种技术服务。

DUNPAI is specializing in producing a wide range of slotted screens and centrifuge sifting baskets with high-grade quality and high strength material, hi-tech welding process and strict testing method are utilized in manufacturing the screens. DUNPAI non-magnetic SS screen boards are made of special non-magnetic material and processed with an advanced de-magnetic process, they are suitably used for strictly required non-magnetic production.

We are very welcomed to mapping, designing and testing for our customers in any products with special requirements.

穿条式条缝筛板 Over-strip Slotted Screen Board

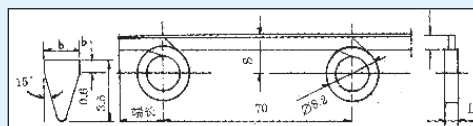
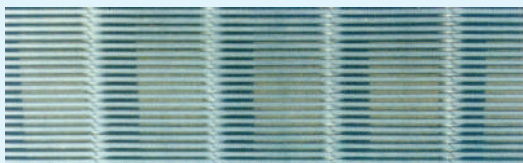

焊接式条缝筛板 Welded and Slotted Screen Board

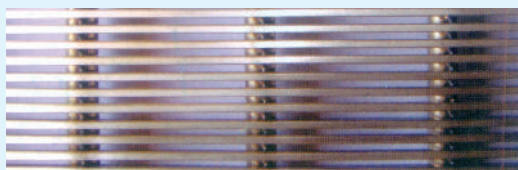

弧形筛 Arc Screen

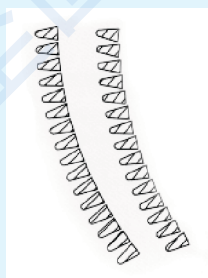
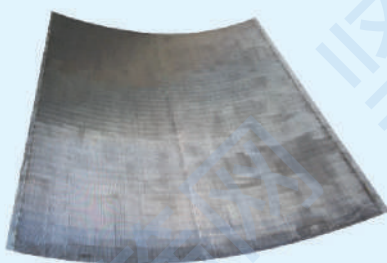

离心机筛篮 Centrifuge Screen Tommel

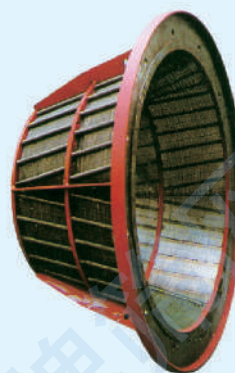



盾牌筛网 坚固耐磨

DUNPAI SCREENS ROBUST AND WEAR RESISTANCE

上海盾牌筛网滤器有限公司

SHANGHAI DUNPAI WIRE MESH & FILTERING CO., LTD

不锈钢高强度无磁筛板 High-strength Non-magnetic Stainless Steel Screen Board



特点：
强度高，耐磨性好，无磁性。

Features:
High strength, highly wear resistant and non magnetization.

挤干机筛网 Extruder Screen

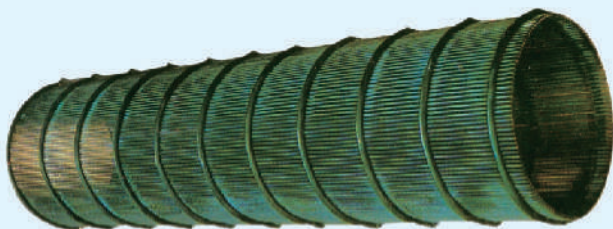

特点：
挤干效率高，滤净率好。

Features:
High efficiency in extruding and filtering.

滚动筛 Rotating Screen

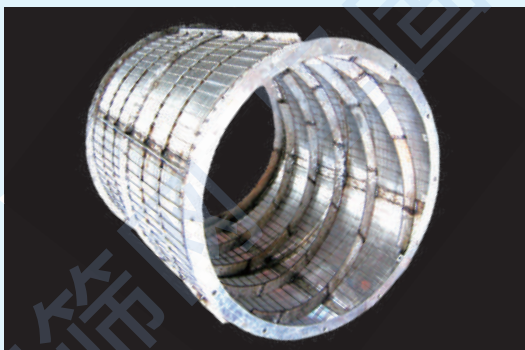

特点：
此筛用于焦化厂德式锅棒磨机滚动筛中，筛分效率高，使用周期长。

Features:
The screen is typically used in Texaco furnace roller milling machine with result of high classifying efficiency and long operational life.



盾牌筛网 坚固耐磨

DUNPAI SCREENS ROBUST AND WEAR RESISTANCE

上海盾牌筛网滤器有限公司

SHANGHAI DUNPAI WIRE MESH&FILTERING CO.,LTD

过滤器 Filters

我厂生产的过滤器及滤芯，采用进口高精度不锈钢滤材，引进国外先进生产设备，经特殊工艺精细加工，过滤精度高，整体刚度好，结构强度高，安装、调换方便。产品质量完全达到 ISO 标准。性能稳定，使用周期长，可用于精细化工、冶金、饮料、精密液压系统、石化、化纤等领域。

我公司接受特殊规格订货

Filters and filtering cartridges produced by DUNPAI are made of high-precise SS material and fabricated with special precise process, apart from its good integral stiffness and firm structure, they are easily got installed and replaced, too. The quality is toally satisfied with ISO Standards. As the stability performance and long life, they are widely spreaded into fine chemical industry, metallurgy, beverage, precise hydraulic system, petro-chemical and fiber fields. Any special spec. orders can be performed by us.

DPF 系列熔体滤芯 DPF series Melt Filter Cartridges

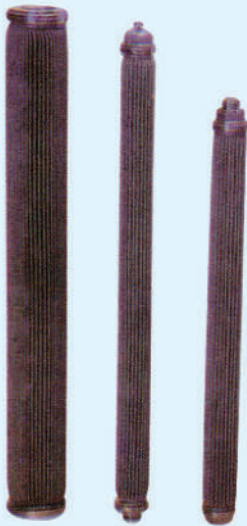

主要技术指标:

- 1 过滤精度范围: 3微米-60微米以上
- 2 过滤介质粘度最高可达3000泊
- 3 工作条件: 温度 $\leq 320^{\circ}\text{C}$ 压力 $\leq 32\text{Mpa}$, 切换压差6-7Mpa
- 4 正确清洗条件下, 可重复使用次数 ≥ 8 次

Main Technical Indicators:

- 1.The range of filtering accuracy:3micron to more than 60 micron
- 2.Filtering medium viscosity max.up to 3,000p
- 3.Work conditions:temperature: $\leq 320^{\circ}\text{C}$,pressure: $\leq 32\text{mpa}$,convert pressure differential:6 to 7mpa
- 4.Reusable more than 8 times if proper cleaning work is available.

篮式过滤器 Basket Filters

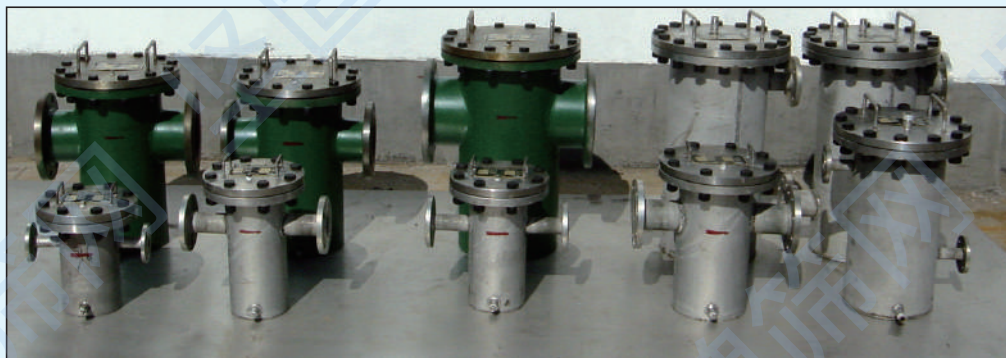



盾牌筛网 坚固耐磨

DUNPAI SCREENS ROBUST AND WEAR RESISTANCE

上海盾牌筛网滤器有限公司

SHANGHAI DUNPAI WIRE MESH&FILTERING CO.,LTD

硫化盘 Sulphur Board

过滤器 Filtering Plate

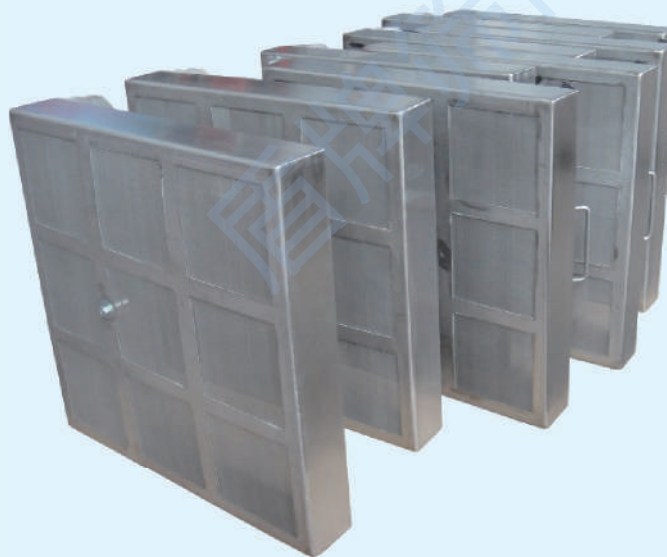
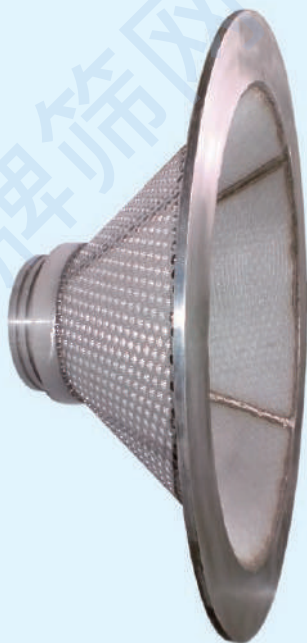

各种非标过滤器 Various Non-standard Filters





盾牌筛网 坚固耐磨

DUNPAI SCREENS ROBUST AND WEAR RESISTANCE

上海上盾筛分设备有限公司

SHANGHAI SHANGDUN SIZING EQUIPMENT CO.,LTD

振动筛机 Vibrating Machine

我公司是各类振动筛机及耐磨筛网的专业生产厂、中国重型工业机械协会会员。主要生产各类圆振动筛、直线振动筛、振网筛、平面旋转筛、共振筛、旋振筛及复合肥专用筛等。由于采用橡胶弹簧，整机噪音小、运转平稳。公司拥有专业队伍维修改制各类筛分机械。

We professionally produce various wear meshes and vibrating machine. We are the member of CHMIA(China Heavy Machinery Industry Association). The main products are circular sieve, linear sieve, vibrating sieve, plane rotary sieve, resonance sieve, spin-vibrating sieve and compound fertilizer sieve. The sieves are of small noise and stable in operation due to applying with rubber spring.

We have professional technical team to repair and maintain all kinds of sizing equipment.

圆振动筛 Circular Vibrating Machine



直线振动筛 Linear Vibrating Machine

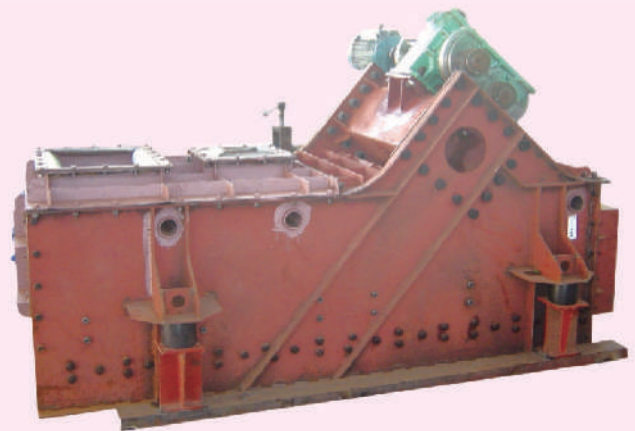

平面旋转筛 Flat Rotating Machine



共振筛 Resonant Machine

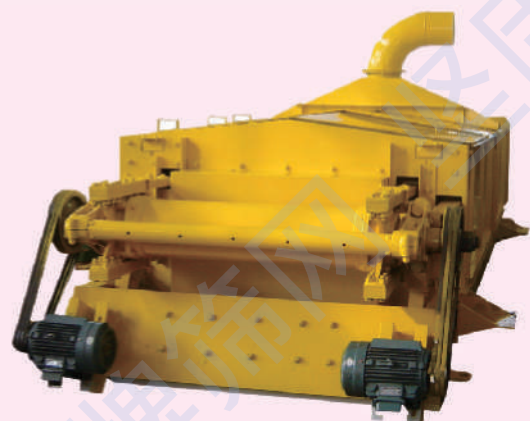



盾牌筛网 坚固耐磨

DUNPAI SCREENS ROBUST AND WEAR RESISTANCE

上海上盾筛分设备有限公司

SHANGHAI SHANGDUN SIZING EQUIPMENT CO.,LTD

概率筛 Probability Sizing Machine



曲臂筛 Crank-arm Vibrating Machine



分样试验筛 Sampling Screen



易清理的复合肥专用筛 Easily Clean-up Screen for Compound Fertilizer

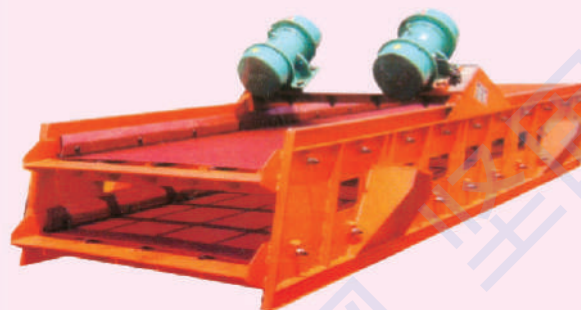



盾牌筛网 坚固耐磨

DUNPAI SCREENS ROBUST AND WEAR RESISTANCE

上海上盾筛分设备有限公司

SHANGHAI SHANGDUN SIZING EQUIPMENT CO.,LTD

振动筛机主要参数 Main Parameters of Vibrating Machine

种类 Kinds	型号 type	筛网层数 No.of deck	筛网面积 area (m ²)	处理量 handling capacity (t/h)	振动频率 frequency (r/min)	双振幅 double amplitude (mm)	电机功率 power (kw)	外形尺寸(长*宽*高) outline of dimension (L×W×H)	重量 weight (Kg)
矿用单轴振动筛 Mineral single-axis vibrating screen	2DD918	2	1.6	10-80	1000	5-6	2.2	2200×1418×630	600
	2ZD918	2	1.6	10-80	1000	6	2.2	2200×1418×630	620
	2ZD1224	2	2.9	60-180	850	6-7	4	2600×2200×1780	1545
	2ZD1530	2	4.5	90-300	850	6-7	5.5	3200×2690×2250	2260
	2ZD1540	2	6	125-380	850	7	7.5	4200×2600×2733	2850
	ZD1836	1	6.5	135-440	850	7	11	3670×2990×1807	1970
自定中心振动筛 Self-centering vibrating screen	SZZ ₂ 800X1600	2	1.3	8-45	1430	6	3	1935×1678×1345	822
	SZZ ₂ 1250X2500	2	3.1	36-117	1200	2-6	5.5	2635×2376×1873	1405
	SZZ ₂ 1250X4000	2	5	58-188	900	2-6	7.5	4184×2468×3146	2500
	SZZ ₂ 1500X3000	2	4.5	52-170	840	5-10	7.5	3050×2524×1907	2700
	SZZ ₂ 1500X4000	2	6	70-227	800	7	7.5	4155×2754×2656	4022
	SZZ1800X3600	1	6.48	76-245	750	8	18.5	3750×3060×2541	4626
圆振动筛 Circular vibrating screen	2YK1230	2	3.6	233	970	6-10	11		3128*
	2YK1445	2	6.3	272	970	6-10	18.5		4900*
	2YK1645	2	7.2	310	970	6-10	18.5		5750*
	2YK1845	2	8.1	524	740	12-14	22		6680*
直线振动筛 Linear vibrating screen	2ZB918	2	1.6		960	7	0.75×2	2150×1418×930	600
	ZB1224	1	2.8		960	4-6	2.5	3340×1800×1350	1500
	2ZB1232	2	3.8		960	7-8	2.2×2	3320×1800×1500	1665

注：重量中带*者为参振重量 *Note:Asterisk in weight column is participating weight

干粉砂浆双层复合筛网 Double-Deck Compound Screen for Dry Slag

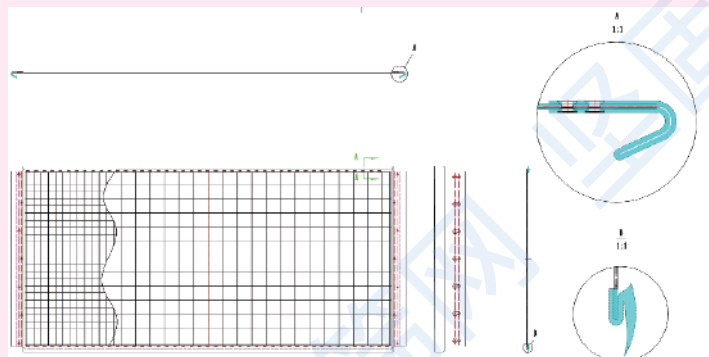



盾牌筛网 坚固耐磨

DUNPAI SCREENS ROBUST AND WEAR RESISTANCE

上海上盾筛分设备有限公司

SHANGHAI SHANGDUN SIZING EQUIPMENT CO.,LTD

旋振筛 Rotary Vibrating Machine

旋振筛是一种新型的高精度细粒筛分机械，其性能达到国外同类型筛的先进水平。该筛由特制立式振动电机激振，筛体的振动轨迹是一复旋型的空间三维曲线，筛机全封闭无泄漏。广泛应用于化工、食品、矿业等行业的筛分作业。

The rotary vibrating screen is a newly type and highly precision machine used for sizing fine particles material, the performance can reach to the same advanced technical requirement required in similar type of machine. A special vertical vibrating motor is installed to excite vibration, the vibrating trace of the screen is a complex-spiral spaced three-dimension curve. The machine is of entire enclosure and non-leakage unit and widely used un chemical, food and mine industries.

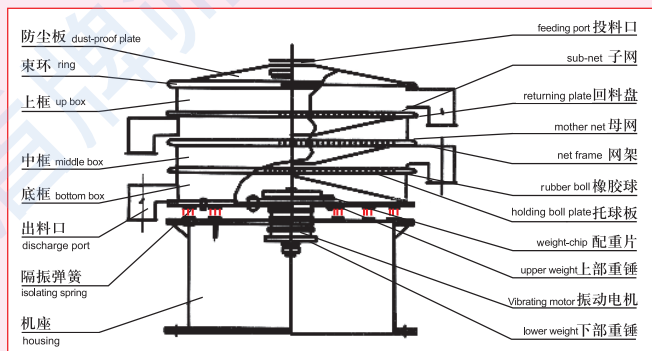

S49 系列工作原理 S49 Series Operating Principle

原料运动方向 Direction of movement of raw materials	重锤相位角 Weight phase angle	特点 Characteristics	主要用途 Main purpose
	5°	原料是由中心直线流向圆周方向 Raw material flows straightly to circular direction from center.	概略分级, 将易于筛分的原料作为大量分级粗略的筛分 General classification means the easily screened raw material is regarded as a big volume of preliminary screening material.
	15°	开始涡流运动 Starting cyclonic movement	用于一般筛分 For normal sizing
	80°	最长的涡流运动 The longest cyclonic movement	精细分级, 用于微粉, 高凝聚性及高含水率之原料分级 Fine grading, used for sizing material such as fine powder, high viscosity and highly moisture raw material.
	90° 以上	原料中央集中 raw material is collected in central spot	特别用途 special purpose

特点 Features

- 体积小, 移动方便
- 可用于干式和湿式筛分, 筛分效率高
- 密封性能好, 无泄漏; 换网快捷, 清洗方便。
- 调节偏心块相位角, 可改变物料运动轨迹。
- 筛分颗粒最细可达400目, 对易堵孔物料可用橡胶球击打。
- 筛网最多用四层, 可根据生产工艺需要选择。
- Compact in size, convenient to be moved.
- Used for dry and wet material sizing with high efficiency.
- Tightly sealed and non leakage, screen quickly replaced and easily accessed to clean.
- Material flow trace can be changed by adjusting phase angle of eccentric.
- The minimum size of classified particles can reach to 400 mesh, as to the material being easily clogged screen can be pounced by rubber balls.
- The numbers of deck are depended an production process, the maximum four decks are allowed.

S49 系列旋振筛性能及参数 Performance and Parameters of S49 series Rotary Vibrating Screen

型号 Type	S493	S494	S495	S496.3	S4910	S4916	S4925
公称直径 Nominal dia.(mm)	φ 300	φ 400	φ 500	φ 630	φ 1000	φ 1600	φ 2500
层数 Deck	1-3	1-3	1-3	1-3	1-3	1-3	1-3
有效筛面直径 Effective dia.(mm)	φ 200	φ 300	φ 400	φ 514	φ 900	φ 1450	φ 2300
有效筛面面积 Effective area(m ²)	0.025	0.071	0.19	0.21	0.64	1.65	4.15
网目 Mesh	2-325	2-325	2-325	2-325	2-325	2-325	2-325
物料粒度 Material size(mm)	< φ 20	< φ 20	< φ 20	< φ 30	< φ 30	< φ 50	< φ 50
振次 Frequency(次/分)	1500	1500	1500	1500	1500	1500	1500
功率 power(Kw)	0.18	0.2	0.25	0.5	0.75(1.5)	1.5(2.2)	3.7



盾牌筛网 坚固耐磨

DUNPAI SCREENS ROBUST AND WEAR RESISTANCE

上海上盾筛分设备有限公司

SHANGHAI SHANGDUN SIZING EQUIPMENT CO.,LTD

S49 系列旋振筛安装尺寸参考值 Reference Dimensions of S49 series Rotary Vibrating Screen

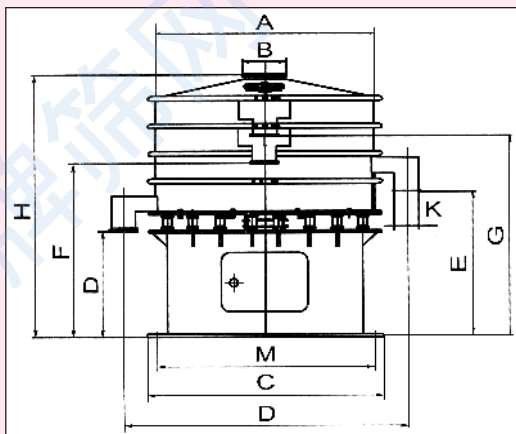

尺寸 dimension(mm)	型号 type	S493	S494	S496.3	S4910	S4916	S4925
A		φ 300	φ 400	φ 630	φ 1000	φ 1600	φ 2500
B		φ 60	φ 80	φ 120	φ 180	φ 250	φ 350
C		φ 350	φ 450	φ 700	φ 1080	φ 1700	φ 2620
D		300	450	500	570	650	750
E	单层 (1deck)	360	560	630	720	840	960
	双层 (2deck)	360	560	630	720	840	960
	三层 (3deck)						
F	单层 (1deck)						
	双层 (2deck)	410	660	750	860	1020	1160
	三层 (3deck)	410	660	750	860	1020	1160
G	单层 (1deck)						
	双层 (2deck)						
	三层 (3deck)	460	760	870	1000	1200	1360
H	单层 (1deck)	500	710	850	950	1090	1220
	双层 (2deck)	550	810	970	1090	1270	1420
	三层 (3deck)	600	910	1090	1230	1450	1620
K		φ 40	φ 60	φ 80	φ 110	φ 150	φ 200
M		φ 300	φ 400	φ 630	φ 1000	φ 1600	φ 2500
N		4-φ 20	6-φ 20	6-φ 25	6-φ 30	8-φ 30	8-φ 35
Q		φ 400	φ 565	φ 890	φ 1414	φ 2262	φ 3535

S49 系列旋振筛性能及参数 Performance and Parameters of S49 series Rotary Vibrating Screen

序号	原料 raw material	比重 density	网目 wire mesh	办法 method	处理量每小时 handling capacity
1	奶粉 Milk	0.7	16	干	2000Kgs
2	砂糖 Sugar	1.05	4	干	5000Kgs
3	面粉 flour	0.6	20	干	5000Kgs
4	酵母液 Yeast liquid	0.5	30	湿	8000L
5	米粉 Rice	0.8	100	干	500Kgs
6	豆腐 Tofu	1.0	125	湿	2500L
7	玉米淀粉 Corn starch	0.6	40	干	2000Kgs
8	橙汁 Orange juice	1	3	湿	5000L
9	梨汁 Pear juice	1	80	湿	5000L
10	中药粉 Chinese medicine powder	0.6	80	干	1400Kgs
11	西药粉 Western medicine powder	0.7	80	干	600Kgs
12	药液 Medicine liquid	1.0	18	湿	3000L
13	农药 Pesticides	80	干	1000Kgs	
14	环氧树脂 Epoxy resin	1.8	80	干	350Kgs
15	尿酸树脂 Ureine-formaldehyde resin	0.6	40	干	1000Kgs
16	聚乙烯树脂 Polyethylene resin	0.5	60	干	500Kgs
17	聚合粒 Polymerization tablets	1.05	10	干	5000Kgs
18	非磁色料 Non-magnetic pigment	0.5	60	干	300Kgs
19	聚酯粉涂料 Polyester powder coating	0.8	100	干	500Kgs
20	涂料 Paint	0.7	100	湿	7500Kgs
21	喷雾土粒 Soil spray	2.0	10	干	18000Kgs
22	泥浆 Mud	1.1	250	湿	3500L
23	长石 Feldspar	2.5	18	干	5000Kgs
24	研磨材料 Abrasive material	1.5	250	干	1000Kgs

序号	原料 raw material	比重 density	网目 wire mesh	办法 method	处理量每小时 handling capacity
25	人造黑铅 Human-made lead	1.2	30	干	1500Kgs
26	高岭土 GaoLing Soil	0.4	100	干	300Kgs
27	生石灰 Quicklime	2.5	100	干	500Kgs
28	沸石 Zeolite	0.8	5	干	1000Kgs
29	氧化铅 Lead oxide	1	120	干	250Kgs
30	碳化硅 Silicon carbide	1.7	325	干	200Kgs
31	硫磺 Sulfur	2.0	80	干	500Kgs
32	铅粉 lead powder	11	40	干	1000Kgs
33	金刚砂 Carborundum	4	60	干	500Kgs
34	焊条粉 Powder electrode	0.95	200	干	550Kgs
35	石墨 Graphite	1.2	40	干	1500Kgs
36	陶瓷浆 Ceramic slurry	1.2	120	湿	10000Kgs
37	废水 Waste Water	1	60	湿	25000L
38	废油 Waste oil	0.9	100	湿	20000L
39	燃料废水 Fuel waste water	1	100	湿	30000L
40	石粉 Powder		40	干	1200Kgs
41	颜料粉末 Pigment powder		20	干	3500Kgs
42	蔗糖除蔗纤维 In addition to sugar cane fiber		150	湿	5000Kgs
43	轻质碳酸钙 PCC		100	干	800Kgs
44	还原铁粉 Reduced iron powder		60	干	2400Kgs
45	稀有金属粉 Rare metal powder		100	干	1200Kgs
46	铸造型砂 Foundry sand		8	干	7000Kgs
47	WPL200钢粉 WPL200 steel powder		45	干	2700Kgs
48	NiMo1钢粉 NiMo1 steel powder		75	干	2100Kgs



盾牌筛网 坚固耐磨

DUNPAI SCREENS ROBUST AND WEAR RESISTANCE



辉煌的业绩 Brilliant Achievements

1. 公司为全国的钢铁企业提供各类筛网，如：

上海宝山钢铁股份有限公司
马鞍山钢铁股份有限公司
宝钢湛江钢铁有限公司
水城钢铁集团有限公司

1. Supplying with a various of type of screens to iron and steel enterprises in china, such as:

Bao Iron & Steel Groups
Maanshan Iron & Steel Co.,Ltd
Zhanjiang Iron & Steel Co.,Ltd (Bao Steel)
ShuiCheng Iron & Steel Co.,Ltd

2. 公司为全国筑路机械和筛分设备生产厂配套各种筛网（排列部分前后），如：

山特维克矿山工程机械贸易有限公司
安迈工程设备有限公司
斯贝柯机械有限公司
徐州工程机械科技有限公司
美卓矿机有限公司
南方路面机械厂
亚龙筑机
廊坊玛连尼法亚机械有限公司
廊坊德基机械有限公司
北京加隆工程机械有限公司
吉林省公路机械有限公司
无锡雪桃集团有限公司
辽阳筑路机械有限公司
特雷克斯
凯斯特
日工工程机械有限公司
三一集团
江阴鑫海公路机械材料有限公司

2. Supplying with auxilliary screens to road construction machinery companies and sizing equipment manufacturers in China, they are:

SANDVIK
AMMANN
SPECO Machinery Co.,Ltd
XCMG SCIENCE AND TECHNOLOGY COMPANY
METSO
NFLG
YLRCM
MARINI-FAYAT
D&G MACHINERY
CA-LONG
Jilin Road Machinery Co.,Ltd
Wuxi Xuetao Groups Co.,Ltd
Liaoyang Road Construction Co.,Ltd
TEREX
KEESTRACK
NIKKO GROUP
SANY
Jiang Xinhai Highway Machine Material Co., Ltd

3. 产品销往海外的国家：

西班牙、俄罗斯、印度、肯尼亚、英国等

3. Overseas:

Spain, Russia, India, Kenya, UK, etc.